

**CLEANING
TOOLS &
TECHNOLOGIES**

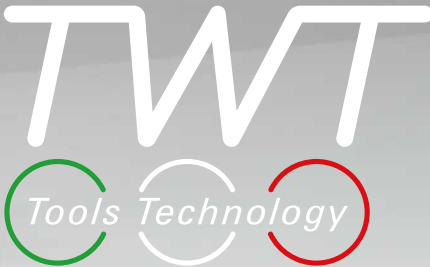



“ *Tutti dicono quello che fanno. Pochi fanno quello che dicono.* ”

Sergio Cervellin

CEO
TWT srl

CLEANING TECHNOLOGY

TWT loves standing out and working with modern, innovative and functional tools. Each product is designed with attention to ergonomics, using the newest technologies in order to make work easier and improve the performances.

Excellence in technologies. Brilliant performances.

TWT offers 100% Made in Italy tools and technologies with a modern design and extremely functional and innovative, thus responding to current product standards in terms of ergonomics, resistance, efficiency and attention to the environment.

Sensational looks. Style is not a luxury.

Attention to details is important. Style and forms communicate the quality of your work and your organization. In TWT, technology and design come together in a perfect balance creating a new style applied to professional cleaning.

Innovation and experience. Tailored for you.

Our experience and technical expertise are at your service. Our creed is the craftsmanship and efficiency that have made the fortune of Made in Italy companies and the satisfaction of their customers.

Each to his own: to us the products, to you the solutions.

In a world where everybody sells solutions, we offer you purely tools! We are focused on developing and manufacturing innovative products using the best materials: high grade PP for structural parts, POM for the moving parts, filled techno polymers for the components that require greater resistance.



**100%
MADE
IN ITALY**

Thousand are the companies that work within the plastic district where TWT was born. TWT operates with the technology, the passion, the expertise and network of one of the most important Italian industrial districts.

**100%
FIRST
CHOICE**

100% high grade plastic. Thirty years of experience in product development and thermoplastics moulding have taught that the mechanical and chemical resistance suitable for professional use is guaranteed. High quality polypropylene for the surfaces of buckets and tools, POM for moving parts and gears, techno polymers with glass fibres in the sections subjected to greater stress.

**0 KM
100%
ECOLOGICAL**

TWT minimizes the ecological impact of the product life cycle. From design to production, from transport to use, up to disposal and recycling. Our starting point are the quality of the finish close to our production site, in order to reduce pollution generated by transport.

OUR TECHNOLOGY

TWT technology and design are at the service of performance. Each product is designed with particular attention to ergonomics and easy-working. The selection of first choice materials with the technical design make the difference in the word of cleaning!

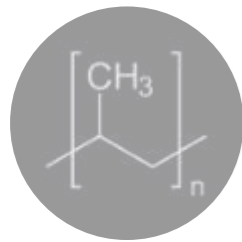

Polypropylene copolymer is a thermoplastic elastomer with better mechanical characteristics than the more commonly used Polypropylene monomer.

Polypropylene Copolymer

This material is used to produce all our buckets, the surfaces of the Giotto trolley, Duetto body and Prexa.

The PP copolymer is more resistant, melts at a higher temperature, moreover possesses high resistance against the chemical agents: it retains its strength characteristics in the presence of aqueous solutions containing salts, acids and strong alkalis. We use only non-recycled PP with great flexibility and strength that provides excellent shock-proof performance both on high and low temperatures.



POM Acetal Resin

POM: This is a semi-crystalline copolymer of great mechanical characteristics.

It is characterized by a series of properties that place it, as an alternative solution to substitute some metals such as steel, brass, aluminium in many mechanical components. Null water absorption, great dimensional precision and mechanical stability. It is suggested and use whenever strength and tight tolerances are required.

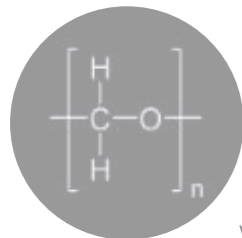

Using the first choice POM, TWT maximizes hardness, stability and the wear resistance.



OUR SYSTEM

TWT offers 100% Made in Italy tools and technologies, with a modern and extremely functional design, thus responding to current product standards in terms of ergonomics, resistance, efficiency and attention to the environment: from washing trolleys to service trolleys, from industrial mops to flat mops.

Materials

In addition to excellence in design and engineering, the quality of the materials makes the difference in terms of product reliability and durability. The main material that constitutes the Opera trolleys is copolymer polypropylene: it is a thermoplastic elastomer with better mechanical characteristics than the more commonly used Polypropylene monomer. It is more resistant and it has higher resistance to chemical agents, it melts at higher temperatures and has excellent shock-proof performance both on high and low temperatures.

Our environmental policies

The raw materials we use come from non-renewable sources. Therefore, we apply efficient and advantageous solutions, both on economic and on ecological point of view. The Polypropylene component, in most of our products, is perfectly recyclable.

Our highly integrated production chain reduces the incidence on environmental pollution by minimizing the emission of harmful gases due to road transport.

Certified Quality

TWT is **ISO 9001:2015** certified. This means that our quality system concerns all our management processes and the organization we implement to serve the market.

TWT srl is **ISO 14001:2015** certified. This confirms that the organization and the management system are adequate to keep the environmental impacts of the different company activities under control and systematically oriented to the improvement of environmental performances in an effective and sustainable way.



Composite plastic

Our strong competence and experience in techno polymer technology allows us to develop particular composite materials when a target approach is needed to satisfy specific technical needs with innovative solutions: this is the case of the Prexa torsion shaft, of which its mechanical and chemical resistance; another example is the structure of Plano for which a particular formulation in ABS has been developed that highlights its characteristics of lightness, rigidity and impact resistance.

ReUse LINE

The TWT range in recycled plastic materials: respects the environment, maintains elegance and design.



OPERA ReUse

GIOTTO Top Bin ReUse

Market trends and behaviour of public and private organizations are increasingly oriented towards green solutions, eco-sustainability and the use of recycled materials.

- ReUse line: over 90% of the plastic is recycled. A figure well above the competitors and the minimum required by national law (Italy) which requires at least 50% to obtain the certification of "recycled plastic" required by public tenders.
- The other materials in our products are mainly recyclable metals, this means that almost 100% of the materials that make up the TWT ReUse range are recyclable.

- Solid**
- Manoeuvrable**
- Easy to clean**
- Silent**
- Compact**

Certification

- Environmental declarations according to UNI EN ISO 10021: 2016, required by the CAM (minimum environmental criteria) for public sector purchases.
- The entire production process is monitored and verified by the competent authorities.

High performance

- Greater amount of recycled plastic (90%): percentage higher than competitors.
- More robust and reliable products: the structure of the OPERA trolley consists of more structured base, double-layer panels and doors, resistant brackets in aluminium.
- Recycled does not mean less reliable!



The dark colour is required to obtain smooth finish surfaces and good aesthetic results when the polypropylene used is recycled.

Our ReUse line associates the black colour with the aluminium finishes, grey or red. The aesthetic effect is very impactful and always guaranteed!
An elegant product that fits everywhere: from hotels to airports where the image is important and the product is often visible to guests.



COVID SECTION

- 12 SOLAR SYSTEM
pre-impregnation system
- 18 HYGIENE TOWER
disinfection station
- 19 MASK3000 disposable face masks IIR – CE certified



FLAT MOPPING SYSTEMS

- 60 PLANO cleaning floors
- 64 VOLO cleaning and dusting floors
- 71 MOP SYSTEM cleaning floors
- 76 AMBO / NEMO cleaning bucket
- 78 SURF squeegee
- 80 BROOMS and DUSTBINS
- 81 DUSTING
- 82 HANDLES



MOPPING TROLLEYS

- 20 GIOTTO
- 30 GIOTTO components
- 33 GIOTTO ReUse recycled plastic C.A.M certified
- 43 GIOTTO ReUse components
- 46 DUETTO
- 49 DUETTO components
- 50 PREXA wringer
- 53 PREXA components



MULTIPURPOSE TROLLEYS

- 83 OPERA service and cleaning trolley
- 88 SPEED motorized system for OPERA and OPERA ReUse
- 137 OPERA components
- 145 OPERA ReUse recycled plastic C.A.M certified
- 192 OPERA ReUse components
- 200 X TROLLEY
- 203 MULTI BIN TROLLEY
- 205 WASTE BINS

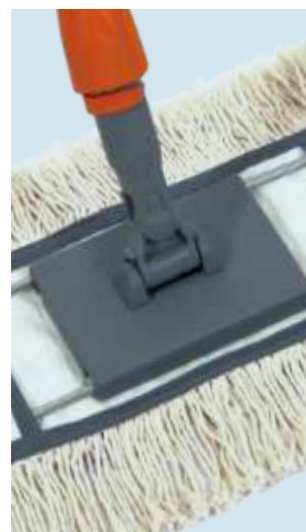

DUSTING SYSTEMS

- 56 DUST MOPS
 - 58 V-SWEEPERS
- Also:
- 80 BROOMS AND DUSTBINS
 - 81 DUSTING
 - 82 HANDLES



WINDOW CLEANING AND DISPENSER

- 206 SQUEEGEES, POLES AND ACCESSORIES
- 212 ETTORE BRASS SQUEEGEES
- 213 CLOTHS AND SPONGES
- 214 DISPENSER

- 218 Sales terms and conditions
- 219 Quality assurance certificate

SOLAR SYSTEM

GREEN TECHNOLOGY

The new instant impregnation system, digitally programmable.



Disinfection of floors and surfaces thanks to the spray lance.

Solar System is GREEN, environmentally friendly: Easy for anyone, powered by solar panels, scheduled in the use of the detergent, thus, reducing the consumption of water, chemicals and energy.



Detergent saving.

The cleaning solution is released with a touch thanks to the dispensing pump in the cart. The dose to be delivered is programmable using a specific software or through the integrated panel.

- The quantity of solution dispensed is scheduled with precision according to the specific characteristics of the mop replacement and floor.
- Only the filament, in contact with the floor, is impregnated. This allows to reduce the normal quantity of solution foreseen by the traditional impregnation systems.
- Solar System allows to impregnate only the replacements actually to be used in the daily service, thus avoiding the reconditioning of replacements that are not used. This could not be done using the common system of pre-impregnation.



Time and energy saving.

The pump is powered by a 12 Volt battery that is also supported for 30% by two solar panels. This mechanism allows you to take advantage of the natural or artificial light present in the rooms, guaranteeing product autonomy up to 1600 sprays. The battery is rechargeable by connecting the charger to an easily external connection.

- Solar System reduces the time of mop replacements' preparation.
- The presence of solar panels permits to increase the autonomy of the trolley, reducing the charging times and energy consumption.



Technological innovation ecological evolution.

Better hygiene

- Floors are always cleaned with uncontaminated mops. The system is designed to prevent dirty water be moved between different environments or departments.
- The detergent or disinfectant is dispensed immediately before use, in order to maintain its properties unaltered.

Better efficiency

- Solar System does not foresee the pre-impregnation of the mops to be used, as the impregnation is instant.
- It is possible to hook directly the mop and to place it in the tray containing the solution, without touching the mop.



GREEN, environmentally friendly.

- Allows a 50% reduction in the consumption of water, detergents and electricity.
- It is combined with TWT ReUse trolleys made of plastic CAM certified recycled.



1/2/3 programmable
dispensing pumps.



In the dedicated compartment, it is possible to place **up to 3 tanks of 5 litres of detergent** or disinfectant solution.



TWT Custom - the **programmable electronic control unit able to manage and control up to 3 dispensing pumps:**

A pump, can be used for the disinfectant's nebulization using the special spray lance or spray gun. The control unit optimizes the management of solar charging and the monitoring functions thanks to the download of data on use and consumption.





Optional: Spray lance or spray gun

Solar System functionality can be improved, equipping it with a spray lance or gun for the nebulization of disinfectant solutions on the surfaces as required by the Sanitation Protocol.



Solar System is available also with 120L or 2x70L bag support and 7 L buckets for cloth impregnation.

Description			
CODE	OP3500EN.SS1	OP3500EN.SS2	OP3500EN.SS3
			
MODEL	Solar System Trolley COMPACT 1.0	Solar System Trolley COMPACT 2.0	Solar System Trolley COMPACT 3.0
PRODUCT DIMENSIONS	750x630xh 1150 mm	750x630xh 1150 mm	750x630xh 1150 mm
PUMPS	1 1 pump for solution 1	2 1 pump for solution 1 1 pump for lance	3 1 pump for solution 1 1 pump for solution 2 1 pump for lance
DISINFECTION LANCE	Not included	Included	Included
DISPENSING PROGRAMMS	80ml 100 ml 150 ml 200 ml 250 ml 300 ml	80ml 100 ml 150 ml 200 ml 250 ml disinfection lance ♦	80ml 100 ml 150 ml 100 ml 150 ml disinfection lance ♦ Solut. 1 * Solut. 2 **

❖ The programs are pre-set, however you can change them as needed.
Change of programs must only be carried out by qualified personnel or it can be agreed with TWT, in advance.

CODE	OP1140EN.SS1	OP1140EN.S25	OP1140EN.SS2
			
MODEL	Solar System Trolley 1.0	Solar System Trolley 2.0	Solar System Trolley 2.1
PRODUCT DIMENSIONS	1100x630xh 1150 mm	1100x630xh 1150 mm	1100x630xh 1150 mm
PUMPS	1 1 pump for solution 1	2 1 pump for solution 1 1 pump for solution 2	2 1 pump for solution 1 1 pump for lance
DISINFECTION LANCE	Not included	Not included	Included
DISPENSING PROGRAMMS	80ml 100 ml 150 ml 200 ml 250 ml 300 ml	80ml 100 ml 150 ml 80 ml 100 ml 150 ml Solut. 1 * Solut. 2 **	80ml 100 ml 150 ml 200 ml 250 ml disinfection lance ♦ Impregnated cloth Solut. 1

♦ Available with lance or gun * Recommended for common areas ** Recommended for high-risk areas



Description

HYGIEN TOWER

Disinfection station made of bi-laminated multilayer wood.

It is equipped with a compartment for:

- surgical disposable face mask
- hand sanitizer
- paper towels
- disposable gloves
- trash bin

Code	pcs
WHITE HYGIEN.W	1
BLACK HYGIEN.B	1

Product dimensions	400x410x1450 mm
Packaging dimensions	400x400x1200h mm
Volume	0,19mc
Weight	9,0 kg

The disposable surgical mask of TWT srl is an high quality medical device, used in protocols to reduce the risk of spreading infections in particular during the current COVID19 emergency. MASK3000 is a Class I, Type IIR Medical Device (Reg. Ministry of Health 1990524). It complies with the technical standards UNI EN 14683: 2019 UNI EN ISO 10993-1: 2010 UNI EN 14971: 2012 UNI EN 1041: 2009 UNI EN ISO 15223-1: 2012 and therefore meets all the requirements of efficacy and safety.





Description

DISPOSABLE FACE MASK

MASK3000 is anatomical and adaptable to any shape or size of the face. It is equipped with two comfortable ear elastics and a practical, easily mouldable nose pad, which guarantee maximum safety, adherence and practicality.

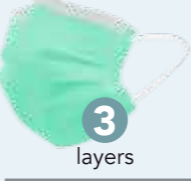
- Layers: 3 (internal/external: SPUN BOND intermediate: MELT BLOWN)
- Material: TNT 100%
- Bacterial filtration efficiency (BFE%) ≥ 98%
- Differential pressure (Pa/cm²): <60
- Microbial cleanliness (ufc/g): ≤30
- Splash resistance pressure (kPa): ≥16

2 surgical masks per poly bags

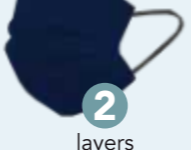
WHITE 3 layers	Poly bag		3 layers
	WHITE box		
	GRAPHIC box		
GREEN 3 layers	Poly bag		3 layers
	WHITE box		
	GRAPHIC box		
LIGHT BLUE 3 layers	Poly bag		3 layers
	WHITE box		
	GRAPHIC box		
LIGHT BLUE 2 layers	Poly bag		2 layers
	WHITE box		
	GRAPHIC box		
BLACK 3 layers	Poly bag		3 layers
	WHITE box		
	GRAPHIC box		
BLUE 2 layers	Poly bag		2 layers
	WHITE box		
	GRAPHIC box		

Shipping box with 250 loose polybas



Total 500 pcs

Mask-3 box with 25 polybags



Total 50 pcs

Shipping box with 10 Mask-3 boxes of 25 polybags each

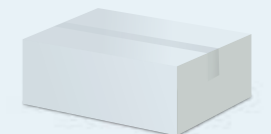

Total 500 pcs

MASK3500.W

MASK3050.WB

MASK3550.WB

MASK3050.WP

MASK3550.WP

MASK3500.G

MASK3050.GB

MASK3550.GB

MASK3050.GP

MASK3550.GP

MASK3500.B

MASK3050.BB

MASK3550.BB

MASK3050.BP

MASK3550.BP

MASK2500.B

MASK2050.BB

MASK2550.BB

MASK2050.BP

MASK2550.BP

MASK3500.BK

MASK3050.BKB

MASK3550.BKB

MASK3050.BKP

MASK3550.BKP

MASK2500.BN

MASK2050.BNB

MASK2550.BNB

MASK2050.BNP

MASK2550.BNP

GIOTTO

MOPPING TROLLEY



-  **Solid**
-  **Manoeuvrable**
-  **Easy to clean**
-  **Versatile**
-  **Silent**
-  **Compact**

Giotto is a mopping trolley used for small and big floors. It is built with first choice materials treated with EASY&CLEAN mode which permits less adhesion of liquids and dirty on its surface. The techno-polymer wheels, developed in TWT, ensure great manoeuvrability and noise-free. Different versions are available thanks also to the innovative configuration of accessories.



GIOTTO / DUETTO
GIOTTO ReUse



WHEEL

SILENT WHEEL is the newly designed wheel in bi-component techno polymer that guarantees maximum manoeuvrability and silence during use. Made in Italy, designed and created by TWT.



PREXA

Excellent solidity: innovative technical design of the structure; selection of the best quality plastic material, not recycled. Maximum resistance and reliability.



STRUCTURE





Better cleanability and hygiene: surfaces of structure and buckets are treated with Easy & Clean mode which guarantees less adhesion of liquids, dirt and facilitates its washing.

GIOTTO PRE-IMPREGNATION



TWT solution for small areas: GIOTTO PRE-IMPREGNATION

The new TWT pre-impregnation system for manual washing of floors and small surfaces. Effective, fast and safe. Ideal for professional cleaning, it guarantees high performance. A practical system, easy to use, economical and characterized by a remarkable flexibility of the system.

-  **Safe:** made with the same components as the Giotto range
-  **Practical:** easy to use and small
-  **Versatile and scalable:** the components for the configurations are available from stock
-  **Economical:** based on GIOTTO washing trolleys and not on the structure of the OPERA



S02002T4

Components included in the standard configuration

Base for Giotto 50 L with 80mm Silent wheels in plastic and 90mm bumpers	S0201300	1
Top Bin handle in grey painted metal with bag holder	S02016T1	1
FixT universal handle holder, for tubular Ø20 mm	C0202400	1
Swivel 7L bucket support in grey painted metal for Giotto Top Bin - left	C01214VR	1
Swivel 7L bucket support in grey painted metal for Giotto Top Bin - right	C01215VR	1
7L bucket in PP - blue handle	OPK0013B	1
7L bucket in PP - orange handle	OPK0013A	1
Tray in PP 50x19xh16 cm	OPA00700	1
Tray support 16x48 cm	S0100900S	1
20L drawer in PP 45x29xh16 cm	OPA00770	1

code	pcs
S0201300	1
S02016T1	1
C0202400	1
C01214VR	1
C01215VR	1
OPK0013B	1
OPK0013A	1
OPA00700	1
S0100900S	1
OPA00770	1

OPTIONAL

Pre-impregnation lid in PP 32x49cm for drawers 20L and 40L	OPA0201	1
Lid in PP for tray 50x19xh16 cm	OPA0204	1
Pre-impregnation lid in PP 16x30cm for bucket 7L	OPA0203	1
Plasticized bag, 90L, with zip and lid - grey	C0200600	1

code	pcs
OPA0201	1
OPA0204	1
OPA0203	1
C0200600	1

Product dimensions 920x790x1020 mm

Weight 12 kg

Packaging 730x460xh550 mm Volume 0,185 mc

GIOTTO PRE-IMPREGNATION

TWT solution for high performance professional cleaning.

Ideal for facilities with a limited number of rooms to be cleaned daily: **BARS, RESTAURANTS, OFFICES, SHOPS, HOTELS** of small and medium sizes.



Possible configurations

COMPONENTS PRE-IMPREGNATION TROLLEY



7L bucket in PP

OPK0013B

blue handle

OPK0013A

orange handle

OPK0013Y

yellow handle



Swivel 7L bucket support in grey painted metal for Giotto Top Bin

C01214VR

left

C01215VR

right



Pre-impregnation lid in PP 16x30cm for bucket 7L

OPA0203



Pre-impregnation grid in PP 16x30cm for bucket 7L

OPA0202



Tray in PP 31x22x12 cm

S0202001

orange handles

S0202001B

blue handles

S0202001R

red handles

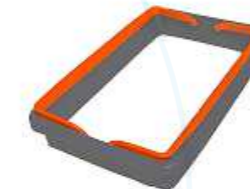

Waste bag holder in PP 70L 31x22cm

S0202002

orange handles

S0202002R

red handles

S0202002B

blue handles



Hooking clips kit for tray and 70L waste bag (4pcs) for central handle

S0202003



Swivel tray support in grey painted metal for Giotto Top Bin

C01114VR

left

C01115VR

right



Pre-impregnation lid in PP 32x49cm for drawers 20L and 40L

OPA0201



Pre-impregnation grid in PP 32x49cm for drawers 20L and 40L

OPA0200



Lid in PP for tray 50x19x16 cm

OPA0204



Central pushing handle in grey painted metal

S0201601



Plasticized bag, 90L, for Giotto Top Bin with zip and lid - grey

C0200600



Description	code	pcs
GIOTTO 50L base 50L, 2 buckets 25L in PP, Prexa wringer, ø80 mm Silent wheels in plastic and ø90 mm bumpers. Without pushing handle.	S0200501	1
GIOTTO 30L base 50L, 2 buckets 15L in PP, Prexa wringer, ø80 mm Silent wheels in plastic and ø90mm bumpers. Without pushing handle.	S0200601	1

	Product dimensions	Weight	Packaging dimensions & Volume	
50 L	770x440x880 mm	8,0 kg	730x460x550 mm	0,185 mc
30 L	710x440x880 mm	7,7 kg	730x460x550 mm	0,185 mc



Description	code	pcs
GIOTTO 50L ML base 50L, 2 buckets 25L in PP, Prexa wringer, ø80 mm Silent wheels in plastic and ø90 mm bumpers. With lateral pushing handle	S0200301	1
GIOTTO 30L ML base 50L, 2 buckets 15L in PP, Prexa wringer, ø80 mm Silent wheels in plastic and ø90 mm bumpers. With lateral pushing handle.	S0200401	1

	Product dimensions	Weight	Packaging dimensions & Volume	
50L ML	770x440x880 mm	8,6 kg	730x460x550 mm	0,185 mc
30L ML	710x440x880 mm	8,3 kg	730x460x550 mm	0,185 mc



Description	code	pcs
GIOTTO 50L MC base 50L, 2 buckets 25L in PP, Prexa wringer, ø80 mm Silent wheels in plastic and ø90 mm bumpers. With central pushing handle	S0200101	1
GIOTTO 30L MC base 50L, 2 buckets 15L in PP, Prexa wringer, ø80 mm Silent wheels in plastic and ø90 mm bumpers. With central pushing handle	S0200201	1

	Product dimensions	Weight	Packaging dimensions & Volume	
50L MC	840x440x920 mm	9,2 kg	730x460x550 mm	0,185 mc
30L MC	820x440x920 mm	8,9 kg	730x460x550 mm	0,185 mc



Description	code	pcs
GIOTTO 25L base 25L, 1 bucket 25L in PP, Prexa wringer, ø80 mm Silent wheels in plastic and ø90 mm bumpers. Without pushing handle	S0201101	1
GIOTTO 15L base 25L, 1 bucket 15L in PP, Prexa wringer, ø80 mm Silent wheels in plastic and ø90 mm bumpers. Without pushing handle	S0201201	1

	Product dimensions	Weight	Packaging dimensions & Volume	
25 L	600x440x880 mm	6,9 kg	650x460x550 mm	0,164 mc
15 L	570x440x880 mm	6,8 kg	650x460x550 mm	0,164 mc



Description	code	pcs
GIOTTO 25L ML base 25L, 1 bucket 25L in PP, Prexa wringer, ø80 mm Silent wheels in plastic and ø90 mm bumpers. With lateral pushing handle	S0200901	1
GIOTTO 15L ML base 25L, 1 bucket 15L in PP, Prexa wringer, ø80 mm Silent wheels in plastic and ø90 mm bumpers. With lateral pushing handle	S0201001	1

	Product dimensions	Weight	Packaging dimensions & Volume	
25L ML	600x440x880 mm	7,5 kg	650x460x550 mm	0,164 mc
15L ML	570x440x880 mm	7,4 kg	650x460x550 mm	0,164 mc



Description	code	pcs
GIOTTO 25L MC base 25L, 1 bucket 25L in PP, Prexa wringer, ø80 mm Silent wheels in plastic, ø90 mm bumpers. With central pushing handle	S0200701	1
GIOTTO 15L MC base 25L, 1 bucket 15L in PP, Prexa wringer, ø80 mm Silent wheels in plastic, ø90 mm bumpers. With central pushing handle	S0200801	1

	Product dimensions	Weight	Packaging dimensions & Volume	
25L MC	800x440x920 mm	8,1 kg	650x460x550 mm	0,164 mc
15L MC	780x440x920 mm	7,9 kg	650x460x550 mm	0,164 mc



Description	code	pcs
GIOTTO 25L base 25L, 1 bucket 25L in PP, Prexa wringer, ø80 mm Silent wheels in plastic, ø90 mm bumpers. 1 tray in PP 31x22x12h cm with handles, 1 support for waste bag in PP 70L 31x22 cm with hooking clips. With central pushing handle	S0203101	1
GIOTTO 50L base 50L, 1 bucket 25L in PP, Prexa wringer, ø80 mm Silent wheels in plastic, ø90 mm bumpers. 1 tray in PP 31x22x12h cm with handles, 1 support for waste bag in PP 70L 31x22 cm with hooking clips. With central pushing handle	S0203201	1

	Product dimensions	Weight	Packaging dimensions & Volume	
25L	800x440x920 mm	8,9 kg	730x460x550 mm	0,185 mc
50L	800x440x920 mm	9,0 kg	730x460x550 mm	0,185 mc



Description	code	pcs
GIOTTO 15L + 10L base 50L, 1 double vat bucket 15L +10L in PP (dirty water, clean water), Prexa wringer, ø80 mm Silent wheels in plastic, ø90 mm bumpers. 1 tray in PP 31x22x12h cm with handles, 1 support for waste bag in PP 70L 31x22 cm with hooking clips. With central pushing handle	S020B30	1

	Product dimensions	Weight	Packaging dimensions & Volume	
15L + 10L	930x440x920 mm	10,0 kg	730x460x550 mm	0,185 mc



Description	code	pcs
GIOTTO TOP BIN 1 25L base 50L, 1 bucket 25L in PP, Prexa wringer, ø80 mm Silent wheels in plastic, ø90 mm bumpers. 1 tray in PP 31x22x12h cm with handles, 1 swivel support for tray. Central handle with 90L bag holder Optional: plasticized bag 90L	S02001T1	1

	Product dimensions	Weight	Packaging dimensions & Volume	
TOP BIN 1 25L	920x790x1020 mm	9,5 kg	730x460x550 mm	0,185 mc



Description	code	pcs
GIOTTO TOP BIN 2 25L base 50L, 1 bucket 25L in PP, Prexa wringer, ø80 mm Silent wheels in plastic, ø90 mm bumpers. 1 bucket 7L in PP 30x16xh23 cm, 1 swivel support for bucket. Central handle with 90L bag holder Optional: plasticized bag 90L	S02001T2	1

	Product dimensions	Weight	Packaging dimensions & Volume	
TOP BIN 2 25L	920x790x1020 mm	10,0 kg	730x460x550 mm	0,185 mc



Description	code	pcs
GIOTTO TOP BIN 3 25L base 50L, 1 bucket 25L in PP, Prexa wringer, ø80 mm Silent wheels in plastic, ø90 mm bumpers. 1 tray in PP 31x22x12h cm with handles, 1 swivel support for tray. 1 bucket 7L in PP 30x16xh23 cm and 1 swivel support for bucket. Central handle with 90L bag holder. Optional: plasticized bag 90L	S02001T3	1

	Product dimensions	Weight	Packaging dimensions & Volume	
TOP BIN 3 25L	920x790x1020 mm	10,5 kg	730x460x550 mm	0,185 mc



Description	code	pcs
GIOTTO TOP BIN 4 25L base 50L, 1 bucket 25L in PP, Prexa wringer, ø80 mm Silent wheels in plastic, ø90 mm bumpers. 2 buckets 7L in PP 30x16xh23 cm, 2 swivel supports for bucket. Central handle with 90L bag holder Optional: plasticized bag 90L	S02001T4	1

	Product dimensions	Weight	Packaging dimensions & Volume	
TOP BIN 4 25L	920x790x1020 mm	10,5 kg	730x460x550 mm	0,185 mc



Description	code	pcs
GIOTTO TOP BIN 1 15L + 10L base 50L, 1 double vat bucket 15L+10L in PP (dirty water, clean water), Prexa wringer, ø80 mm Silent wheels in plastic, ø90 mm bumpers. 1 tray in PP 31x22x12h cm with handles, 1 swivel support for tray. Central handle with 90L bag holder Optional: plasticized bag 90L	S020B10	1

	Product dimensions	Weight	Packaging dimensions & Volume	
TB1 15L + 10L	930x440x1020 mm	12,0 kg	730x460x550 mm	0,185 mc



Description	code	pcs
GIOTTO TOP BIN 4 15L + 10L base 50L, 1 double vat bucket 15L+10L in PP (dirty water, clean water), Prexa wringer, ø80 mm Silent wheels in plastic, ø90 mm bumpers. 2 buckets 7L in PP 30x16xh23 cm, 2 swivel supports for bucket. Central handle with 90L bag holder Optional: plasticized bag 90L	S020B40	1

	Product dimensions	Weight	Packaging dimensions & Volume	
TB4 15L + 10L	930x440x1020 mm	12,5 kg	730x460x550 mm	0,185 mc

Description	code	pcs
 Base for Giotto 50 L (DOUBLE BUCKET) with Ø 80mm Silent wheels in plastic and Ø 90mm bumpers	S0201300	1
 Base for Giotto 25 L (SINGLE BUCKET) with Ø 80mm Silent wheels in plastic and Ø 90mm bumpers	S0201301	1
 Wheel, metal, Ø 80mm	M0201RU2	1
 Silent Wheel, plastic, Ø 80mm	S020180G	1
 Bumper in PP, Ø90mm, grey	S0201901G	1
PREXA I down press wringer, POM wringing bars with rubber inserts		
Orange	S0100101	1
Red	S0100101R	1
Blue	S0100101B	1
PREXA S down press wringer, DELRIN wringing bars without rubber inserts		
Orange	S0100201	1
Red	S0100201R	1
Blue	S0100201B	1
ELPA press wringer	S0100222	1

Description	code	pcs
 25 L bucket in PP - grey		
orange handle	S0201401	1
red handle	S0201402	1
blue handle	S0201403	1
 15 L bucket in PP - grey		
orange handle	S0201501	1
red handle	S0201502	1
blue handle	S020150B	1
 15 L+10 L double vat bucket in PP - grey		
orange handle	S020160A	1
red handle	S020160R	1
blue handle	S020160B	1
 Tray in PP 31x22x12 cm without handles	S0202000	1
 Tray in PP 31x22x12 cm		
orange handles	S0202001	1
red handles	S0202001B	1
blue handles	S0202001R	1
 7L bucket in PP 30x16x23 cm		
orange handle	OPK0013A	1
blue handle	OPK0013B	1
green handle	OPK0013G	1
red handle	OPK0013R	1
yellow handle	OPK0013Y	1
 swivel tray support in grey painted metal for Giotto Top Bin		
left	C01114VR	1
right	C01115VR	1
 swivel 7L bucket support in grey painted metal for Giotto Top Bin		
left	C01214VR	1
right	C01215VR	1
 Waste bag holder in PP 70L 31x22cm		
orange handles	S0202002	1
blue handles	S0202002B	1
red handles	S0202002R	1
 Hooking clips kit for tray and 70L waste bag (4pcs) for central handle	S0202003	1
 Central pushing handle in grey painted metal	S0201601	1

Description	code	pcs
Lateral pushing handle in grey painted metal		
orange cap	S0201701	1
red cap	S0201701R	1
blue cap	S0201701B	1
Top Bin handle in grey painted metal with bag holder		
orange cap	S02016T1	1
red cap	S02016T1R	1
blue cap	S02016T1B	1
FixT universal handle holder, for tubular Ø 20mm	C0202400	1
Plasticized bag, 90L, for Giotto Top Bin with zip and lid - grey	C0200600	1
Plastic filling hose, 150 cm	SAD001	1
Safety sign in PP - Italian "Attenzione pavimento bagnato"	A0700100	5
Safety sign in PP - Francais "Attention sol glissant"	A0700100F	5
Safety sign in PP - English "Caution wet floor"	A0700100E	5
Safety sign in PP - Deutsch "Achtung rutschgefahr"	A0700100D	5
FLY open/close plastic dustbin with broom	AIS001A	6

GIOTTO ReUse

WASHING TROLLEY **RECYCLED** PLASTIC **C.A.M. CERTIFIED**







GIOTTO Re-Use PRE-IMPREGNATION



TWT solution for small areas: GIOTTO PRE-IMPREGNATION

The new TWT pre-impregnation system for manual washing of floors and small surfaces. Effective, fast and safe. Ideal for professional cleaning, it guarantees high performance. A practical system, easy to use, economical and characterized by a remarkable flexibility of the system.

-  **Safe:** made with the same components as the Giotto range
-  **Practical:** easy to use and small
-  **Versatile and scalable:** the components for the configurations are available from stock
-  **Economical:** based on GIOTTO washing trolleys and not on the structure of the OPERA



S02002T4ECN

Components included in the standard configuration

Base for Giotto ReUse 50 L with 80mm metal wheels and 90mm bumpers	S0201300ECN	1
Top Bin handle in grey painted metal with bag holder	S02016T1R	1
FixT universal handle holder, for tubular Ø20 mm	C0202400	1
Swivel 7L bucket support in grey painted metal for Giotto Top Bin - left	C01214VR	1
Swivel 7L bucket support in grey painted metal for Giotto Top Bin - right	C01215VR	1
7L bucket in PP - blue handle	OPK0013NB	1
7L bucket in PP - red handle	OPK0013NR	1
Tray in PP 50x19xh16 cm	OPA00700N	1
Tray support 16x48 cm	S0100900S	1
20L drawer in PP 45x29xh16 cm	OPA0077N	1

code	pcs
S0201300ECN	1
S02016T1R	1
C0202400	1
C01214VR	1
C01215VR	1
OPK0013NB	1
OPK0013NR	1
OPA00700N	1
S0100900S	1
OPA0077N	1

OPTIONAL

Pre-impregnation lid in PP 32x49cm for drawers 20L and 40L	OPA0201	1
Lid in PP for tray 50x19xh16 cm	OPA0204	1
Pre-impregnation lid in PP 16x30cm for bucket 7L	OPA0203	1
Plasticized bag, 90L, with zip and lid - grey	C0200600	1

code	pcs
OPA0201	1
OPA0204	1
OPA0203	1
C0200600	1

Product dimensions 920x790x1020 mm

Weight 12 kg

Packaging 730x460xh550 mm Volume 0,185 mc

GIOTTO Re-Use PRE-IMPREGNATION

TWT solution for
high performance professional cleaning.

Ideal for facilities
with a limited number
of rooms to be cleaned daily:
**BARS, RESTAURANTS,
OFFICES, SHOPS,
HOTELS**
of small and
medium sizes.



Possible configurations

COMPONENTS PRE-IMPREGNATION TROLLEY



7L bucket in PP ReUse
30x16xh23 cm

OPK0013NB
blue handle

OPK0013NR
red handle



Swivel 7L bucket support in grey
painted metal for Giotto Top Bin

C01214VR
left

C01215VR
right



Pre-impregnation lid in PP
16x30cm for bucket 7L

OPA0203



Pre-impregnation grid in PP
16x30cm for bucket 7L

OPA0202



Tray in PP ReUse
31x22xh12 cm

S0202001BN
blue handles

S0202001RN
red handles



Waste bag holder in PP 70L
31x22cm - black

S0202002RNX
red handles

S0202002BNX
blue handles



Hooking clips kit for tray and
70 L waste bag (4pcs) for
central handle

S0202003



Swivel tray support in grey
painted metal for Giotto Top Bin

C01114VR
left

C01115VR
right



Pre-impregnation lid in PP
32x49cm for drawers 20L and 40L

OPA0201



Pre-impregnation grid in PP
32x49cm for drawers 20L and 40L

OPA0200



Lid in PP for tray
50x19xh16 cm

OPA0204



Central pushing handle in grey
painted metal

S0201601



Plasticized bag, 90L, for Giotto
Top Bin with zip and lid - grey

C0200600



Description	code	pcs
GIOTTO R 50L base ReUse 50L, 2 buckets 25L in PP ReUse, black Prexa wringer, ø80 mm metal wheels and ø90 mm bumpers. Without pushing handle	S0200501ECN	1
GIOTTO R 30L base ReUse 50L, 2 buckets 15L in PP ReUse, black Prexa wringer, ø80 mm metal wheels and ø90 mm bumpers. Without pushing handle	S0200601ECN	1

	Product dimensions	Weight	Packaging dimensions & Volume	
50L	770x440x880 mm	8,0 kg	730x460x550 mm	0,185 mc
30L	710x440x880 mm	7,7 kg	730x460x550 mm	0,185 mc



Description	code	pcs
GIOTTO R 50L ML base ReUse 50L, 2 buckets 25L in PP ReUse, black Prexa wringer, ø80 mm metal wheels and ø90 mm bumpers. With lateral pushing handle	S0200301ECN	1
GIOTTO R 30L ML base ReUse 50L, 2 buckets 15L in PP ReUse, black Prexa wringer, ø80 mm metal wheels and ø90 mm bumpers. With lateral pushing handle	S0200401ECN	1

	Product dimensions	Weight	Packaging dimensions & Volume	
50L ML	770x440x880 mm	8,6 kg	730x460x550 mm	0,185 mc
30L ML	710x440x880 mm	8,3 kg	730x460x550 mm	0,185 mc



Description	code	pcs
GIOTTO R 50L MC base ReUse 50L, 2 buckets 25L in PP ReUse, black Prexa wringer, ø80 mm metal wheels and ø90 mm bumpers. With central pushing handle	S0200101ECN	1
GIOTTO R 30L MC base ReUse 50L, 2 buckets 15L in PP ReUse, black Prexa wringer, ø80 mm metal wheels and ø90 mm bumpers. With central pushing handle	S0200201ECN	1

	Product dimensions	Weight	Packaging dimensions & Volume	
50L MC	840x440x920 mm	9,2 kg	730x460x550 mm	0,185 mc
30L MC	820x440x920 mm	8,9 kg	730x460x550 mm	0,185 mc



Description	code	pcs
GIOTTO R 25L base ReUse 25L, 1 bucket 25L in PP ReUse, black Prexa wringer, ø80 mm metal wheels and ø90 mm bumpers. Without pushing handle	S0201101ECN	1
GIOTTO R 15L base ReUse 25L, 1 bucket 15L in PP ReUse, black Prexa wringer, ø80 mm metal wheels and ø90 mm bumpers. Without pushing handle	S0201201ECN	1

	Product dimensions	Weight	Packaging dimensions & Volume	
25L	600x440x880 mm	6,9 kg	650x460x550 mm	0,164 mc
15L	570x440x880 mm	6,8 kg	650x460x550 mm	0,164 mc



Description	code	pcs
GIOTTO R 25L ML base ReUse 25L, 1 bucket 25L in PP ReUse, black Prexa wringer, ø80 mm metal wheels and ø90 mm bumpers. With lateral pushing handle	S0200901ECN	1
GIOTTO R 15L ML base ReUse 25L, 1 bucket 15L in PP ReUse, black Prexa wringer, ø80 mm metal wheels and ø90 mm bumpers. With lateral pushing handle	S0201001ECN	1

	Product dimensions	Weight	Packaging dimensions & Volume	
25L ML	600x440x880 mm	7,5 kg	650x460x550 mm	0,164 mc
15L ML	570x440x880 mm	7,4 kg	650x460x550 mm	0,164 mc



Description	code	pcs
GIOTTO R 25L MC base ReUse 25L, 1 bucket 25L in PP ReUse, black Prexa wringer, ø80 mm metal wheels and ø90 mm bumpers. With central pushing handle	S0200701ECN	1
GIOTTO R 15L MC base ReUse 25L, 1 bucket 15L in PP ReUse, black Prexa wringer, ø80 mm metal wheels and ø90 mm bumpers. With central pushing handle	S0200801ECN	1

	Product dimensions	Weight	Packaging dimensions & Volume	
25L MC	800x440x920 mm	8,1 kg	650x460x550 mm	0,164 mc
15L MC	780x440x920 mm	7,9 kg	650x460x550 mm	0,164 mc



Description	code	pcs
GIOTTO R 25L base ReUse 25L, 1 bucket 25L in PP ReUse, black Prexa wringer, ø80 mm metal wheels and ø90 mm bumpers. 1 tray in PP ReUse 31x22x12h cm with handles, 1 black support for waste bag in PP 70L 31x22 cm with hooking clips. Central pushing handle	S0203101ECN	1
GIOTTO R 50L base ReUse 50L, 1 bucket 25L in PP ReUse, black Prexa wringer, ø80 mm metal wheels and ø90 mm bumpers. 1 tray in PP ReUse 31x22x12h cm with handles, 1 black support for waste bag in PP 70L 31x22 cm with hooking clips. Central pushing handle	S0203201ECN	1

	Product dimensions	Weight	Packaging dimensions & Volume	
25L	800x440x920 mm	8,9 kg	730x460x550 mm	0,185 mc
50L	800x440x920 mm	9,0 kg	730x460x550 mm	0,185 mc



Description	code	pcs
GIOTTO R 15L + 10L base ReUse 50L, 1 black double vat bucket 15L +10L in PP (dirty water, clean water), black Prexa wringer, ø80 mm metal wheels and ø90 mm bumpers. 1 tray in PP ReUse 31x22x12h cm with handles, 1 black support for waste bag in PP 70L 31x22 cm with hooking clips. Central pushing handle	S020B30EN	1

	Product dimensions	Weight	Packaging dimensions & Volume	
15L + 10L	930x440x920 mm	10,0 kg	730x460x550 mm	0,185 mc



Description	code	pcs
GIOTTO R TOP BIN 1 25L base ReUse 50L, 1 bucket 25L in PP ReUse, black Prexa wringer, ø80 mm metal wheels and ø90 mm bumpers. 1 tray in PP ReUse 31x22x12h cm with handles, 1 swivel support for tray. Central handle with 90L bag holder. Optional: plasticized bag 90L	S02001T1ECN	1

	Product dimensions	Weight	Packaging dimensions & Volume	
TOP BIN 1 25L	920x790x1020 mm	9,0 kg	730x460x550 mm	0,185 mc



Description	code	pcs
GIOTTO R TOP BIN 2 25L base ReUse 50L, 1 bucket 25L in PP ReUse, black Prexa wringer, ø80 mm metal wheels and ø90 mm bumpers. 1 bucket 7L in PP ReUse 30x16xh23 cm, 1 swivel support for bucket. Central handle with 90L bag holder. Optional: plasticized bag 90L	S02001T2ECN	1

	Product dimensions	Weight	Packaging dimensions & Volume	
TOP BIN 2 25L	920x790x1020 mm	10,0 kg	730x460x550 mm	0,185 mc



Description	code	pcs
GIOTTO R TOP BIN 3 25L base ReUse 50L, 1 bucket 25L in PP ReUse, black Prexa wringer, ø80 mm metal wheels and ø90 mm bumpers. 1 tray in PP ReUse 31x22x12h cm with handles, 1 swivel support for tray, 1 bucket 7L in PP ReUse 30x16xh23 cm, 1 swivel support for bucket. Central handle with 90L bag holder. Optional: plasticized bag 90L	S02001T3ECN	1

	Product dimensions	Weight	Packaging dimensions & Volume	
TOP BIN 3 25L	920x790x1020 mm	10,0 kg	730x460x550 mm	0,185 mc



Description	code	pcs
GIOTTO R TOP BIN 4 25L base ReUse 50L, 1 bucket 25L in PP ReUse, black Prexa wringer, ø80 mm metal wheels and ø90 mm bumpers. 2 buckets 7L in PP ReUse 30x16xh23 cm, 2 swivel supports for bucket. Central handle with 90L bag holder. Optional: plasticized bag 90L	S02001T4ECN	1

	Product dimensions	Weight	Packaging dimensions & Volume	
TOP BIN 4 25L	920x790x1020 mm	10,0 kg	730x460x550 mm	0,185 mc



Description	code	pcs
GIOTTO R TOP BIN 1 15L + 10L base ReUse 50L, 1 black double vat bucket 15L+10L in PP (dirty water, clean water), black Prexa wringer, ø80 mm metal wheels and ø90 mm bumpers. 1 tray in PP ReUse 31x22x12h cm with handles, 1 swivel support for tray. Central handle with 90L bag holder. Optional: plasticized bag 90L	S020B10EN	1

	Product dimensions	Weight	Packaging dimensions & Volume	
TOP BIN 1 15L + 10L	920x440x1020 mm	11,0 kg	730x460x550 mm	0,185 mc











Description	code	pcs
GIOTTO R TOP BIN 4 15L + 10L base ReUse LT 50, 1 black double vat bucket 15lt +10lt in PP (dirty water, clean water), black Prexa wringer, Ø 80mm metal wheels and ø90 mm bumpers. 2 buckets 7L in PP ReUse 30x16xh23 cm, 2 swivel supports for bucket. Central handle with 90L bag holder. Optional: plasticized bag 90L	S020B40EN	1









	Product dimensions	Weight	Packaging dimensions & Volume	
TOP BIN 4 15L + 10L	920x440x1020 mm	11,8 kg	730x460x550 mm	0,185 mc



GIOTTO ReUse COMPONENTS

Description	code	pcs
 <p>Base for Giotto ReUse 50 L (DOUBLE BUCKET) with Ø 80mm metal wheels and Ø 90mm bumpers</p>	S0201300ECN	1
 <p>Base for Giotto ReUse 25 L (SINGLE BUCKET) with Ø 80mm metal wheels and Ø 90mm bumpers</p>	S0201301ECN	1
 <p>Wheel, metal, Ø 80mm</p>	M0201RU2	1
 <p>Silent Wheel, plastic, Ø 80mm</p>	S020180G	1
 <p>Bumper in PP, Ø90mm, grey</p>	S0201901G	1
 <p>25L bucket in PP ReUse</p>		
<p>red handle</p>	S0201402N	1
<p>blue handle</p>	S0201403N	1
 <p>15L bucket in PP ReUse</p>		
<p>red handle</p>	S0201502N	1
<p>blue handle</p>	S0201503N	1
 <p>15 L+10 L double vat bucket in PP- black</p>		
<p>red handle</p>	S020160RNX	1
<p>blue handle</p>	S020160BNX	1

Description	code	pcs
 PREXA I down press wringer, POM wringing bars with rubber inserts	S0100101NX	1
 PREXA S down press wringer, DELRIN wringing bars without rubber inserts	S0100201NR	1
 ELPA press wringer	S0100222	1
7L bucket in PP ReUse 30x16xh23 cm		
blue handle	OPK0013NB	1
green handle	OPK0013NG	1
red handle	OPK0013NR	1
yellow handle	OPK0013NY	1
 Tray in PP ReUse 31x22xh12 cm without handles	S020200N	1
 Tray in PP ReUse 31x22xh12 cm		
red handles	S0202001RN	1
blue handles	S0202001BN	1
 Waste bag holder in PP 70L 31x22cm - black		
red handles	S0202002RNX	1
blue handles	S0202002BNX	1
 Hooking clips kit for tray and 70 L waste bag (4pcs) for central handle	S0202003	1
swivel tray support in grey painted metal for Giotto Top Bin		
left	C01114VR	1
right	C01115VR	1
swivel 7L bucket support in grey painted metal for Giotto Top Bin		
left	C01214VR	1
right	C01215VR	1

Description	code	pcs
 Central pushing handle in grey painted metal	S0201601	1
 Lateral pushing handle in grey painted metal		
red cap	S0201701R	1
blue cap	S0201701B	1
 Top Bin handle in grey painted metal with bag holder		
red cap	S02016T1R	1
blue cap	S02016T1B	1
 FixT universal handle holder for tubular Ø 20mm	C0202400	1
 Plasticized bag, 90L, for Giotto Top Bin with zip and lid - grey	C0200600	1
 Plastic filling hose 150 cm	SAD001	1
 Safety sign in PP - Italian "Attenzione pavimento bagnato"	A0700100	5
Safety sign in PP - French "Attention sol glissant"	A0700100F	5
Safety sign in PP - English "Caution wet floor"	A0700100E	5
Safety sign in PP - German "Achtung rutschgefahr"	A0700100D	5
 FLY open/close plastic dustbin with broom	AIS001A	6



DUETTO

WASHING TROLLEY



High performances:
 the largest in its category, 40L of total capacity. With the wringer installed, 15L of clean detergent solution and 15L effective for the dirty water. The larger dimensions facilitate the correct washing cycle in 3 phases:
 1) soaking and squeezing clean mop
 2) washing
 3) rinsing and squeezing dirty mop



QuickOut:
 Quick-connect double drain plug system for faster and safer emptying of water (clean / dirty).



Better hygiene:
 the Duetto bucket is treated with Easy Clean mode to facilitate washing.

-  **Solid**
-  **Manoeuvrable**
-  **Easy to clean**
-  **Versatile**
-  **Silent**
-  **Compact**





Description	code	pcs
DUETTO with drain plugs and central handle 16L+ 24L double vat bucket in PP with Ø80mm Silent Wheel in plastic, Ø90mm bumpers and Prexa wringer	S0300101	1
DUETTO without drain plugs and with central handle 16L+ 24L double vat bucket in PP with Ø80mm Silent Wheel in plastic, Ø90mm bumpers and Prexa wringer	S0300201	1

	Product dimensions	Weight	Packaging dimensions & Volume
DUETTO	740x320x900 mm	6,9 kg	630x370x550 mm 0,205 mc



Description	code	pcs
DUETTO with drain plugs and without central handle 16L+ 24L double vat bucket in PP with Ø80mm Silent Wheel in plastic, Ø90mm bumpers and Prexa wringer	S0300301	1
DUETTO without drain plugs and central handle 16L + 24L double vat bucket in PP with Ø80mm Silent Wheel in plastic, Ø90mm bumpers and Prexa wringer	S0300401	1

	Product dimensions	Weight	Packaging dimensions & Volume
DUETTO	740x320x880 mm	6,0 kg	630x370x550 mm 0,205 mc



Description	code	pcs
PREXA I down press wringer, POM wringing bars, version with rubber inserts		
orange splash guards	S0100101	5
red splash guards	S010010R	5
blue splash guards	S010010B	5
PREXA S down press wringer with press bar in Delrin without rubber inserts		
orange splash guards	S0100201	5
red splash guards	S010020R	5
blue splash guards	S010020B	5



Description	code	pcs
16L+24L double vat bucket in PP with 2 QuickOut plugs and orange handles	S0300501	1
16L+24L double vat bucket in PP with orange handles - without Quick-Out plug	S0300701	1
Silent Wheel, plastic, Ø 80mm	S020180G	1
Bumper Ø90mm in PP, grey	S0201901G	1
"Quick Out"; Easy connection drain plug	S0300601	1
Central pushing handle in grey painted metal	S0300801	1
Filling hose in plastic 150 cm	SAD001	1



PREXA

WRINGER

PREXA, down press wringer can be used on all TWT mopping trolleys and it is compatible with all similar trolleys of the major players on the market.

Prexa is available in 2 versions:

Prexa I – down press wringer, POM wringing bars, version with rubber inserts

Prexa S – down press wringer with press bar in Delrin without rubber inserts

-  **Ergonomic**
-  **Universal**
-  **Solid**

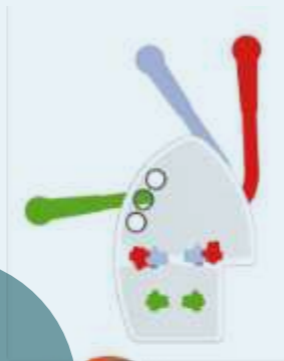

PREXA

WRINGER



Better **ergonomics**, thanks to the efficiency of the mechanical lever.



Universal wringer: the innovative press bars with integrated rubber inserts make Prexa (Prexa I version) the real universal wringer. It can easily wring Kentucky mops as well as any type of flat mops.



Great endurance: Techno polymers filled with fiberglass, first choice PP and Delrin. Advanced technical design, moulding and mechanical processing strictly Made in Italy, make Prexa a champion of resistance.



Rubber inserts PREXA I

PREXA on Duetto and Giotto











Description	code	pcs
PREXA I down press wringer, POM wringing bars, version with rubber inserts		
orange splash guards	S0100101	5
red splash guards	S010010R	5
blue splash guards	S010010B	5
PREXA S down press wringer with press bar in Delrin without rubber inserts		
orange splash guards	S0100201	5
red splash guards	S010020R	5
blue splash guards	S010020B	5

PREXA COMPONENTS



Description	code	pcs
Prexa body in PP	S0100300	1
Right splash guards in PP, screws included - orange	S0100401	1
Right splash guards in PP, screws included - red	S0100401R	1
Right splash guards in PP, screws included - blue	S0100401B	1
Left splash guards in PP, screws included - orange	S0100501	1
Left splash guards in PP, screws included - red	S0100501R	1
Left splash guards in PP, screws included - blue	S0100501B	1

	Description	code	pcs
	One pressure bar in Delrin without rubber insert - for PREXA S	S0100600	1
	One pressure bar in Delrin with rubber insert - for PREXA I	S0100700	1
	Right set of gears in Delrin	S0100800	1
	Left set of gears in Delrin	S0100900	1
	Handle holder for wringer	S0100303	1
	Handle support	S0100801	1
	Handle with ergonomic grip - orange cap	S0101200	1
	Handle with ergonomic grip - red cap	S0101200R	1
	Handle with ergonomic grip - blue cap	S0101200B	1
	Traction spring	S0101000	1
	8 screws for splash guard	M0101100	8

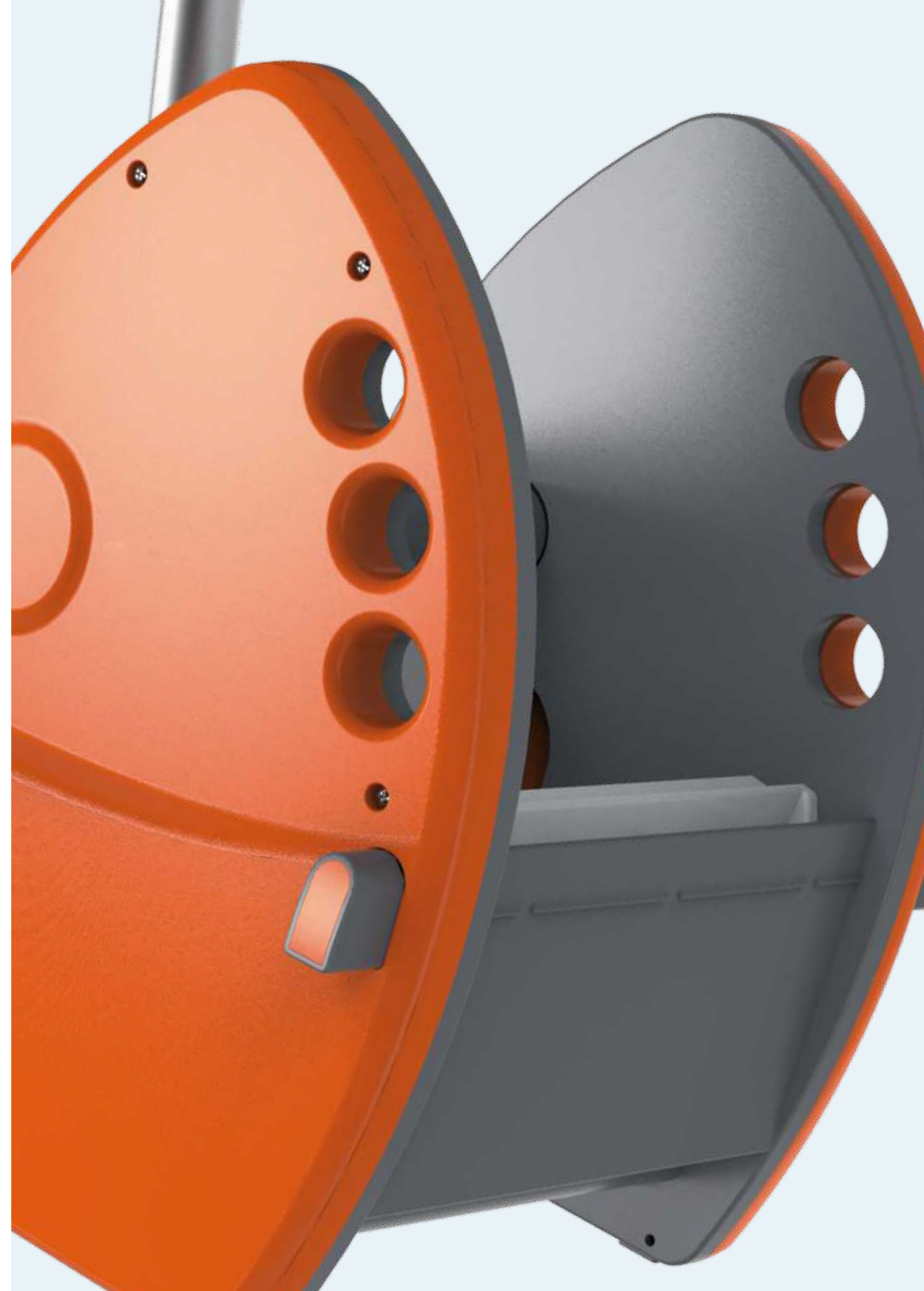

DUST MOPS

AND FRAMES

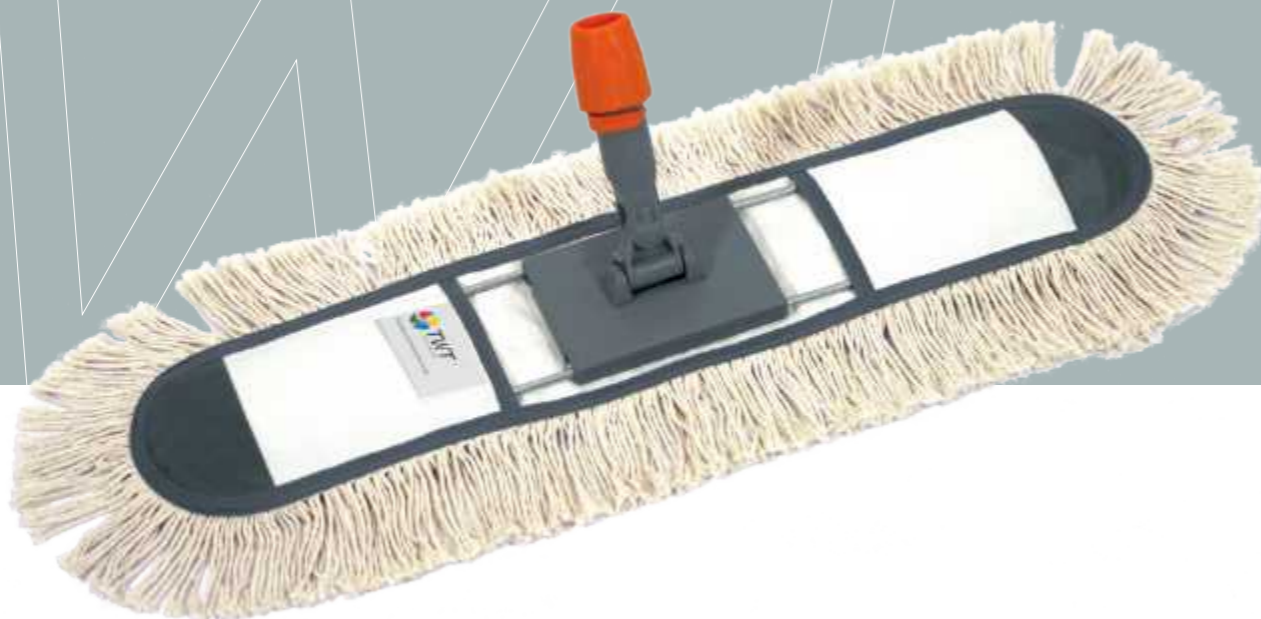

Description	code	pcs
DUST MOP SWEEPER SUPER SOFT 65% PLS 35% cotton, non-shrink support 100% PLS, complete with frame, without handle		
Dust mop cm 40	A0402101	15
Dust mop cm 60	A0402201	15
Dust mop cm 80	A0402301	15
Dust mop cm 100	A0402401	15

DUST MOPS REPLACEMENTS AND FRAMES

Description	code	pcs
 Metal frame cm 40	A0400101	25
 Metal frame cm 60	A0400102	25
 Metal frame cm 80	A0400103	25
 Metal frame with double arch cm 100	A0400104	25
DUST MOP REPLACEMENT SUPER SOFT 65% PLS 35% cotton, with non-shrink support 100% PLS		
 Replacement cm 40	T0500340	30
 Replacement cm 60	T0500360	30
 Replacement cm 80	T0500380	30
 Replacement cm 100	T0500310	30
ACRYLIC DUST MOP REPLACEMENT 100% PLS with non-shrink support 100% PLS		
 Replacement cm 40	T0500240	30
 Replacement cm 60	T0500260	30
 Replacement cm 80	T0500280	30
 Replacement cm 100	T0500210	30
 Plastic frame cm 40	A0400201	12
 Plastic frame cm 60	A0400202	12
 Plastic frame cm 80	A0400203	12
 Plastic frame cm 100	A0400204	12
ACRYLIC DUST MOP REPLACEMENT-SQUARE SHAPE 100% PLS with non-shrink support 100% PLS		
 Replacement cm 40	T050024Q	30
 Replacement cm 60	T050026Q	30
 Replacement cm 80	T050028Q	30
 Replacement cm 100	T050021Q	30
COTTON DUST MOP REPLACEMENT-SQUARE SHAPE 50% cotton and 50% polyester with non-shrink support 100% PLS		
 Replacement cm 40	T0500140	30
 Replacement cm 60	T0500160	30
 Replacement cm 80	T0500180	30
Replacement cm 100	T0500110	30







Description
V SWEEPER
 complete with cotton white dust mop and
 chromed handles

code	pcs
ATM10105	6



Description
V SWEEPER
 complete with acrylic blue dust mop
 and chromed handles



code	pcs
ATM10106	6

Description	code	pcs
 Handles for V sweeper in chromed metal with ergonomic grip	ATM1010M	6
 Chromed metal frame with metal pawls for V sweeper	ATM1010P	6
 Cotton replacement for V sweeper (pair) with non-shrink support 100% PLS	TRS10010	12
 Acrylic replacement for V sweeper (pair) with non-shrink support 100% PLS	TRS10020	12

PLANO

FRAME



-  **Ergonomic**
-  **Universal**
-  **Fast**



Ergonomic: Plano washes everywhere thanks to the 0° handle's joint. It can reach under every piece of furniture.



Quick opening and closing of the frame, thanks to the new PadTec double spring system.



Universal: studied to be used for every type of wringer such as vertical, roll and standard one. Suitable to every replacements with pockets or flaps both of TWT and competitors.





Description	code	pcs
PLANO L cm 40 mop frame with universal connector - joint locking system Easy Lock	A0100101	10
PLANO L cm 40 mop frame with universal connector - standard joint locking system	A0100201	10
Kit with plunger and spring for Plano	A0100401	1
Kit with blocking lever for Plano	A0100501	1
Plastic frame cm 40 with magnetic closure	ATP0140A	6









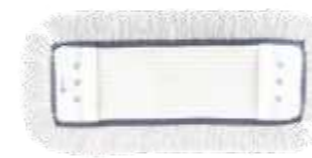







PLANO REPLACEMENTS



Description	code	pcs
 Cotton Mix replacement with tufting, looped ends inside and open ends outside cm 40 with pockets and flaps	T0100141	30
 Cotton Mix replacement with tufting, looped ends inside and open ends outside, flaps with metal eyelets cm 40 with pockets and flaps	T0100141T	30
 TriMax replacement with internal microfiber, cotton and polyester outside, all looped ends cm 40 with pockets and flaps	T0100241	30







	Description	code	pcs
	 SuperSoft white cotton and polyester replacement, looped ends inside and open ends outside cm 40 with pockets and flaps	TRL00440	30
	 Easy microfiber heat treatment replacement with scrub effect cm 40 with pockets and flaps, padded	TRL00140	30
	 Micro color blue microfiber replacement cm 40 with pockets and flaps	TRL1342B	30
	 Micro color red microfiber replacement cm 40 with pockets and flaps	TRL1342R	30
	 Micro color green microfiber replacement cm 40 with pockets and flaps	TRL1342G	30
	 Micro color yellow microfiber replacement cm 40 with pockets and flaps	TRL1342Y	30

	Description	code	pcs
	 MicroBras replacement with abrasive stripes cm 40 with pockets and flaps, padded	TRL00240	30
	 MicroBras Light replacement with abrasive stripes cm 40 with pockets and flaps	TRL00340	30
	 MicroMy white microfiber replacement cm 40 with pockets and flaps, padded	TRL00540	30
	 MicroMy Light white microfiber replacement cm 40 with pockets and flaps	TRL00640	30
	 Microdama replacement with abrasive inserts cm 40 with pockets and flaps, padded	TRL00740	30
	 Microdama Light replacement with abrasive inserts cm 40 with pockets and flaps	TRL00840	30

VOLO

FRAME



-  **Ergonomic**
-  **Non-deformable**
-  **Solid**
-  **Fast**

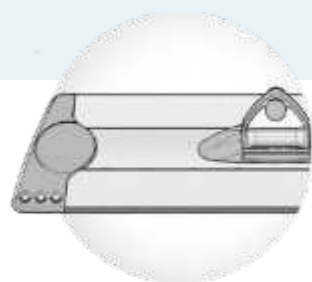

High impact materials.
Non-deformable thanks to the aluminium structure. The orange ends are made of Delrin and elastomers. Impact and wear resistant.



Rubber clips.
Volo can be used with different types of disposable cloths.



Simple.
Volo thanks to the EasyLock mechanism locks the frame in the optimal position for cleaning high surfaces.



Description	code	pcs	
VOLO L cm 40 frame holder in anodized aluminum with velcro and rubber clips, Easy Lock joint oblique terminals	A0200201	10	
VOLO L cm 60 frame holder in anodized aluminum with velcro and rubber clips, Easy Lock joint oblique terminals	A0200301	10	
	Product dimensions	Weight	Packaging dimensions & Volume
A0200201	400 x 95 mm	0,340 kg	500x210x250h mm 0,026 mc
A0200301	600 x 95 mm	0,460 kg	700x210x250h mm 0,036 mc



Description	code	pcs	
VOLO L cm 40 frame holder in anodized aluminum with velcro straight terminals	A0200402	10	
oblique terminals	A0200401	10	
VOLO L cm 60 frame holder in anodized aluminum with velcro straight terminals	A0200502	10	
oblique terminals	A0200501	10	
	Product dimensions	Weight	Packaging dimensions & Volume
A0200402 / 401	400 x 95 mm	0,340 kg	500x210x250h mm 0,026 mc
A0200502 / 501	600 x 95 mm	0,460 kg	700x210x250h mm 0,036 mc



Description	code	pcs	
VOLO P cm 23 pad holder in anodized aluminum with velcro and Easy Lock joint - straight terminals	A0200601	10	
VOLO P cm 30 pad holder in anodized aluminum with velcro and Easy Lock joint - straight terminals	A0200701	10	
	Product dimensions	Weight	Packaging dimensions & Volume
A0200601	230 x 95 mm	0,235 kg	500x210x250h mm 0,026 mc
A0200701	300 x 95 mm	0,260 kg	500x210x250h mm 0,026 mc

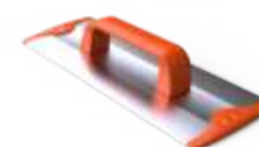

Description	code	pcs	
VOLO M cm 23 pad holder in anodized aluminum with velcro and handle - straight terminals	A0200801	10	
VOLO M cm 30 pad holder in anodized aluminum with velcro and handle - straight terminals	A0200901	10	
	Product dimensions	Weight	Packaging dimensions & Volume
A0200801	230 x 95 mm	0,220 kg	500x210x250h mm 0,026 mc
A0200901	300 x 95 mm	0,260 kg	500x210x250h mm 0,026 mc

VOLO REPLACEMENT WITH **VELCRO STANDARD**

	Description	code	pcs
	MicroDuo microfibre replacement cm 40 with velcro	TRV00100	30
	MicroDuo - Royal microfibre replacement with abrasive inserts cm 40 with velcro	TRV00400	30
	Easy Eco replacement in microfibre microriccio fixed with scrub effect heat treatment cm 40 with velcro	TRV00141	30
	MicroMy white microfibre replacement		
	cm 40 with velcro	TRV00240	30
	cm 60 with velcro	TRV00260	30
	Replacement ROYAL blue cm 40 with velcro	TRV00240.B	30
	MicroBras microfibre replacement with abrasive strips		
	cm 40 with velcro	TRV00340	30
	cm 60 with velcro	TRV00360	30
	Grey cotton and polyester replacement, looped ends		
	cm 40 with velcro	TRV00440	30
	cm 60 with velcro	TRV00460	30
	Cotton replacement, looped ends		
	cm 40 with velcro	TRV00540	30
	cm 60 with velcro	TRV00560	30
	Vaporized microfibre replacement, looped ends		
	cm 40 with velcro	TRV00640	30
	cm 60 with velcro	TRV00660	30

	Description	code	pcs
	Microdama replacement with abrasive inserts		
	cm 40 with velcro	TRV00740	30
	cm 60 with velcro	TRV00760	30
	MicroMix microfibre and cotton replacement, looped ends		
	cm 40 with velcro	TRV00840	30
	cm 60 with velcro	TRV00860	30





VOLO REPLACEMENT WITH **KLETTOSTAR BINDER**

	Description	code	pcs
	MicroDuo microfibre replacement with Microdama inserts, looped ends cm 40 with Klettostar Binder	TRVB0100	30
	MicroDuo - Royal microfibre replacement with abrasive inserts cm 40 with Klettostar Binder	TRVB0400	30
	MicroMy white microfibre replacement		
	cm 40 with Klettostar Binder	TRVB0240	30
	cm 60 with Klettostar Binder	TRVB0260	30
	Replacement ROYAL blue cm 40 with Klettostar Binder	TRVB0240.B	30
	MicroBras microfibre replacement with abrasive strips		
	cm 40 with Klettostar Binder	TRVB0340	30
	cm 60 with Klettostar Binder	TRVB0360	30
	Grey cotton and polyester replacement, looped ends		
	cm 40 with Klettostar Binder	TRVB0440	30
	cm 60 with Klettostar Binder	TRVB0460	30

Description		code	pcs
	Cotton replacement, looped ends		
	cm 40 with Klettostar Binder	TRVB0540	30
	cm 60 with Klettostar Binder	TRVB0560	30
	Vaporized microfiber replacement, looped ends		
	cm 40 with Klettostar Binder	TRVB0640	30
	cm 60 with Klettostar Binder	TRVB0660	30
	Microdama replacement with abrasive inserts		
	cm 40 with Klettostar Binder	TRVB0740	30
	cm 60 with Klettostar Binder	TRVB0760	30
	Microfiber cotton polyester replacement		
	cm 40 with Klettostar Binder	TRVB0840	30
	cm 60 with Klettostar Binder	TRVB0860	30
	Micro Color microfiber replacement - blue		
	cm 40 with Klettostar Binder	TRVB011B	30
	Micro Color microfiber replacement - red		
	cm 40 with Klettostar Binder	TRVB011R	30
	Micro Color microfiber replacement - green		
	cm 40 with Klettostar Binder	TRVB011G	30
	Micro Color microfiber replacement - yellow		
	cm 40 with Klettostar Binder	TRVB011Y	30



EU Ecolabel IT/016/041

Description		code	pcs
	Microfiber replacement cm 40 with Klettostar Binder Blue	TRV00940B	30
	Microfiber replacement cm 40 with Klettostar Binder Red	TRV00940R	30
	Microfiber replacement cm 40 with Klettostar Binder Green	TRV00940G	30
	Microfiber replacement cm 40 with Klettostar Binder Yellow	TRV00940Y	30

SCRUB AND PAD FOR VOLO

Description		code	pcs
	SCRUB M cm 23 plastic pad holder with handle	A15512	10
	SCRUB M cm 23 plastic pad holder with joint	A15513	10
	Abrasive pad for VOLO 23 cm		
	cm 25 - green	T0201101	12
	cm 25 - brown	T0201102	12
	cm 25 - black	T0201103	12
	cm 25 - white	T0201104	12
	Glass Pad cm 32 microfiber pad with velcro suitable for cleaning glass surfaces - compatible with Volo M cm 30	T0200934	30
	Pad Plus Micromy cm 32 microfiber white pad suitable for cleaning all surfaces - compatible with Volo M cm 30	T0201034	30



Description	code	pcs
VOLO SPUGNA aluminum frame with velcro and foam insert, universal connector and Easy Lock joint oblique ends		
cm 40	A0201001	10
cm 50	A0200101	10



SPRY GO	APDEW001	1
---------	-----------------	---



Plastic frame with foam		
cm 40	APS0140A	6
cm 55	APS0160A	6



Foam inserts velcro for VOLO		
cm 40	A0202201	20
cm 50	A0201101	20
cm 60	A0201601	20



Impregnated cloth in polypropilene (Packaged in 20 bags of 50 cloths each)		
cm 60x17	T0201417	1.000
cm 60x22	T0201422	1.000
cm 60x30	T0201430	1.000



Velcro stripe for Volo		
cm 40 (single)	M30145	1
cm 40 (per meter)	M30145GR	

MOP SYSTEM



- Ergonomic
- Non-deformable
- Solid
- Fast



Description	code	pcs
K-MOP Mop holder for mop with universal connector		
with orange connector	A0300101	50
with yellow connector	A0300101Y	50
with green connector	A0300101G	50
with red connector	A0300101R	50
with blue connector	A0300101B	50

K-MOP	Product dimensions	Weight	Packaging dimensions & Volume	
	180x160 mm	0,100 kg	210x800x250h mm	0,042 mc

KENTUCKY MOP



Description	code	pcs
Open-end cotton mop with support - without band		
350 gr	T0300135	50
400 gr	T0300140	50
450 gr	T0300145	50
Open-end cotton mop with support - with band		
350 gr	T0300235	50
400 gr	T0300240	50
450 gr	T0300245	50
Micro Mop - microfiber mop with polyamide		
250 gr	T0300528	30
Mixed polyamide microfiber mop		
350 gr	T0300535	30
Non-woven twist mop		
220 gr	T0300422	50
250 gr	T0300425	50
280 gr	T0300428	50



Descrizione	codice	q.tà
Open-end cotton mop with support - without band ECOLABEL certified		
350 gr	T0300135.EL	50
400 gr	T0300140.EL	50
Open-end cotton mop with support - with band ECOLABEL certified		
350 gr	T0300235.EL	50
400 gr	T0300240.EL	50

MINI - MOP



Description	code	pcs
Cotton mop with thick yarn - thread connector		
250 gr	T0400124	50
280 gr	T0400280	50
Super soft - cotton mop with thin yarn - thread connector		
240 gr	T0600240	50
280 gr	T0600280	50
330 gr	T0600330	50
Micro Strips - microfiber mop - thread connector		
180 gr	T0400318	30
200 gr	T0400320	30
TexPlus - non-woven twist mop - thread connector		
150 gr	T0400514	25
180 gr	T0400518	25

BONNET MOP



Description	code	pcs
Cotton bonnet mop		
33 cm (Ø13")	TMS002	10
43 cm (Ø17")	TMS001	10
Microfiber bonnet mop		
33 cm (Ø13")	TMS003	10
43 cm (Ø17")	TMS004	10

MOP FOR WASHING BAGS

Description	code	pcs
Bag for mop washing 70L with edge		
blue edge	TA0070B	10
yellow edge	TA0070Y	10
red edge	TA0070R	10
green edge	TA0070G	10
Bag for mop washing 90 L with edge		
blue edge	TA0090B	10
yellow edge	TA0090Y	10
red edge	TA0090R	10
green edge	TA0090G	10
Bag for mop washing without edge		
70L	TA0170N	10
90L	TA0190N	10
Bag for mop washing 35 L for Opera trolley		
blue stripes	TA0035B	10
yellow stripes	TA0035Y	10
red stripes	TA0035R	10
green stripes	TA0035G	10
Bag for mop washing 120L with edge for Opera trolley	TA00120	10



AMBO-NEMO

BUCKETS

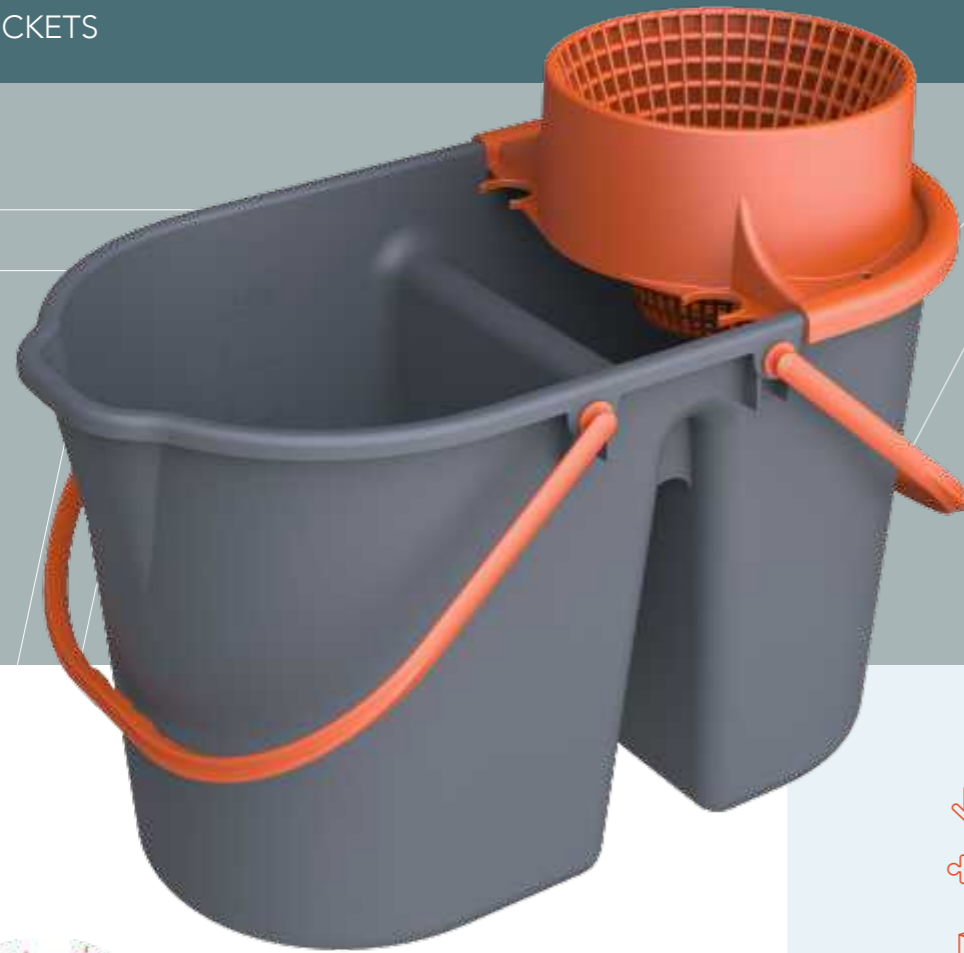

-  **Ergonomic**
-  **Universal**
-  **Solid**



Better hygiene: the surfaces of the buckets are treated with Easy & Clean modality to improve cleanability. The grid on the bottom separates the mop from dirty water, optimizing cleaning and hygiene.



Solid sieve: it is made of polypropylene and its up position allows to maintain the effective capacity of the bucket.



Double bucket 15L: (8 L clean water + 7 L dirty water) allows greater operating autonomy.



Description

code

pcs

AMBO
double vat bucket 15L in PP with sieve

S0400101

10



NEMO
bucket 12 L in PP with sieve

S0400201

10



Double vat bucket 15 L in PP

S0400301

10



Bucket 12 L in PP

S0400401

10



Sieve in PP for Ambo and Nemo buckets

S0400501

1



Grid for Ambo and Nemo buckets

S0400601

1

SURF

FLOOR SQUEEGEES

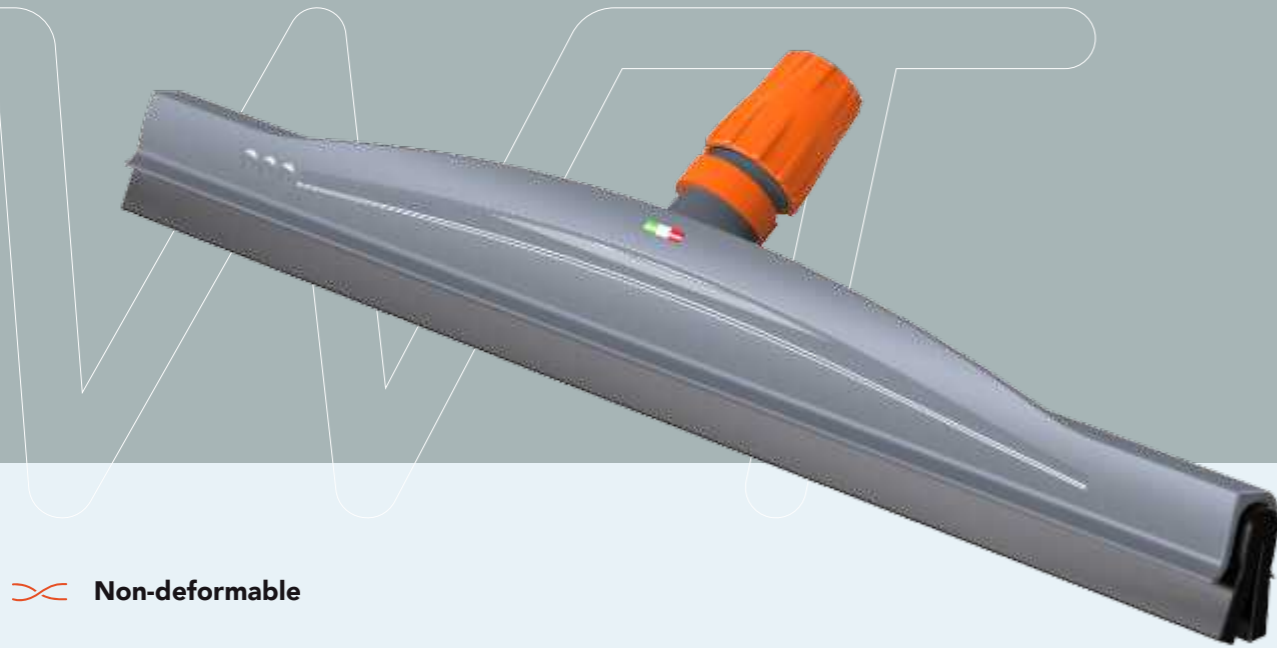

 **Non-deformable**

 **Solid**

 **Fast**

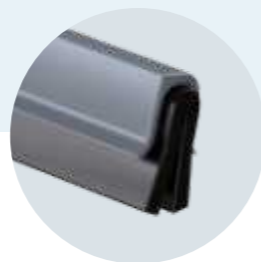

Surf: the particular wave profile and the flap placed above the rubber reduce the escape of splashes after the passage. It works faster and more precisely even on irregular surfaces or when there is a lot of water.

Cloth fastener: the special clips on each side help to fix the cloth to the floor squeegee when it's needed

Rubber: its particular structure improve its ability to manage liquids and its working life



SURF
Plastic squeegee with black rubber foam and universal connector

45 cm

A0500401

10

55 cm

A0500501

10

75 cm

A0500701

10



SURF
Plastic squeegee with red rubber foam and universal connector - for workshops

45 cm

A050180R

10

55 cm

A050190R

10

75cm

A050200R

10



SURF
Plastic squeegee with white rubber foam and universal connector - for alimentary sector

45 cm

A0502101W

10

55 cm

A0502201W

10

75 cm

A0502301W

10



Metal squeegee with black rubber

45 cm

A0501401

12

55 cm

A0501501

12

75 cm

A0501701

12



Universal connector

orange

A0300401

10

blue

A030040B

10

red

A030040R

10

green

A030040G

10

yellow

A030040Y

10

BROOMS

AND DUSTBINS



Description	code	pcs
INDUSTRIAL BROOM in PP recycled bended connector		
cm 45	SCP324	6
cm 60	SCP325	6
INDUSTRIAL BROOM in PP recycled bended connector		
cm 35	SCP135	6
BROOM CLASSIC 35 cm	SCP106	10
SPAZZINA outdoor plastic broom with universal locking ring	A0500302	24
GARDEN outdoor plastic broom	A0500402	24



Description	code	pcs
MAXI plastic dustpan with handle and cover	A0211401	6
FLY plastic dustpan with handle, swing cover and broom	AIS001A	6
STRONG plastic dustpan with handle and black cover	A0201201	6
FLEX hand duster complete with microfiber replacement	AF01	12
Microfiber sleeve for FLEX	AF02	12
DUST dusting tool complete with acrylic sleeve	AF03	10





BROOMS
and HANDLES



HANDLES

Description	code	pcs
-------------	------	-----



ALUMINIUM handles with ergonomic grip

 Aluminium handle with ergonomic grip ø 23 mm, L. 145 cm with hole		
orange cap	A0100601	25
blue cap	A0100601B	25
red cap	A0100601R	25
 Aluminium handle with thread connector 140 cm and ergonomic grip		
orange cap	AMA00214	25
blue cap	AMA00214B	25



ALUMINIUM handles with standard grip

 Telescopic handle with hole and cone 160cm (2x80 cm)	AMA00217	10
 Telescopic handle with thread connector 160cm (2x80 cm)	AMA00316	10
 Aluminium handle ø 23 mm 150 cm		
with thread connector	AMA00114	30
with hole	AMA00113	30

Professional METAL handles

 Metal black handle Ø 23mm x 130cm with thread connector	AMA712	12
 Metal black handle Ø 23mm x 150cm with thread connector	AMA715	12

WOODEN professional handles

 Wooden handle Ø 23mm 150cm with hole and thread connector	A0100701	30
 Wooden handle with hole for Spazzina broom	A0500305	24

OPERA

SERVICE, CLEANING AND HO.RE.CA TROLLEYS



OPERA

SERVICE, CLEANING AND HO.RE.CA TROLLEYS

OPERA trolleys represent the flagship product of TWT's world both for technical development rate and for sales success.

TWT offers its customers the most modern and functional line of multipurpose trolleys: tools with a great aesthetic appearance that enhance the quality of work and the companies' image. OPERA meets the needs of each customer and the demands of each sector, thanks to the wide range of accessories.

-  **Solid**
-  **Manoeuvrable**
-  **Easy to clean**
-  **Versatile**
-  **Silent**
-  **Compact**



CLEANING TROLLEY



HEALTHCARE



SERVICE TROLLEY



HO.RE.CA TROLLEY



OPERA also stands out for the great availability of accessories: as the transparent document holder or Pad holder (the key is placed under the lid for better hygiene) or the innovative frame holder that allows to hold up two frames with their replacements. Opera's doors can be locked to prevent unauthorized access to detergents, accessories or other tools: safety is an important factor in many environments, from healthcare to places frequented by children.

OPERA

SERVICE, CLEANING AND HO.RE.CA TROLLEYS

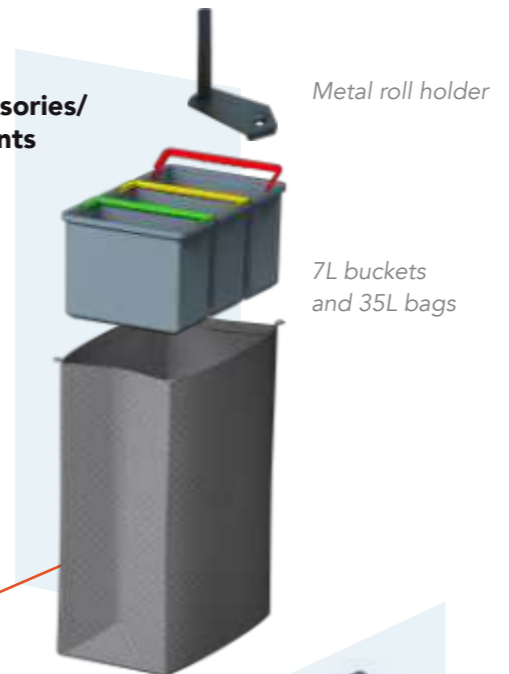
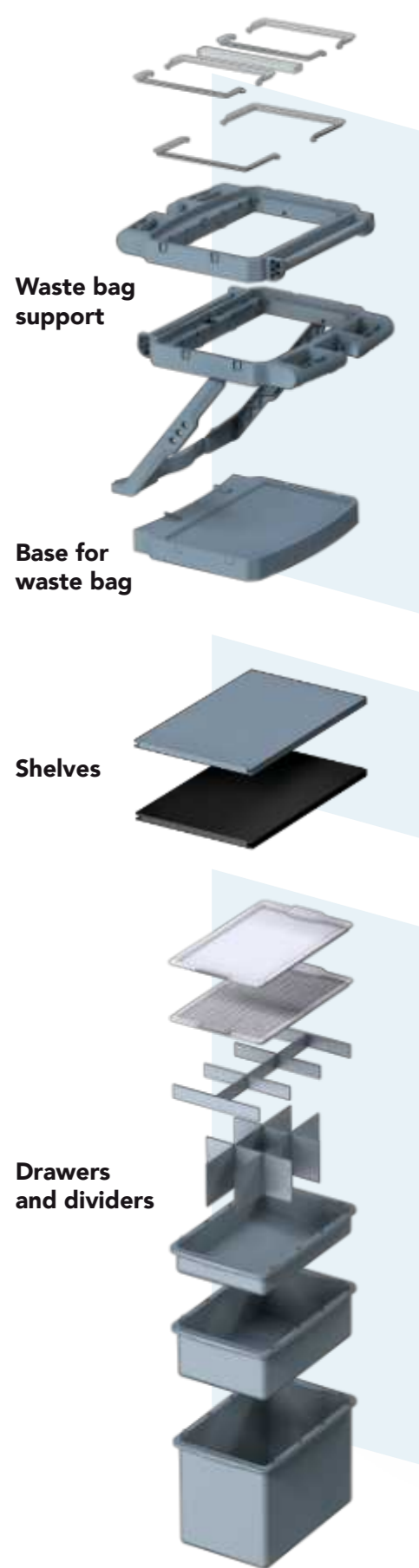

FixT, safety sign holder and metal support

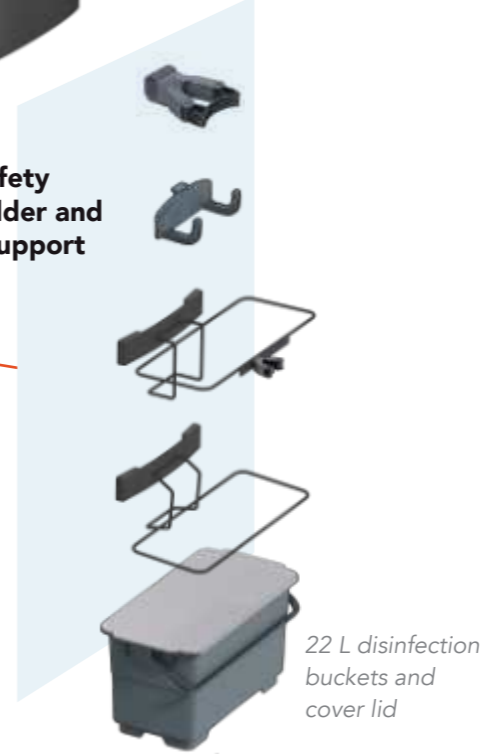

Lateral trays and frame holder

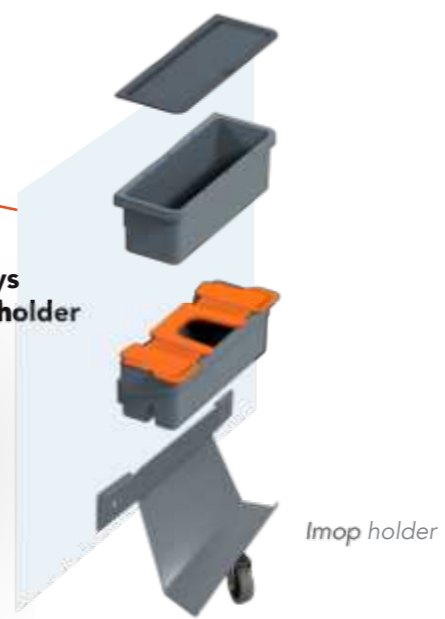

Meets all your needs.

Easy to build and configurable according to your needs, thanks to the different options available between components and accessories.



SPEED SYSTEM

Speed System: the innovative, easy and fast motorized system.

Speed System is a motorized system, that can be applied to all closed Opera trolleys. It is designed to move easily heavy trolleys (weight up to 200kg) over floors or ramps (inclined up to 10%).



- Electric circuit activation with key
- Speed variation on the handle
- Button for changing direction
- Great manoeuvrability thanks to the wheel traction and metal central handle.
- 2 safety brakes to guarantee a high safety standard

Charge autonomy always under control
Up to 40 km of autonomy thanks to the high-capacity battery (12V, 27Ah).

Remaining charge always visible, monitored by the numerical display.

Simple and effective, also in terms of cost: the electrical and mechanical components have been made smaller so the space was optimized.

-  **Solid**
-  **Manoeuvrable**
-  **Silent**
-  **Compact**



High efficiency:
very fast with zero effort

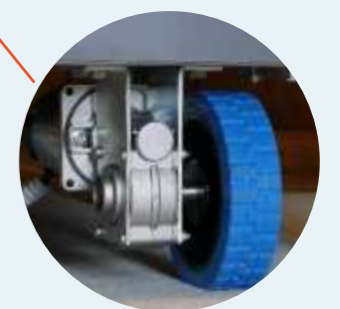

Long-life electric motor
with integrated motorized
wheel Ø150mm



OP0100AR

Components included in the standard configuration	code	pcs
Base in PP with caps and 4 plates	OPK00020	1
Cover dovetail joints in PP for base	OPABA800	4
Wheel, metal, Ø 100mm	MO201RU3	4
Anodized aluminium brackets 810 mm	OPK05020	4
Half top in PP complete with caps and plates	OPK05240	1
Fixing levels for bag 120 L (1pcs) - grey	OPA0066S	2
Bag anchoring kit 6pcs	OPK00120	1
Anodized aluminum pushing handle complete with supports in PP	OPK05110	1
Swivel tray support in grey painted metal 31x22 cm - left	OPASX86S	1
Swivel tray support in grey painted metal 31x22 cm - right	OPADX86S	1
Tray in PP 31x22xh12cm - orange handles	S0202001	2
Support for wringer in grey varnished metal ø20mm	OPK05270	1
Prexa wringer	S0100201	1
15 L bucket in PP - orange handle	S0201501	1
15 L bucket in PP - blue handle	S020150B	1
Safety sign holder in ABS	OPA00990	1
FixT handle holder in ABS with non-slip rubber roller	OPA00820	1

OPTIONAL

Plasticized bag 120L with front zip and logo TWT - grey

code	pcs
OPA00880	1



OP0400AR

Components included in the standard configuration	code	pcs
Base in PP with caps and 4 plates	OPK00020	1
Cover dovetail joints in PP for base	OPABA800	4
Wheel, metal, Ø 100mm	MO201RU3	4
Anodized aluminium brackets 810 mm	OPK05020	4
Half top in PP complete with caps and plates	OPK05240	1
Fixing levels for bag 120 L (1pcs) - grey	OPA0066S	2
Bag anchoring kit 6pcs	OPK00120	1
Anodized aluminum pushing handle complete with supports in PP	OPK05110	1
Support for wringer in grey varnished metal ø20mm	OPK05270	1
Prexa wringer	S0100201	1
15 L bucket in PP - orange handle	S0201501	1
15 L bucket in PP - blue handle	S020150B	1
Safety sign holder in ABS	OPA00990	1
FixT handle holder in ABS with non-slip rubber roller	OPA00820	1

OPTIONAL

Plasticized bag 120L with front zip and logo TWT - grey
 Tray in PP 50x19x16h cm complete with hooks
 Plasticized bag 120L with lateral zip and logo TWT - grey

code	pcs
OPA00880	1
OPK00700	2
OPA00880.L	1



OP0500AR

Components included in the standard configuration	code	pcs
Base in PP with caps and 4 plates	OPK00020	1
Cover dovetail joints in PP for base	OPABA800	2
Cover dovetail joints in PP for lateral panel - right and left	OPADX800 OPASX800	6
Wheel, metal, Ø 100mm	MO201RU3	4
Base for waste bag in PP complete with plug and caps	OPK05160	1
Anodized aluminium brackets 810 mm	OPK05020	4
Back closing panel in ABS	OPKSX030	1
Lateral panel in PP with dovetail joints	OPK00040	4
Door in ABS with key lock - left	OPKSX220	1
Top full size in PP with caps and plates	OPK05060	1
Fixing levels for bag 120 L (1pcs) - grey	OPA0066S	2
Bag anchoring kit 6pcs	OPK00120	1
Anodized aluminum pushing handle complete with supports in PP	OPK05110	2
Cushioned cover lid in PP	OPK0010A	1
Cushioned cover lid in PP with transparent document or Pad holder	OPK0021A	1
Shelf in PP 32x50 cm	OPK00070	1
7L bucket in PP - red handle	OPK0013R	1
7L bucket in PP - blue handle	OPK0013B	1
7L bucket in PP - yellow handle	OPK0013Y	1
Support for wringer in grey varnished metal ø20mm	OPK05270	1
Prexa wringer	S0100201	1
15 L bucket in PP - orange handle	S0201501	1
15 L bucket in PP - blue handle	S020150B	1
Safety sign holder in ABS	OPA00990	1
FixT handle holder in ABS with non-slip rubber roller	OPA00820	1
OPTIONAL	code	pcs
Plasticized bag 120L with front zip and logo TWT - grey	OPA00880	1

Product dimensions 1270x710x1030 mm **Weight** 32 kg **Packaging** 1140x800x500 mm **Volume** 0,456 mc



OP0600AR

Components included in the standard configuration	code	pcs
Base in PP with caps and 4 plates	OPK00020	1
Cover dovetail joints in PP for base	OPABA800	2
Wheel, metal, Ø 100mm	MO201RU3	4
Base for waste bag in PP complete with plug and caps	OPK05160	1
Anodized aluminium brackets 810 mm	OPK05020	4
Top full size in PP with caps and plates	OPK05060	1
Fixing levels for bag 120 L (1pcs) - grey	OPA0066S	2
Bag anchoring kit 6pcs	OPK00120	1
Anodized aluminum pushing handle complete with supports in PP	OPK05110	2
Shelf in PP 32x50 cm	OPK00070	1
7L bucket in PP - red handle	OPK0013R	1
7L bucket in PP - blue handle	OPK0013B	1
10L drawer in PP 45x29xh8,5 cm	OPA00760	1
Drawer support in ABS with stainless steel screw	OPA0070S	8
Support for wringer in grey varnished metal ø20mm	OPK05270	1
Prexa wringer	S0100201	1
15 L bucket in PP - orange handle	S0201501	1
15 L bucket in PP - blue handle	S020150B	1
Safety sign holder in ABS	OPA00990	1
FixT handle holder in ABS with non-slip rubber roller	OPA00820	1
OPTIONAL	code	pcs
Plasticized bag 120L with front zip and logo TWT - grey	OPA00880	1

Product dimensions 1270x710x1220 mm **Weight** 21 kg **Packaging** 1000x700x500 mm **Volume** 0,350 mc



OP0700AR

Components included in the standard configuration	code	pcs
Base in PP with caps and 6 plates	OPK00030	1
Cover dovetail joints in PP for base	OPABA800	4
Wheel, metal, Ø 100mm	MO201RU3	4
Anodized aluminium brackets 810 mm	OPK05020	6
Top full size in PP with caps and plates	OPK05060	1
Fixing levels for bag 120 L (1pcs) - grey	OPA0066S	2
Bag anchoring kit 6pcs	OPK00120	1
Anodized aluminum pushing handle complete with supports in PP	OPK05110	2
Cushioned cover lid in PP	OPK0010A	1
10L drawer in PP 45x29xh8,5 cm	OPA00760	1
Drawer support in ABS with stainless steel screw	OPA0070S	4
7L bucket in PP - red handle	OPK0013R	1
7L bucket in PP - blue handle	OPK0013B	1
7L bucket in PP - yellow handle	OPK0013Y	1
Safety sign holder in ABS	OPA00990	1
FixT handle holder in ABS with non-slip rubber roller	OPA00820	1
OPTIONAL	code	pcs
Plasticized bag 120L with front zip and logo TWT - grey	OPA00880	1
Tray in PP 50x19x16h cm complete with hooks	OPK00700	2



OP0810AR

Components included in the standard configuration	code	pcs
Base in PP with caps and 4 plates	OPK00020	1
Cover dovetail joints in PP for base	OPABA800	2
Cover dovetail joints in PP for lateral panel - right and left	OPADX800 OPASX800	6
Wheel, metal, Ø 100mm	MO201RU3	4
Base for waste bag in PP complete with plug and caps	OPK05160	1
Anodized aluminium brackets 810 mm	OPK05020	4
Lateral panel in PP with dovetail joints	OPK00040	4
Top full size in PP with caps and plates	OPK05060	1
Fixing levels for bag 120 L (1pcs) - grey	OPA0066S	2
Bag anchoring kit 6pcs	OPK00120	1
Anodized aluminum pushing handle complete with supports in PP	OPK05110	2
Shelf in PP 32x50 cm	OPK00070	1
20L drawer in PP 45x29xh16 cm	OPA00770	1
7L bucket in PP - red handle	OPK0013R	1
7L bucket in PP - blue handle	OPK0013B	1
7L bucket in PP - yellow handle	OPK0013Y	1
Safety sign holder in ABS	OPA00990	1
FixT handle holder in ABS with non-slip rubber roller	OPA00820	1
OPTIONAL	code	pcs
Plasticized bag 120L with front zip and logo TWT - grey	OPA00880	1



OP0900AR

Components included in the standard configuration

Base in PP with caps and 4 plates	OPK00020	1
Cover dovetail joints in PP for base	OPABA800	4
Cover dovetail joints in PP for lateral panel - right and left	OPADX800 OPASX800	6
Wheel, metal, Ø 100mm	MO201RU3	4
Anodized aluminium brackets 810 mm	OPK05020	4
Lateral panel in PP with dovetail joints	OPK00040	4
Top full size in PP with caps and plates	OPK05060	1
Fixing levels for bag 120 L (1pcs) - grey	OPA0066S	2
Bag anchoring kit 6pcs	OPK00120	1
Anodized aluminum pushing handle complete with supports in PP	OPK05110	2
Cushioned cover lid in PP with transparent document or Pad holder	OPK0021A	1
Shelf in PP 32x50 cm	OPK00070	1
20L drawer in PP 45x29xh16 cm	OPA00770	1
40L drawer in PP 45x29xh33 cm	OPA00780	1
7L bucket in PP - red handle	OPK0013R	1
7L bucket in PP - blue handle	OPK0013B	1
7L bucket in PP - yellow handle	OPK0013Y	1
Safety sign holder in ABS	OPA00990	1
FixT handle holder in ABS with non-slip rubber roller	OPA00820	1

OPTIONAL

Plasticized bag 120L with front zip and logo TWT - grey	OPA00880	1
---	----------	---

code	pcs
OPK00020	1
OPABA800	4
OPADX800 OPASX800	6
MO201RU3	4
OPK05020	4
OPK00040	4
OPK05060	1
OPA0066S	2
OPK00120	1
OPK05110	2
OPK0021A	1
OPK00070	1
OPA00770	1
OPA00780	1
OPK0013R	1
OPK0013B	1
OPK0013Y	1
OPA00990	1
OPA00820	1

code	pcs
OPA00880	1

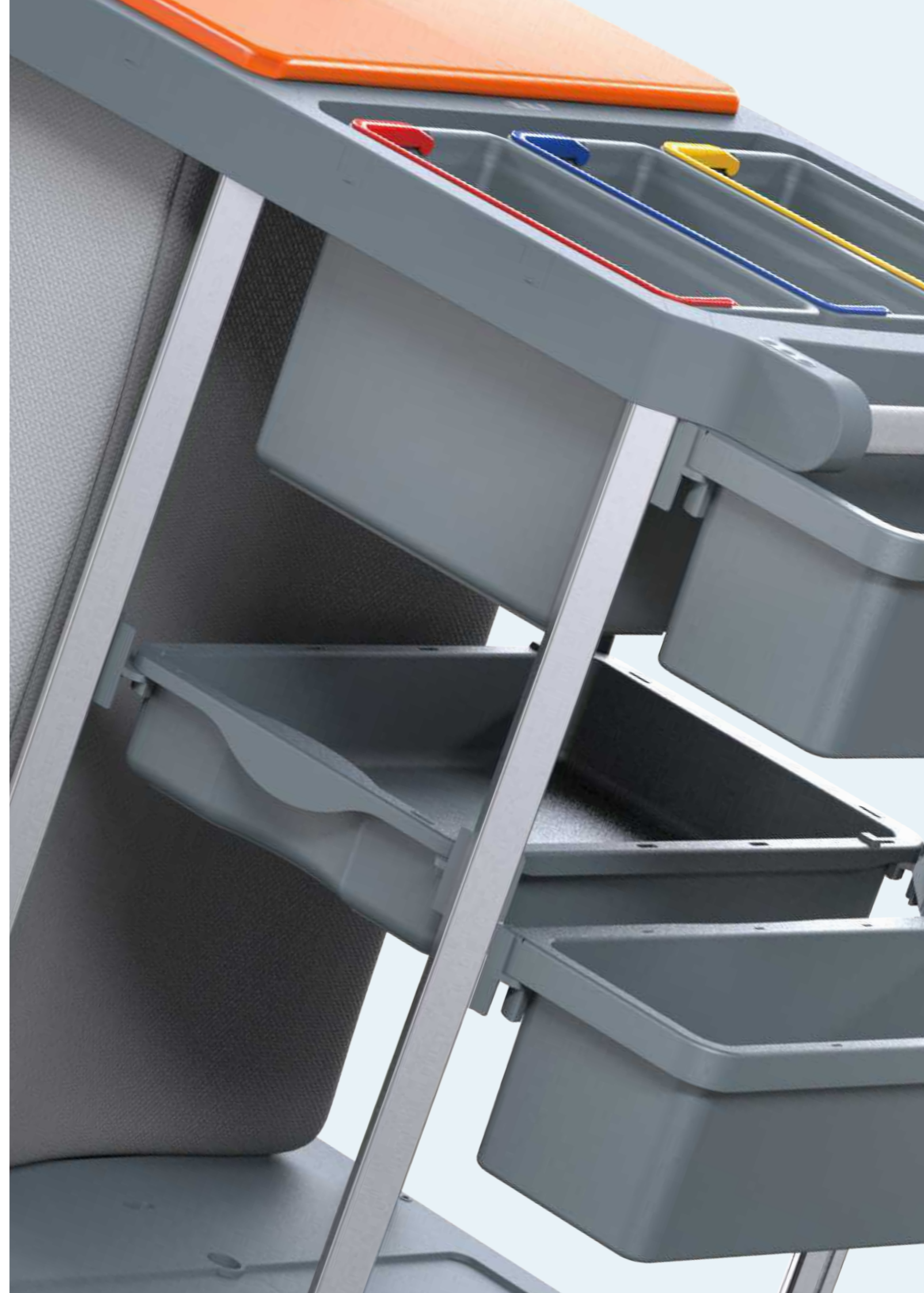



OP1100AR

Components included in the standard configuration	code	pcs
Base in PP with caps and 4 plates	OPK00020	1
Cover dovetail joints in PP for base	OPABA800	2
Cover dovetail joints in PP for lateral panel - right and left	OPADX800 OPASX800	6
Silent Wheel, plastic, Ø125mm	OPA00740	4
Bumpers ø155mm for wheels ø125 mm in PP - grey	OPA00320	4
Base for waste bag in PP complete with plug and caps	OPK05160	1
Bag support 120L in PP complete with lateral support and bag locking rings	OPKC5155	1
Anodized aluminium brackets 810 mm	OPK05020	4
Lateral panel in PP with dovetail joints	OPK00040	4
Back closing panel in ABS	OPKSX030	1
Door in ABS with key lock - left	OPKSX220	1
Half top in PP complete with caps and plates	OPK05240	1
Cushioned cover lid in PP	OPK0010A	1
Cushioned cover lid in PP with transparent document or Pad holder	OPK0021A	1
Shelf in PP 32x50 cm	OPK00070	1
Support for wringer in grey varnished metal ø20mm	OPK05270	1
Prexa wringer	S0100201	1
15 L bucket in PP - orange handle	S0201501	1
15 L bucket in PP - blue handle	S020150B	1
Safety sign holder in ABS	OPA00990	1
FixT handle holder in ABS with non-slip rubber roller	OPA00820	1
OPTIONAL	code	pcs
Plasticized bag 120L with front zip and logo TWT - grey	OPA00880	1
Pedal for lid opening complete with aluminium bar	OPK12005	1
Silent Wheel, plastic, Ø 80mm	S020180G	1

Product dimensions 1410x710x1070 mm **Weight** 33,5kg **Packaging** 1140x800x500 mm **Volume** 0,456 mc



OP1200AR

Components included in the standard configuration	code	pcs
Base in PP with caps and 4 plates	OPK00020	1
Cover dovetail joints in PP for base	OPABA800	2
Cover dovetail joints in PP for lateral panel - right and left	OPADX800 OPASX800	6
Silent Wheel, plastic, Ø125mm	OPA00740	4
Bumpers ø155mm for wheels ø125 mm in PP - grey	OPA00320	4
Base for waste bag in PP complete with plug and caps	OPK05160	1
Bag support 120L in PP complete with lateral support and bag locking rings	OPKC5155	1
Anodized aluminium brackets 810 mm	OPK05020	4
Lateral panel in PP with dovetail joints	OPK00040	4
Back closing panel in ABS	OPKSX030	1
Door in ABS with key lock - left	OPKSX220	1
Half top in PP complete with caps and plates	OPK05240	1
Cushioned cover lid in PP	OPK0010A	1
Cushioned cover lid in PP with transparent document or Pad holder	OPK0021A	1
Shelf in PP 32x50 cm	OPK00070	2
20L drawer in PP 45x29xh16 cm	OPA00770	1
40L drawer in PP 45x29xh33 cm	OPA00780	1
7L bucket in PP - red handle	OPK0013R	1
7L bucket in PP - blue handle	OPK0013B	1
7L bucket in PP - yellow handle	OPK0013Y	1
Support for wringer in grey varnished metal ø20mm	OPK05270	1
Prexa wringer	S0100201	1
15 L bucket in PP - orange handle	S0201501	1
15 L bucket in PP - blue handle	S020150B	1
Safety sign holder in ABS	OPA00990	1
FixT handle holder in ABS with non-slip rubber roller	OPA00820	1
OPTIONAL	code	pcs
Plasticized bag 120L with front zip and logo TWT - grey	OPA00880	1

Product dimensions 1410x710x1070 mm **Weight** 37 kg **Packaging** 1140x800x500 mm **Volume** 0,456 mc



OP2100AR

Components included in the standard configuration	code	pcs
Base in PP with caps and 4 plates	OPK00020	1
Cover dovetail joints in PP for base	OPABA800	4
Cover dovetail joints in PP for lateral panel - right and left	OPADX800 OPASX800	8
Silent Wheel, plastic, Ø125mm	OPA00740	4
Bumpers ø155mm for wheels ø125 mm in PP - grey	OPA00320	4
Anodized aluminium brackets 810 mm	OPK05020	4
Lateral panel in PP with dovetail joints	OPK00040	4
Back closing panel in ABS	OPKSX030	1
Door in ABS with key lock - left	OPKSX220	1
Half top in PP complete with caps and plates	OPK05240	1
Fixing levels for bag 120 L (1pcs) - grey	OPA0066S	2
Bag anchoring kit 6pcs	OPK00120	1
Anodized aluminum pushing handle complete with supports in PP	OPK05110	1
Cushioned cover lid in PP	OPK0010A	1
Support for wringer in grey varnished metal ø20mm	OPK05270	1
Prexa wringer	S0100201	1
15 L bucket in PP - orange handle	S0201501	1
15 L bucket in PP - blue handle	S020150B	1
Safety sign holder in ABS	OPA00990	1
FixT handle holder in ABS with non-slip rubber roller	OPA00820	1



OP2200AR

Components included in the standard configuration	code	pcs
Base in PP with caps and 4 plates	OPK00020	1
Cover dovetail joints in PP for base	OPABA800	4
Cover dovetail joints in PP for lateral panel - right and left	OPADX800 OPASX800	8
Silent Wheel, plastic, Ø125mm	OPA00740	4
Bumpers ø155mm for wheels ø125 mm in PP - grey	OPA00320	4
Anodized aluminium brackets 810 mm	OPK05020	4
Lateral panel in PP with dovetail joints	OPK00040	4
Half top in PP complete with caps and plates	OPK05240	1
Anodized aluminum pushing handle complete with supports in PP	OPK05110	1
Cushioned cover lid in PP	OPK0010A	1
Shelf in PP 32x50 cm	OPK00070	1
20L drawer in PP 45x29xh16 cm	OPA00770	1
40L drawer in PP 45x29xh33 cm	OPA00780	1
7L bucket in PP - red handle	OPK0013R	1
7L bucket in PP - blue handle	OPK0013B	1
7L bucket in PP - yellow handle	OPK0013Y	1
Support for wringer in grey varnished metal ø20mm	OPK05270	1
Prexa wringer	S0100201	1
15 L bucket in PP - orange handle	S0201501	1
15 L bucket in PP - blue handle	S020150B	1
Safety sign holder in ABS	OPA00990	1
FixT handle holder in ABS with non-slip rubber roller	OPA00820	1



OP3100AR

Components included in the standard configuration	code	pcs
Base in PP with caps and 6 plates	OPK00030	1
Cover dovetail joints in PP for base	OPABA800	4
Cover dovetail joints in PP for lateral panel - right and left	OPADX800 OPASX800	8
Silent Wheel, plastic, Ø125mm	OPA00740	4
Bumpers ø155mm for wheels ø125 mm in PP - grey	OPA00320	4
Anodized aluminium brackets 810 mm	OPK05020	6
Lateral panel in PP with dovetail joints	OPK00040	4
Central panel with sliding guides for drawers	OPK00050	2
Back closing panel in ABS	OPKSX030	2
Door in ABS with key lock - right	OPKDX220	1
Door in ABS with key lock - left	OPKSX220	1
Top full size in PP with caps and plates	OPK05060	1
Anodized aluminum pushing handle complete with supports in PP	OPK05110	2
Cushioned cover lid in PP	OPK0010A	2
Shelf in PP 32x50 cm	OPK00070	2
Safety sign holder in ABS	OPA00990	1
FixT handle holder in ABS with non-slip rubber roller	OPA00820	1



OP3200AR

Components included in the standard configuration	code	pcs
Base in PP with caps and 6 plates	OPK00030	1
Cover dovetail joints in PP for base	OPABA800	4
Cover dovetail joints in PP for lateral panel - right and left	OPADX800 OPASX800	8
Silent Wheel, plastic, Ø125mm	OPA00740	4
Bumpers ø155mm for wheels ø125 mm in PP - grey	OPA00320	4
Anodized aluminium brackets 810 mm	OPK05020	6
Lateral panel in PP with dovetail joints	OPK00040	4
Central panel with sliding guides for drawers	OPK00050	2
Back closing panel in ABS	OPKSX030	2
Door in ABS with key lock - right	OPKDX220	1
Door in ABS with key lock - left	OPKSX220	1
Top full size in PP with caps and plates	OPK05060	1
Anodized aluminum pushing handle complete with supports in PP	OPK05110	2
Cushioned cover lid in PP	OPK0010A	2
40L drawer in PP 45x29xh33 cm	OPA00780	4
Safety sign holder in ABS	OPA00990	1
FixT handle holder in ABS with non-slip rubber roller	OPA00820	1



OP4100AR

Components included in the standard configuration	code	pcs
Base in PP with caps and 6 plates	OPK00030	1
Cover dovetail joints in PP for base	OPABA800	2
Cover dovetail joints in PP for lateral panel - right and left	OPADX800 OPASX800	6
Silent Wheel, plastic, Ø125mm	OPA00740	4
Bumpers ø155mm for wheels ø125 mm in PP - grey	OPA00320	4
Base for waste bag in PP complete with plug and caps	OPK05160	1
Bag support 120L in PP complete with lateral support and bag locking rings	OPKC5155	1
Anodized aluminium brackets 810 mm	OPK05020	6
Lateral panel in PP with dovetail joints	OPK00040	4
Central panel with sliding guides for drawers	OPK00050	2
Back closing panel in ABS	OPKSX030	2
Door in ABS with key lock - right	OPKDX220	1
Door in ABS with key lock - left	OPKSX220	1
Top full size in PP with caps and plates	OPK05060	1
Anodized aluminum pushing handle complete with supports in PP	OPK05110	1
Cushioned cover lid in PP	OPK0010A	2
Cushioned cover lid in PP with transparent document or Pad holder	OPK0021A	1
Shelf in PP 32x50 cm	OPK00070	2
Safety sign holder in ABS	OPA00990	1
FixT handle holder in ABS with non-slip rubber roller	OPA00820	1
OPTIONAL		
Plasticized bag 120L with front zip and logo TWT - grey	OPA00880	1

Product dimensions 1475x620xh1070 mm **Weight** 31 kg **Packaging** 1140x800xh500 mm **Volume** 0,456 mc



OP4200AR

Components included in the standard configuration	code	pcs
Base in PP with caps and 6 plates	OPK00030	1
Cover dovetail joints in PP for base	OPABA800	2
Cover dovetail joints in PP for lateral panel - right and left	OPADX800 OPASX800	6
Silent Wheel, plastic, Ø125mm	OPA00740	4
Bumpers ø155mm for wheels ø125 mm in PP - grey	OPA00320	4
Base for waste bag in PP complete with plug and caps	OPK05160	1
Bag support 120L in PP complete with lateral support and bag locking rings	OPKC5155	1
Anodized aluminium brackets 810 mm	OPK05020	6
Lateral panel in PP with dovetail joints	OPK00040	4
Central panel with sliding guides for drawers	OPK00050	2
Back closing panel in ABS	OPKSX030	2
Door in ABS with key lock - right	OPKDX220	1
Door in ABS with key lock - left	OPKSX220	1
Top full size in PP with caps and plates	OPK05060	1
Anodized aluminum pushing handle complete with supports in PP	OPK05110	1
Cushioned cover lid in PP	OPK0010A	2
Cushioned cover lid in PP with transparent document or Pad holder	OPK0021A	1
Shelf in PP 32x50 cm	OPK00070	3
20L drawer in PP 45x29xh16 cm	OPA00770	2
40L drawer in PP 45x29xh33 cm	OPA00780	1
7L bucket in PP - red handle	OPK0013R	1
7L bucket in PP - blue handle	OPK0013B	1
7L bucket in PP - yellow handle	OPK0013Y	1
Safety sign holder in ABS	OPA00990	1
FixT handle holder in ABS with non-slip rubber roller	OPA00820	1
OPTIONAL		
Plasticized bag 120L with front zip and logo TWT - grey	OPA00880	1

code	pcs
OPA00880	1

Product dimensions 1475x620xh1070 mm **Weight** 43 kg **Packaging** 1140x800xh500 mm **Volume** 0,456 mc



OP5100AR

Components included in the standard configuration	code	pcs
Base in PP with caps and 6 plates	OPK00030	1
Cover dovetail joints in PP for lateral panel - right and left	OPADX800 OPASX800	4
Silent Wheel, plastic, Ø125mm	OPA00740	4
Bumpers ø155mm for wheels ø125 mm in PP - grey	OPA00320	4
Base for waste bag in PP complete with plug and caps	OPK05160	2
Bag support 120L in PP complete with lateral support and bag locking rings	OPKC515S	2
Anodized aluminium brackets 810 mm	OPK05020	6
Back closing panel in ABS	OPKSX030	2
Lateral panel in PP with dovetail joints	OPK00040	4
Central panel with sliding guides for drawers	OPK00050	2
Door in ABS with key lock - right	OPKDX220	1
Door in ABS with key lock - left	OPKSX220	1
Top full size in PP with caps and plates	OPK05060	1
Cushioned cover lid in PP	OPK0010A	3
Cushioned cover lid in PP with transparent document or Pad holder	OPK0021A	1
Shelf in PP 32x50 cm	OPK00070	2
Safety sign holder in ABS	OPA00990	1
FixT handle holder in ABS with non-slip rubber roller	OPA00820	1

OPTIONAL

	code	pcs
Plasticized bag 120L with front zip and logo TWT - grey	OPA00880	2
Pedal for lid opening complete with aluminium bar	OPK1200S	2
Silent Wheel, plastic, Ø 80mm	S020180G	2

Product dimensions 1940x620x1070 mm **Weight** 35 kg **Packaging** 1140x800x500 mm **Volume** 0,456 mc



OP5200AR

Components included in the standard configuration	code	pcs
Base in PP with caps and 6 plates	OPK00030	1
Cover dovetail joints in PP for lateral panel - right and left	OPADX800 OPASX800	4
Silent Wheel, plastic, Ø125mm	OPA00740	4
Bumpers ø155mm for wheels ø125 mm in PP - grey	OPA00320	4
Base for waste bag in PP complete with plug and caps	OPK05160	2
Bag support 120L in PP complete with lateral support and bag locking rings	OPKC515S	2
Anodized aluminium brackets 810 mm	OPK05020	6
Back closing panel in ABS	OPKSX030	2
Lateral panel in PP with dovetail joints	OPK00040	4
Central panel with sliding guides for drawers	OPK00050	2
Door in ABS with key lock - right	OPKDX220	1
Door in ABS with key lock - left	OPKSX220	1
Top full size in PP with caps and plates	OPK05060	1
Cushioned cover lid in PP	OPK0010A	3
Cushioned cover lid in PP with transparent document or Pad holder	OPK0021A	1
Shelf in PP 32x50 cm	OPK00070	3
20L drawer in PP 45x29xh16 cm	OPA00770	2
40L drawer in PP 45x29xh33 cm	OPA00780	1
7L bucket in PP - red handle	OPK0013R	1
7L bucket in PP - blue handle	OPK0013B	1
7L bucket in PP - yellow handle	OPK0013Y	1
Safety sign holder in ABS	OPA00990	1
FixT handle holder in ABS with non-slip rubber roller	OPA00820	1

OPTIONAL

	code	pcs
Plasticized bag 120L with front zip and logo TWT - grey	OPA00880	2

Product dimensions 1940x620x1070 mm **Weight** 41,2 kg **Packaging** 1070x700x1090 mm **Volume** 0,810 mc



OP5300AR

Components included in the standard configuration	code	pcs
Base in PP with caps and 6 plates	OPK00030	1
Cover dovetail joints in PP for base	OPABA800	2
Cover dovetail joints in PP for lateral panel - right and left	OPADX800 OPASX800	6
Silent Wheel, plastic, Ø125mm	OPA00740	4
Bumpers ø155mm for wheels ø125 mm in PP - grey	OPA00320	4
Base for waste bag in PP complete with plug and caps	OPK05160	1
Bag support 120L in PP complete with lateral support and bag locking rings	OPKC5155	1
Anodized aluminium brackets 810 mm	OPK05020	5
Lateral panel in PP with dovetail joints	OPK00040	4
Back closing panel in ABS	OPKSX030	2
Door in ABS with key lock - right	OPKDX220	1
Door in ABS with key lock - left	OPKSX220	1
Top full size in PP with caps and plates	OPK05060	1
Anodized aluminum pushing handle complete with supports in PP	OPK05110	1
Cover for closing top in PP	OPA00610	2
Cushioned cover lid in PP with transparent document or Pad holder	OPK0021A	1
Full shelf 50x70 cm made of wood with metal blocking device - black	OPK00690	1
Safety sign holder in ABS	OPA00990	1
FixT handle holder in ABS with non-slip rubber roller	OPA00820	1

OPTIONAL

	code	pcs
Plasticized bag 120L with front zip and logo TWT - grey	OPA00880	1



OP5400AR

Components included in the standard configuration	code	pcs
Base in PP with caps and 6 plates	OPK00030	1
Cover dovetail joints in PP for lateral panel - right and left	OPADX800 OPASX800	4
Silent Wheel, plastic, Ø125mm	OPA00740	4
Bumpers ø155mm for wheels ø125 mm in PP - grey	OPA00320	4
Base for waste bag in PP complete with plug and caps	OPK05160	2
Bag support 120L in PP complete with lateral support and bag locking rings	OPKC5155	2
Anodized aluminium brackets 810 mm	OPK05020	6
Lateral panel in PP with dovetail joints	OPK00040	4
Central panel with sliding guides for drawers	OPK00050	2
Back closing panel in ABS	OPKSX030	2
Door in ABS with key lock - right	OPKDX220	1
Door in ABS with key lock - left	OPKSX220	1
Top full size in PP with caps and plates	OPK05060	1
Cover for closing top in PP	OPA00610	2
Cushioned cover lid in PP	OPK0010A	1
Cushioned cover lid in PP with transparent document or Pad holder	OPK0021A	1
Shelf in PP 32x50 cm	OPK00070	2
10L drawer in PP 45x29xh8,5 cm	OPA00760	1
Safety sign holder in ABS	OPA00990	1
FixT handle holder in ABS with non-slip rubber roller	OPA00820	1

OPTIONAL

	code	pcs
Plasticized bag 120L with front zip and logo TWT - grey	OPA00880	2



OP6200AR

Components included in the standard configuration	code	pcs
Base in PP with caps and 4 plates	OPK00020	1
Cover dovetail joints in PP for base	OPABA800	2
Cover dovetail joints in PP for lateral panel - right and left	OPADX800 OPASX800	10
Silent Wheel, plastic, Ø125mm	OPA00740	4
Bumpers ø155mm for wheels ø125 mm in PP - grey	OPA00320	4
Base for waste bag in PP complete with plug and caps	OPK05160	1
Bag support 120L in PP complete with lateral support and bag locking rings	OPKC5155	1
Anodized aluminium brackets 1241 mm - Maxi	OPK05260	4
Back closing panel in ABS	OPKSX030	1
Back closing panel in ABS - single	OPKSX250	1
Lateral panel in PP with dovetail joints	OPK00040	6
Single door with ABS key lock - left	OPKSX080	1
Half top in PP complete with caps and plates	OPK05240	1
Half top in PP with hole	OPK05430	1
Anodized aluminum pushing handle complete with supports in PP	OPK05110	1
Cover for closing top in PP	OPA00610	2
Cushioned cover lid in PP with transparent document or Pad holder	OPK0021A	1
Shelf in PP 32x50 cm	OPK00070	1
20L drawer in PP 45x29xh16 cm	OPA00770	1
Safety sign holder in ABS	OPA00990	1
FixT handle holder in ABS with non-slip rubber roller	OPA00820	1

OPTIONAL

	code	pcs
Plasticized bag 120L with front zip and logo TWT - grey	OPA00880	1
Pedal for lid opening complete with aluminium bar	OPK12005	1
Silent Wheel, plastic, Ø 80mm	S020180G	1

Product dimensions 1410x620xh1480 mm Weight 38 kg Packaging 1140x800x500 mm Volume 0,456 mc



OP6300AR

Components included in the standard configuration	code	pcs
Base in PP with caps and 4 plates	OPK00020	1
Cover dovetail joints in PP for base	OPABA800	4
Cover dovetail joints in PP for lateral panel - right and left	OPADX800 OPASX800	10
Silent Wheel, plastic, Ø125mm	OPA00740	4
Bumpers ø155mm for wheels ø125 mm in PP - grey	OPA00320	4
Fixing levels for bag 120 L (1pcs) - grey	OPA00665	2
Bag anchoring kit 6pcs	OPK00120	1
Anodized aluminium brackets 1241 mm - Maxi	OPK05260	4
Back closing panel in ABS	OPKSX030	1
Back closing panel in ABS - single	OPKSX250	1
Lateral panel in PP with dovetail joints	OPK00040	6
Half top in PP complete with caps and plates	OPK05240	1
Top full size in PP with hole	OPK05420	1
Anodized aluminum pushing handle complete with supports in PP	OPK05110	3
Cover for closing top in PP	OPA00610	2
Shelf in PP 32x50 cm	OPK00070	1
20L drawer in PP 45x29xh16 cm	OPA00770	1
Safety sign holder in ABS	OPA00990	1
FixT handle holder in ABS with non-slip rubber roller	OPA00820	1

OPTIONAL

	code	pcs
Plasticized bag 120L with front zip and logo TWT - grey	OPA00880	1

Product dimensions 990x620xh1480 mm Weight 30 kg Packaging 1140x800x500 mm Volume 0,456 mc



OP7100AR

Components included in the standard configuration

	code	pcs
Base in PP with caps and 6 plates	OPK00030	1
Cover dovetail joints in PP for lateral panel - right and left	OPADX800 OPASX800	8
Silent Wheel, plastic, Ø125mm	OPA00740	4
Bumpers ø155mm for wheels ø125 mm in PP - grey	OPA00320	4
Base for waste bag in PP complete with plug and caps	OPK05160	2
Bag support 120L in PP complete with lateral support and bag locking rings	OPKC515S	2
Anodized aluminium brackets 1241 mm - Maxi	OPK05260	6
Lateral panel in PP with dovetail joints	OPK00040	6
Central panel with sliding guides for drawers	OPK00050	3
Back closing panel in ABS - single	OPKSX250	2
Back closing panel in ABS	OPKSX030	2
Single door with ABS key lock - right	OPKDX080	1
Single door with ABS key lock - left	OPKSX080	1
Door in ABS with key lock - right	OPKDX220	1
Door in ABS with key lock - left	OPKSX220	1
Top full size in PP with caps and plates	OPK05060	1
Top full size in PP with hole	OPK05420	1
Anodized aluminum pushing handle complete with supports in PP	OPK05110	2
Cover for closing top in PP	OPA00610	4
Cushioned cover lid in PP	OPK0010A	1
Cushioned cover lid in PP with transparent document or Pad holder	OPK0021A	1
Shelf in PP 32x50 cm	OPK00070	2
20L drawer in PP 45x29xh16 cm	OPA00770	2
Safety sign holder in ABS	OPA00990	1
FixT handle holder in ABS with non-slip rubber roller	OPA00820	1

OPTIONAL

	code	pcs
Plasticized bag 120L with front zip and logo TWT - grey	OPA00880	2
Pedal for lid opening complete with aluminium bar	OPK1200S	2
Silent Wheel, plastic, Ø 80mm	S020180G	2

OPERA 7.2 HOTEL

OP7200AR



OP7200AR

Components included in the standard configuration

Base in PP with caps and 6 plates
Cover dovetail joints in PP for lateral panel - right and left
Silent Wheel, plastic, Ø125mm
Bumpers ø155mm for wheels ø125 mm in PP - grey
Base for waste bag in PP complete with plug and caps
Bag support 120L in PP complete with lateral support and bag locking rings
Anodized aluminium brackets 1241 mm - Maxi
Anodized aluminium brackets 450 mm - Mini
Lateral panel in PP with dovetail joints
Central panel with sliding guides for drawers
Back closing panel in ABS - single
Back closing panel in ABS
Top full size in PP with caps and plates
Top full size in PP with hole
Anodized aluminum pushing handle complete with supports in PP
Cover for closing top in PP
Full shelf 50x70 cm made of wood with metal blocking device - black
20L drawer in PP 45x29xh16 cm
Safety sign holder in ABS
FixT handle holder in ABS with non-slip rubber roller

code	pcs
OPK00030	1
OPADX800	8
OPASX800	4
OPA00740	4
OPA00320	4
OPK05160	2
OPKC5155	2
OPK05260	5
OPK05280	1
OPK00040	6
OPK00050	1
OPKSX250	2
OPKSX030	2
OPK05060	1
OPK05420	1
OPK05110	2
OPA00610	4
OPK00690	1
OPA00770	2
OPA00990	1
OPA00820	1

OPTIONAL

Plasticized bag 120L with front zip and logo TWT - grey

code	pcs
OPA00880	2

Product dimensions 1940x620xh1480 mm Weight 49 kg Packaging 1140x800x500 mm Volume 0,456 mc

OPERA 8.4 HOTEL

OP8400AR



OP8400AR

Components included in the standard configuration

Base in PP with caps and 6 plates
Cover dovetail joints in PP for base
Cover dovetail joints in PP for lateral panel - right and left
Silent Wheel, plastic, Ø125mm
Bumpers ø155mm for wheels ø125 mm in PP - grey
Base for waste bag in PP complete with plug and caps
Bag support 120L in PP complete with lateral support and bag locking rings
Anodized aluminium brackets 1241 mm - Maxi
Lateral panel in PP with dovetail joints
Central panel with sliding guides for drawers
Back closing panel in ABS - single
Back closing panel in ABS
Single door with ABS key lock - right
Single door with ABS key lock - left
Door in ABS with key lock - right
Door in ABS with key lock - left
Top full size in PP with caps and plates
Top full size in PP with hole
Anodized aluminum pushing handle complete with supports in PP
Cover for closing top in PP
Cushioned cover lid in PP with transparent document or Pad holder
Shelf in PP 32x50 cm
20L drawer in PP 45x29xh16 cm
Safety sign holder in ABS
FixT handle holder in ABS with non-slip rubber roller

code	pcs
OPK00030	1
OPABA800	2
OPADX800	10
OPASX800	4
OPA00740	4
OPA00320	4
OPK05160	1
OPKC5155	1
OPK05260	6
OPK00040	6
OPK00050	3
OPKSX250	2
OPKSX030	2
OPKDX080	1
OPKSX080	1
OPKDX220	1
OPKSX220	1
OPK05060	1
OPK05420	1
OPK05110	3
OPA00610	4
OPK0021A	1
OPK00070	2
OPA00770	1
OPA00990	1
OPA00820	1

OPTIONAL

Plasticized bag 120L with front zip and logo TWT - grey
Holder for Hotel trolleys with 10 pockets - grey

code	pcs
OPA00880	1
OPA00900	1

Product dimensions 1460x620xh1480 mm Weight 52 kg Packaging 1140x800x500 mm Volume 0,456 mc



OP8500AR

Components included in the standard configuration

	code	pcs
Base in PP with caps and 6 plates	OPK00030	1
Cover dovetail joints in PP for base	OPABA800	2
Cover dovetail joints in PP for lateral panel - right and left	OPADX800 OPASX800	10
Silent Wheel, plastic, Ø125mm	OPA00740	4
Bumpers ø155mm for wheels ø125 mm in PP - grey	OPA00320	4
Base for waste bag in PP complete with plug and caps	OPK05160	1
Bag support 120L in PP complete with lateral support and bag locking rings	OPKC515S	1
Anodized aluminium brackets 1070 mm - Midi	OPK05290	5
Anodized aluminium brackets 290 mm - Extra midi	OPK05295	1
Lateral panel in PP with dovetail joints	OPK00040	4
Lateral panel MIDI in PP with dovetail joints	OPK00040.T	2
Central panel MIDI with sliding guides for drawers	OPK00050.T	1
Back closing panel in ABS	OPKSX030	2
Door in ABS with key lock - right	OPKDX220	1
Door in ABS with key lock - left	OPKSX220	1
Top full size in PP with caps and plates	OPK05060	1
Top full size in PP with hole	OPK05420	1
Anodized aluminum pushing handle complete with supports in PP	OPK05110	3
Cover for closing top in PP	OPA00610	2
Cushioned cover lid in PP	OPK0010A	2
Cushioned cover lid in PP with transparent document or Pad holder	OPK0021A	1
Full shelf 50x70 cm made of wood with metal blocking device - black	OPK00690	1
Shelf in PP 32x50 cm	OPK00070	2
20L drawer in PP 45x29xh16 cm	OPA00770	2
Safety sign holder in ABS	OPA00990	1
FixT handle holder in ABS with non-slip rubber roller	OPA00820	1

OPTIONAL

	code	pcs
Plasticized bag 120L with front zip and logo TWT - grey	OPA00880	1
Silent Wheel, plastic, Ø 80mm	S020180G	1

Product dimensions	1440x620xh1310 mm	Weight	52 kg	Packaging	1070x700x1090 mm	Volume	0,816 mc
---------------------------	-------------------	---------------	-------	------------------	------------------	--------	----------



OP1010AR

Components included in the standard configuration

Base in PP with caps and 6 plates
Cover dovetail joints in PP for base
Wheel, metal, Ø 100mm
Anodized aluminium brackets 810 mm
Top full size in PP with caps and plates
Fixing levels for bag 120 L (1pcs) - grey
Bag anchoring kit 6pcs
Anodized aluminum pushing handle complete with supports in PP
Safety sign holder in ABS
FixT handle holder in ABS with non-slip rubber roller

code	pcs
OPK00030	1
OPABA800	4
MO201RU3	4
OPK05020	4
OPK05060	1
OPA00665	4
OPK00120	2
OPK05110	2
OPA00990	1
OPA00820	1

OPTIONAL

Plasticized bag 120L with front zip and logo TWT - grey

code	pcs
OPA00880	2



OP1020AR

Components included in the standard configuration

Base in PP with caps and 4 plates
Cover dovetail joints in PP for base
Cover dovetail joints in PP for lateral panel - right and left
Wheel, metal, Ø 100mm
Anodized aluminium brackets 810 mm
Lateral panel in PP with dovetail joints
Top full size in PP with caps and plates
Fixing levels for bag 120 L (1pcs) - grey
Bag anchoring kit 6pcs
Anodized aluminum pushing handle complete with supports in PP
Shelf in PP 32x50 cm
20L drawer in PP 45x29xh16 cm
Safety sign holder in ABS
FixT handle holder in ABS with non-slip rubber roller

code	pcs
OPK00020	1
OPADX800	8
OPASX800	4
OPABA800	4
MO201RU3	4
OPK05020	4
OPK00040	4
OPK05060	1
OPA00665	2
OPK00120	1
OPK05110	2
OPK00070	1
OPA00770	1
OPA00990	1
OPA00820	1

OPTIONAL

Plasticized bag 120L with front zip and logo TWT - grey

code	pcs
OPA00880	1



OP1050AR

Components included in the standard configuration

	code	pcs
Base in PP with caps and 6 plates	OPK00030	1
Cover dovetail joints in PP for base	OPABA800	4
Wheel, metal, Ø 100mm	MO201RU3	4
Anodized aluminium brackets 810 mm	OPK05020	4
Bag holder ring in painted metal	OPA00955	1
Laudry bag 260L with lid	OPA00850	1



OP2400AR

Components included in the standard configuration

	code	pcs
Compact base in PP with 4 plates	OPK00C11	1
Cover dovetail joints in PP for base	OPABA800	4
Silent Wheel, plastic, Ø125mm	OPA00740	4
Bumpers ø155mm for wheels ø125 mm in PP - grey	OPA00320	4
Anodized aluminium brackets 1241 mm - Maxi	OPK05260	4
Half top in PP complete with caps and plates	OPK05240	1
Anodized aluminum pushing handle complete with supports in PP	OPK05110	1
Vertical laundry bag 200L with frontal zip - grey	OPA00810	1
Cushioned cover lid in PP	OPK0010A	1



OP9100AR

Components included in the standard configuration		code	pcs
Base in PP with caps and 6 plates		OPK00030	1
Cover dovetail joints in PP for base		OPABA800	4
Cover dovetail joints in PP for lateral panel - right and left		OPADX800 OPASX800	8
Silent Wheel, plastic, Ø125mm		OPA00740	4
Bumpers ø155mm for wheels ø125 mm in PP - grey		OPA00320	4
Anodized aluminium brackets 810 mm		OPK05020	6
Lateral panel in PP with dovetail joints		OPK00040	4
Central panel with sliding guides for drawers		OPK00050	2
Back closing panel in ABS		OPKSX030	2
Top full size in PP with caps and plates		OPK05060	1
Anodized aluminum pushing handle complete with supports in PP		OPK05110	2
Shelf in PP 32x50 cm		OPK00070	4
OPTIONAL		code	pcs
Tray in PP 50x19xh16 cm		OPA00700	2

Product dimensions 990x620xh1050 mm Weight 25 kg Packaging 1000x700x500 mm Volume 0,350 mc



OP9300AR

Components included in the standard configuration		code	pcs
Base in PP with caps and 6 plates		OPK00030	1
Cover dovetail joints in PP for base		OPABA800	4
Cover dovetail joints in PP for lateral panel - right and left		OPADX800 OPASX800	8
Silent Wheel, plastic, Ø125mm		OPA00740	4
Bumpers ø155mm for wheels ø125 mm in PP - grey		OPA00320	4
Anodized aluminium brackets 810 mm		OPK05020	6
Lateral panel in PP with dovetail joints		OPK00040	4
Central panel with sliding guides for drawers		OPK00050	2
Back closing panel in ABS		OPKSX030	2
Top full size in PP with caps and plates		OPK05060	1
Anodized aluminum pushing handle complete with supports in PP		OPK05110	2
Shelf in PP 32x50 cm		OPK00070	2
40L drawer in PP 45x29xh33 cm		OPA00780	4

Product dimensions 990x620xh1050 mm Weight 36 kg Packaging 1140x800x500 mm Volume 0,456 mc



OP9400AR

Components included in the standard configuration	code	pcs
Base in PP with caps and 6 plates	OPK00030	1
Cover dovetail joints in PP for base	OPABA800	4
Cover dovetail joints in PP for lateral panel - right and left	OPADX800 OPASX800	8
Silent Wheel, plastic, Ø125mm	OPA00740	4
Bumpers ø155mm for wheels ø125 mm in PP - grey	OPA00320	4
Anodized aluminium brackets 810 mm	OPK05020	6
Lateral panel in PP with dovetail joints	OPK00040	4
Central panel with sliding guides for drawers	OPK00050	2
Back closing panel in ABS	OPKSX030	2
Door in ABS with key lock - right	OPKDX220	1
Door in ABS with key lock - left	OPKSX220	1
Top full size in PP with caps and plates	OPK05060	1
Anodized aluminum pushing handle complete with supports in PP	OPK05110	2
Cover for closing top in PP	OPA00610	2
20L drawer in PP 45x29xh16 cm	OPA00770	8
Safety sign holder in ABS	OPA00990	1
FixT handle holder in ABS with non-slip rubber roller	OPA00820	1

Product dimensions 990x620xh1050 mm **Weight** 38 kg **Packaging** 1140x800x500 mm **Volume** 0,456 mc



OP1110AR

Components included in the standard configuration	code	pcs
Base in PP with caps and 6 plates	OPK00030	1
Cover dovetail joints in PP for base	OPABA800	2
Cover dovetail joints in PP for lateral panel - right and left	OPADX800 OPASX800	2
Silent Wheel, plastic, Ø125mm	OPA00740	4
Bumpers ø155mm for wheels ø125 mm in PP - grey	OPA00320	4
Base for waste bag in PP complete with plug and caps	OPK05160	1
Bag support 120L in PP complete with lateral support and bag locking rings	OPKC515S	1
Anodized aluminium brackets 810 mm	OPK05020	4
Lateral panel in PP with dovetail joints	OPK00040	4
Back closing panel in ABS	OPKSX030	1
Door in ABS with key lock - left	OPKSX220	1
Half top in PP complete with caps and plates	OPK05240	1
Cushioned cover lid in PP	OPK0010A	1
Cushioned cover lid in PP with transparent document or Pad holder	OPK0021A	1
Shelf in PP 32x50 cm	OPK00070	1
7L bucket in PP - red handle	OPK0013R	1
7L bucket in PP - blue handle	OPK0013B	1
7L bucket in PP - yellow handle	OPK0013Y	1
Varnished metal support support for 22L bucket complete with 1 FixT - upper	OPA0C88S	1
Varnished metal support support for 22L bucket - lower	OPA0089S	1
22L disinfection bucket in PP	V13500	2
Safety sign holder in ABS	OPA00990	1
FixT handle holder in ABS with non-slip rubber roller	OPA00820	1
OPTIONAL	code	pcs
Plasticized bag 120L with front zip and logo TWT - grey	OPA00880	1
Lid for 22L disinfection bucket	V13501	2

Product dimensions 1410x620x1070 mm Weight 33 kg Packaging 1140x800x500 mm Volume 0,456 mc



OP1120AR

Components included in the standard configuration	code	pcs
Base in PP with caps and 6 plates	OPK00030	1
Cover dovetail joints in PP for base	OPABA800	2
Cover dovetail joints in PP for lateral panel - right and left	OPADX800 OPASX800	2
Silent Wheel, plastic, Ø125mm	OPA00740	4
Bumpers ø155mm for wheels ø125 mm in PP - grey	OPA00320	4
Base for waste bag in PP complete with plug and caps	OPK05160	1
Bag support 120L in PP complete with lateral support and bag locking rings	OPKC515S	1
Anodized aluminium brackets 810 mm	OPK05020	6
Lateral panel in PP with dovetail joints	OPK00040	4
Central panel with sliding guides for drawers	OPK00050	2
Back closing panel in ABS	OPKSX030	2
Door in ABS with key lock - right	OPKDX220	1
Door in ABS with key lock - left	OPKSX220	1
Top full size in PP with caps and plates	OPK05060	1
Anodized aluminum pushing handle complete with supports in PP	OPK05110	1
Cushioned cover lid in PP	OPK0010A	2
Cushioned cover lid in PP with transparent document or Pad holder	OPK0021A	1
Shelf in PP 32x50 cm	OPK00070	2
7L bucket in PP - red handle	OPK0013R	1
7L bucket in PP - blue handle	OPK0013B	1
7L bucket in PP - yellow handle	OPK0013Y	1
Varnished metal support support for 22L bucket complete with 1 FixT - upper	OPA0C88S	1
Varnished metal support support for 22L bucket - lower	OPA0089S	1
22L disinfection bucket in PP	V13500	2
Safety sign holder in ABS	OPA00990	1
FixT handle holder in ABS with non-slip rubber roller	OPA00820	1
OPTIONAL	code	pcs
Plasticized bag 120L with front zip and logo TWT - grey	OPA00880	1
Lid for 22L disinfection bucket	V13501	2

Product dimensions 1770x620x1070 mm Weight 40 kg Packaging 1070x700x1090 mm Volume 0,816 mc



OP1130AR

Components included in the standard configuration

Base in PP with caps and 4 plates
Cover dovetail joints in PP for base
Cover dovetail joints in PP for lateral panel - right and left
Silent Wheel, plastic, Ø125mm
Bumpers ø155mm for wheels ø125 mm in PP - grey
Anodized aluminium brackets 810 mm
Half top in PP complete with caps and plates
Lever holding bag for 2x70L- grey
Bag anchoring kit 6pcs
Central outer panel in PP
Anodized aluminum pushing handle complete with supports in PP
Cushioned cover lid in PP
Swivel tray support in grey painted metal 31x22 cm - left
Swivel tray support in grey painted metal 31x22 cm - right
Tray in PP 31x22xh12cm - orange handles
Varnished metal support support for 22L bucket complete with 1 FixT - upper
Varnished metal support support for 22L bucket - lower
22L disinfection bucket in PP
Safety sign holder in ABS
FixT handle holder in ABS with non-slip rubber roller

OPTIONAL

Plasticized bag 120L with front zip and logo TWT - grey
Lid for 22L disinfection bucket

code	pcs
OPK00020	1
OPABA800	4
OPADX800	4
OPASX800	4
OPA00740	4
OPA00320	4
OPK05020	4
OPK05240	1
OPK11175	1
OPK00120	1
OPK05330	2
OPK05110	1
OPK0010A	1
OPASX86S	1
OPADX86S	1
S0202001	2
OPA0C88S	1
OPA0089S	1
V13500	2
OPA00990	1
OPA00820	1

code	pcs
OPA00880	1
V13501	2

Product dimensions 920x620xh1190 mm Weight 22 kg Packaging 100x700xh500 mm Volume 0,350 mc



OP1140AR



Components included in the standard configuration

Base in PP with caps and 6 plates
Cover dovetail joints in PP for base
Cover dovetail joints in PP for lateral panel - right and left
Silent Wheel, plastic, Ø125mm
Bumpers ø155mm for wheels ø125 mm in PP - grey
Anodized aluminium brackets 810 mm
Lateral panel in PP with dovetail joints
Central panel with sliding guides for drawers
Back closing panel in ABS
Door in ABS with key lock - right
Door in ABS with key lock - left
Top full size in PP with caps and plates
Lever holding bag for 2x70L- grey
Bag anchoring kit 6pcs
Plasticized bag 35L - grey
Anodized aluminum pushing handle complete with supports in PP
FixT handle holder in ABS with non-slip rubber roller for pushing handle
Cushioned cover lid in PP
Cushioned cover lid in PP with transparent document or Pad holder
Shelf in PP 32x50 cm
20L drawer in PP 45x29xh16 cm
40L drawer in PP 45x29xh33 cm
7L bucket in PP - red handle
7L bucket in PP - blue handle
7L bucket in PP - yellow handle
Varnished metal support support for 22L bucket complete with 1 FixT - upper
Varnished metal support support for 22L bucket - lower
22L disinfection bucket in PP
Safety sign holder in ABS
FixT handle holder in ABS with non-slip rubber roller

OPTIONAL

Lid for 22L disinfection bucket

code	pcs
OPK00030	1
OPABA800	4
OPADX800	4
OPASX800	4
OPA00740	4
OPA00320	4
OPK05020	6
OPK00040	4
OPK00050	2
OPKSX030	2
OPKDX220	1
OPKSX220	1
OPK05060	1
OPK11175	1
OPK00120	1
OPA00890	2
OPK05110	2
OPK05130	1
OPK0010A	1
OPK0021A	1
OPK00070	2
OPA00770	3
OPA00780	1
OPK0013R	1
OPK0013B	1
OPK0013Y	1
OPA0C88S	1
OPA0089S	1
V13500	2
OPA00990	1
OPA00820	1

code	pcs
V13501	2

Product dimensions 1300x620xh1070 mm Weight 42 kg Packaging 1070x700xh1090 mm Volume 0,816 mc



OP1150AR

Components included in the standard configuration	code	pcs
Base in PP with caps and 6 plates	OPK00030	1
Cover dovetail joints in PP for base	OPABA800	4
Cover dovetail joints in PP for lateral panel - right and left	OPADX800 OPASX800	4
Silent Wheel, plastic, Ø125mm	OPA00740	4
Bumpers ø155mm for wheels ø125 mm in PP - grey	OPA00320	4
Anodized aluminium brackets 810 mm	OPK05020	6
Lateral panel in PP with dovetail joints	OPK00040	4
Central panel with sliding guides for drawers	OPK00050	2
Back closing panel in ABS	OPKSX030	2
Door in ABS with key lock - right	OPKDX220	1
Door in ABS with key lock - left	OPKSX220	1
Top full size in PP with caps and plates	OPK05060	1
Bag anchoring kit 6pcs	OPK00120	1
Fixing levels for bag 120 L (1pcs) - grey	OPA0066S	2
Anodized aluminum pushing handle complete with supports in PP	OPK05110	2
Cushioned cover lid in PP	OPK0010A	1
Cushioned cover lid in PP with transparent document or Pad holder	OPK0021A	1
Shelf in PP 32x50 cm	OPK00070	1
7L bucket in PP - red handle	OPK0013R	1
7L bucket in PP - blue handle	OPK0013B	1
7L bucket in PP - yellow handle	OPK0013Y	1
10L drawer in PP 45x29xh8,5 cm	OPA00760	1
Varnished metal support support for 22L bucket complete with 1 FixT - upper	OPA0C88S	1
Varnished metal support support for 22L bucket - lower	OPA0089S	1
22L disinfection bucket in PP	V13500	2
Safety sign holder in ABS	OPA00990	1
FixT handle holder in ABS with non-slip rubber roller	OPA00820	1

OPTIONAL	code	pcs
Lid for 22L disinfection bucket	V13501	2

Product dimensions 1300x620xh1070 mm Weight 40 kg Packaging 1140x800xh500 mm Volume 0,456 mc



OP1180AR

Components included in the standard configuration	code	pcs
Base in PP with caps and 6 plates	OPK00030	1
Cover dovetail joints in PP for base	OPABA800	2
Cover dovetail joints in PP for lateral panel - right and left	OPADX800 OPASX800	6
Kit fixed wheels ø245mm in polyurethane with screws and 2 supports	OPK0024S	1
Rubber wheel for outdoor Ø150mm with screw Ø10 MA	OPA0100	2
Anodized aluminium brackets 810 mm	OPK05020	6
Lateral panel in PP with dovetail joints	OPK00040	4
Central panel with sliding guides for drawers	OPK00050	2
Back closing panel in ABS	OPKSX030	2
Door in ABS with key lock - right	OPKDX220	1
Door in ABS with key lock - left	OPKSX220	1
Top full size in PP with caps and plates	OPK05060	1
Bag anchoring kit 6pcs	OPK00120	1
Fixing levels for bag 120 L (1pcs) - grey	OPA0066S	2
Plasticized bag 35L - grey	OPA00890	2
Anodized aluminum pushing handle complete with supports in PP	OPK05110	2
Cushioned cover lid in PP	OPK0010A	2
Shelf in PP 32x50 cm	OPK00070	2
20L drawer in PP 45x29xh16 cm	OPA00770	1
40L drawer in PP 45x29xh33 cm	OPA00780	1
7L bucket in PP - red handle	OPK0013R	1
7L bucket in PP - blue handle	OPK0013B	1
7L bucket in PP - yellow handle	OPK0013Y	1
Tray in PP 50x19xh16 cm	OPA00700	2
Safety sign holder in ABS	OPA00990	1
FixT handle holder in ABS with non-slip rubber roller	OPA00820	1

Product dimensions 1090x620xh1080 mm Weight 41 kg Packaging 1140x800xh500 mm Volume 0,456 mc



OP2500AR

Components included in the standard configuration

Compact base in PP with 4 plates
Cover dovetail joints in PP for base
Cover dovetail joints in PP for lateral panel - right and left
Silent Wheel, plastic, Ø125mm
Bumpers ø155mm for wheels ø125 mm in PP - grey
Anodized aluminium brackets 1241 mm - Maxi
Lateral panel in PP with dovetail joints
Back closing panel in ABS
Back closing panel in ABS - single
Single door with ABS key lock - left
Door in ABS with key lock - left
Half top in PP complete with caps and plates
Half top in PP with hole
Anodized aluminum pushing handle complete with supports in PP
Cover for closing top in PP
Shelf in PP 32x50 cm
20L drawer in PP 45x29xh16 cm

code	pcs
OPK00C11	1
OPABA800	4
OPADX800	12
OPASX800	
OPA00740	4
OPA00320	4
OPK05260	4
OPK00040	6
OPKSX030	1
OPKSX250	1
OPKSX080	1
OPKSX220	1
OPK05240	1
OPK05430	1
OPK05110	2
OPA00610	2
OPK00070	1
OPA00770	1



OP2700AR

Components included in the standard configuration

Compact base in PP with 4 plates
Cover dovetail joints in PP for base
Cover dovetail joints in PP for lateral panel - right and left
Silent Wheel, plastic, Ø125mm
Bumpers ø155mm for wheels ø125 mm in PP - grey
Anodized aluminium brackets 810 mm
Lateral panel in PP with dovetail joints
Back closing panel in ABS
Door in ABS with key lock - left
Half top in PP complete with caps and plates
Anodized aluminum pushing handle complete with supports in PP
Cushioned cover lid in PP
Shelf in PP 32x50 cm
20L drawer in PP 45x29xh16 cm

code	pcs
OPK00C11	1
OPABA800	4
OPADX800	8
OPASX800	
OPA00740	4
OPA00320	4
OPK05020	4
OPK00040	4
OPKSX030	1
OPKSX220	1
OPK05240	1
OPK05110	1
OPK0010A	1
OPK00070	1
OPA00770	1



OP20100AR

Components included in the standard configuration

	code	pcs
Base in PP with caps and 6 plates	OPK00030	1
Compact base in PP with 4 plates	OPK00C11	1
Cover dovetail joints in PP for base	OPABA800	6
Cover dovetail joints in PP for lateral panel - right and left	OPADX800 OPASX800	22
Silent Wheel, plastic, Ø125mm	OPA00740	8
Bumpers ø155mm for wheels ø125 mm in PP - grey	OPA00320	8
Base for waste bag in PP complete with plug and caps	OPK05160	1
Bag support 120L in PP complete with lateral support and bag locking rings	OPKC515S	1
Anodized aluminium brackets 1241 mm - Maxi	OPK05260	10
Lateral panel in PP with dovetail joints	OPK00040	12
Central panel with sliding guides for drawers	OPK00050	3
Back closing panel in ABS - single	OPKSX250	3
Back closing panel in ABS	OPKSX030	3
Single door with ABS key lock - right	OPKDX080	1
Single door with ABS key lock - left	OPKSX080	2
Door in ABS with key lock - right	OPKDX220	1
Door in ABS with key lock - left	OPKSX220	2
Top full size in PP with caps and plates	OPK05060	1
Top full size in PP with hole	OPK05420	1
Half top in PP complete with caps and plates	OPK05240	1
Half top in PP with hole	OPK05430	1
Anodized aluminum pushing handle complete with supports in PP	OPK05110	4
Cover for closing top in PP	OPA00610	6
Cushioned cover lid in PP with transparent document or Pad holder	OPK0021A	1
Shelf in PP 32x50 cm	OPK00070	3
20L drawer in PP 45x29xh16 cm	OPA00770	3
Right and left coupling kit complete with plugs for Van Opera	OPK0090	1
Safety sign holder in ABS	OPA00990	1
FixT handle holder in ABS with non-slip rubber roller	OPA00820	1

OPTIONAL

	code	pcs
Plasticized bag 120L with front zip and logo TWT - grey	OPA00880	1
Pedal for lid opening complete with aluminium bar	OPK1200S	1
Silent Wheel, plastic, Ø 80mm	S020180G	1

Product dimensions	2060x620xh1480 mm	Weight	75 kg	Packaging	1140x800xh500 mm + 800x1200x1050 mm	Volume	1,464 mc
---------------------------	-------------------	---------------	-------	------------------	--	---------------	----------



OP20200AR

Standard configuration









Components included in the standard configuration

	code	pcs
Base in PP with caps and 4 plates	OPK00020	1
Compact base in PP with 4 plates	OPK00C11	1
Cover dovetail joints in PP for base	OPABA800	8
Cover dovetail joints in PP for lateral panel - right and left	OPADX800 OPASX800	16
Silent Wheel, plastic, Ø125mm	OPA00740	8
Bumpers ø155mm for wheels ø125 mm in PP - grey	OPA00320	8
Anodized aluminium brackets 810 mm	OPK05020	8
Lateral panel in PP with dovetail joints	OPK00040	8
Back closing panel in ABS	OPKSX030	2
Door in ABS with key lock - left	OPKSX220	2
Half top in PP complete with caps and plates	OPK05240	2
Anodized aluminum pushing handle complete with supports in PP	OPK05110	1
Cushioned cover lid in PP	OPK0010A	2
Shelf in PP 32x50 cm	OPK00070	2
Support for wringer in grey varnished metal ø20mm	OPK05270	1
Prexa wringer	S0100201	1
15 L bucket in PP - orange handle	S0201501	1
15 L bucket in PP - blue handle	S020150B	1
7L bucket in PP - red handle	OPK0013R	1
7L bucket in PP - blue handle	OPK0013B	1
7L bucket in PP - yellow handle	OPK0013Y	1
20L drawer in PP 45x29xh16 cm	OPA00770	2
Right and left coupling kit complete with plugs for Van Opera	OPK00090	1
Safety sign holder in ABS	OPA00990	1
FixT handle holder in ABS with non-slip rubber roller	OPA00820	1

Product dimensions 1520x620xh1070 mm **Weight** 55 kg **Packaging** 1140x800xh500 mm + 1000x700x500 mm **Volume** 0,806 mc



Description	code	pcs
Base in PP with caps and 4 plates	OPK00020	1
Base in PP with caps and 6 plates	OPK00030	1
Compact base in PP with 4 plates	OPK00C11	1
Cover dovetail joints in PP for base	OPABA800	1
Base for waste bag in PP complete with plug and caps	OPK05160	1
Base for waste bag in PP with Silent Wheel Ø 80mm	OPKC0560	1
Half top in PP complete with caps and plates	OPK05240	1
Half top in PP with hole	OPK05430	1
Top full size in PP with caps and plates	OPK05060	1
Top full size in PP with hole	OPK05420	1
Bag support 120L in PP complete with lateral support and bag locking rings	OPKC515S	1
Fixing levels for bag 120 L (1pcs) - grey	OPA0066S	1
Kit fixing levels for bag 120 L (2pcs) - grey	OPK067S	1
Lever holding for bag 2x70L - grey	OPK1117S	1
Bag anchoring kit 6pcs	OPK00120	1
Bag holder kit 40L in PP with red, blue, yellow handle	OPK300	1

Description	code	pcs
 Silent Wheel, plastic, Ø 80mm	S020180G	1
 Wheel, metal, Ø 100mm	MO201RU3	1
 Silent Wheel, plastic, Ø125mm	OPA00740	1
 Silent Wheel, plastic, Ø125mm with screw Ø10 MA with brake	OPA00740F	1
 Wheel for moquette Ø125mm with screw Ø10 MA	OPA0090G	1
 Rubber wheel for outdoor Ø150mm with screw Ø10 MA	OPA0100	1
 Fixed wheels ø245mm in polyurethane with screws and 2 supports	OPKR00245	1
 Bumper ø155mm for wheels ø125 mm in PP - grey	OPA00320	1
Anodized aluminium brackets 450 mm - Mini	OPK05280	1
Anodized aluminium brackets 810 mm	OPK05020	1
Anodized aluminium brackets 290 mm - Extra midi	OPK05295	1
Anodized aluminium brackets 1070 mm - Midi	OPK05290	1
Anodized aluminium brackets 1241 mm - Maxi	OPK05260	1



Description	code	pcs
Lateral panel in PP with dovetail joints	OPK00040	1
Central panel with sliding guides for drawers	OPK00050	1
Cover dovetail joints in PP for lateral panel - left	OPASX800	1
Cover dovetail joints in PP for lateral panel - right	OPADX800	1
Back closing panel in ABS	OPKSX030	1
Back closing panel in ABS - single	OPKSX250	1
Door in ABS with key lock - left	OPKSX220	1
Door in ABS with key lock - right	OPKDX220	1
Single door with ABS key lock - left	OPKSX080	1
Single door with ABS key lock - right	OPKDX080	1
Cover for closing top in PP	OPA00610	1
Cover lid in PP	OPK0010A	1
Cover lid in PP with key	OPK0011A	1
Cover lid in PP with transparent document or Pad holder	OPK0021A	1

Description	code	pcs
 Full shelf 50x70 cm made of wood with metal blocking device - black	OPK00690	1
 Shelf in PP 32x50 cm	OPK00070	1
 7L bucket in PP		
orange handle	OPK0013A	1
red handle	OPK0013R	1
blue handle	OPK0013B	1
green handle	OPK0013G	1
yellow handle	OPK0013Y	1
 Tray 5Lt in PP 28x14x17h cm	OPK00080	1
 Pre-impregnation grid in PP 16x30cm for bucket 7L	OPA0202	1
 Pre-impregnation lid in PP 16x30cm for bucket 7L	OPA0203	1
 Tray with handles in PP 31x22xh12cm		
orange handles	S0202001	1
red handles	S0202001R	1
blue handles	S0202001B	1
 Tray without handles in PP 31x22xh12cm	S0202000	1
 Swivel tray support in grey painted metal 31x22 cm		
right	OPKDX86S	1
left	OPKSX86S	1
 Kit tray in PP 50x19xh16 cm complete with hooks	OPK00700	1
 Tray in PP 50x19xh16 cm	OPA00700	1
 Tray hooks (2pcs) complete with support and screws	OPK0071S	1
 Lid in PP for tray 50x19xh16 cm	OPA0204	1

Description	code	pcs
 10L drawer in PP 45x29xh8,5 cm	OPA00760	1
 20L drawer in PP 45x29xh16 cm	OPA00770	1
 40L drawer in PP 45x29xh33 cm	OPA00780	1
 Drawer support in ABS with stainless steel screw	OPA0070S	1
 Pre-impregnation grid in PP 32x49cm for drawers 20L and 40L	OPA0200	1
 Pre-impregnation lid in PP 32x49cm for drawers 20L and 40L	OPA0201	1
 22L disinfection bucket in PP	V13500	1
 Lid for 22L disinfection bucket	V13501	1
 Varnished metal support support for 22L bucket complete with 1 FixT - upper	OPA0C88S	1
 Varnished metal support support for 22L bucket - lower	OPA0089S	1



Description	code	pcs
PREXA S down press wringer with press bar in Delrin - without rubber inserts		
orange splash guards	S0100201	1
red splash guards	S0100201B	1
blue splash guards	S0100201R	1
Prexa I down press wringer, POM wringing bars, version with rubber inserts		
orange splash guards	S0100101	1
red splash guards	S0100101B	1
blue splash guards	S0100101R	1
Support for wringer in grey varnished metal ø20mm	OPK05270	1
15 L bucket in PP		
orange handle	S0201501	1
blue handle	S020150B	1
red handle	S0201502	1
Anodized aluminum pushing handle complete with supports in PP	OPK05110	1
Right and left coupling kit complete with plugs for Van Opera	OPK0090	1
FixT handle holder in ABS with non-slip rubber roller for pushing handle	OPK05130	1
FixT handle holder in ABS with non-slip rubber roller	OPA00820	1
Safety sign holder in ABS	OPA00990	1
Mop holder for base in polyethylene complete with screws	OPA00730	1
Frame holder with orange cover lid	OPK05140	1



Description	code	pcs
Roll holder in grey painted metal	OPK3120S	1
Mop holder in grey painted metal	OPK10300VR	1
Mop velcro closing belt	OPK10150I	1
Pedal lid opening complete with aluminium bar	OPK1200S	1
Plastic box with bottle holder	OPCS001	1
Divider 6 compartments for top - 47x28xh4 cm	OPA01900	1
Divider 6 compartments for drawers		
for drawers 10L - 43x28xh4 cm	OPA01700	1
for drawers 20L - 43x28xh13 cm	OPA01600	1
Holder for Hotel trolleys with 10 pockets - grey	OPA00900	1
Holder for Hotel trolleys 2x70L - grey	OPA00901	1



Description	code	pcs
Net for mop washing 35L		
blue stripes	TA0035B	10
yellow stripes	TA0035Y	10
red stripes	TA0035R	10
green stripes	TA0035G	10
Net for mop washing 120L	TA00120	10
SPRY GO	APDEW001	1
Plasticized bag 35L - grey	OPA00890	1
Plasticized bag 120L with frontal zip and logo TWT - grey	OPA00880	1
Plasticized bag 120L with lateral zip and logo TWT - grey	OPA00880.L	1
Vertical laundry bag 200L with frontal zip - grey	OPA00810	1
Laundry bag 260L with lid	OPA00850	1

OPERA ReUse

RECYCLED PLASTIC SERVICE AND CLEANING TROLLEYS



OPERA ReUse and ACCESSORIES



OP0100EN

Components included in the standard configuration	code	pcs
Base in PP ReUse with caps and 4 plates	OPK0002N	1
Cover dovetail joints in PP ReUse for base	OPABA80N	4
Wheel, metal, Ø 100mm	MO201RU3	4
Anodized aluminium brackets 810 mm	OPK05020	4
Half top in PP ReUse complete with caps and plates	OPK0524N	1
Fixing levels for bag 120 L (1pcs) - grey	OPA0066S	2
Bag anchoring kit 6pcs	OPK00120	1
Anodized aluminum pushing handle complete with supports in PP ReUse	OPK0511N	1
Swivel tray support in grey painted metal - left	OPASX86S	1
Swivel tray support in grey painted metal - right	OPADX86S	1
Tray in PP ReUse 31x22xh12cm - red handles	S0202001RN	2
Support for wringer in grey varnished metal ø20mm	OPK05270	1
Prexa wringer - black	S0100201NR	1
15L bucket in PP - red handle	S0201502N	1
15L bucket in PP - blue handle	S0201503N	1
Safety sign holder in ABS - black	OPA0099NX	1
FixT handle holder in ABS with non-slip rubber roller - black	OPA0082NX	1
OPTIONAL	code	pcs
Plasticized bag 120L with front zip and logo TWT - grey	OPA00880	1
Plasticized bag 120L with front zip and logo TWT - black	OPA0088N	1

Product dimensions 920x710xh1150 mm **Weight** 23 kg **Packaging** 1000x700xh500 mm **Volume** 0,350 mc



OP0400EN

Components included in the standard configuration	code	pcs
Base in PP ReUse with caps and 4 plates	OPK0002N	1
Cover dovetail joints in PP ReUse for base	OPABA80N	4
Wheel, metal, Ø 100mm	MO201RU3	4
Anodized aluminium brackets 810 mm	OPK05020	4
Half top in PP ReUse complete with caps and plates	OPK0524N	1
Fixing levels for bag 120 L (1pcs) - grey	OPA0066S	2
Bag anchoring kit 6pcs	OPK00120	1
Anodized aluminum pushing handle complete with supports in PP ReUse	OPK0511N	1
Support for wringer in grey varnished metal ø20mm	OPK05270	1
Prexa wringer - black	S0100201NR	1
15L bucket in PP - red handle	S0201502N	1
15L bucket in PP - blue handle	S0201503N	1
Safety sign holder in ABS - black	OPA0099NX	1
FixT handle holder in ABS with non-slip rubber roller - black	OPA0082NX	1
OPTIONAL	code	pcs
Plasticized bag 120L with front zip and logo TWT - grey	OPA00880	1
Plasticized bag 120L with front zip and logo TWT - black	OPA0088N	1

Product dimensions 920x710xh1030 mm **Weight** 20 kg **Packaging** 1000x700x500 mm **Volume** 0,350 mc



OP0500EN

Components included in the standard configuration		code	pcs
Base in PP ReUse with caps and 4 plates		OPK0002N	1
Cover dovetail joints in PP ReUse for base		OPABA80N	2
Cover dovetail joints in PP ReUse for lateral panel - right and left		OPADX80N OPASX80N	6
Wheel, metal, Ø 100mm		MO201RU3	4
Base for waste bag in PP ReUse complete with plug and caps		OPK0516N	1
Anodized aluminium brackets 810 mm		OPK05020	4
Back closing panel in ABS - black		OPKSX03NX	1
Lateral panel in PP ReUse with dovetail joints		OPK0004N	4
Left door in ABS with key lock - black		OPKSX22NX	1
Top full size in PP ReUse with caps and plates		OPK0506N	1
Fixing levels for bag 120 L (1pcs) - grey		OPA0066S	2
Bag anchoring kit 6pcs		OPK00120	1
Anodized aluminum pushing handle complete with supports in PP ReUse		OPK0511N	2
Cushioned cover lid in PP - black		OPK0010N	1
Cushioned cover lid in PP with transparent document or Pad holder - black		OPK0021NX	1
Shelf in PP ReUse 32x50 cm		OPK0007N	1
7L bucket in PP ReUse 30x16xh23 cm - red handle		OPK0013NR	1
7L bucket in PP ReUse 30x16xh23 cm - blue handle		OPK0013NB	1
7L bucket in PP ReUse 30x16xh23 cm - yellow handle		OPK0013NY	1
Support for wringer in grey varnished metal ø20mm		OPK05270	1
Prexa wringer - black		S0100201NR	1
15L bucket in PP - red handle		S0201502N	1
15L bucket in PP - blue handle		S0201503N	1
Safety sign holder in ABS - black		OPA0099NX	1
FixT handle holder in ABS with non-slip rubber roller - black		OPA0082NX	1
OPTIONAL		code	pcs
Plasticized bag 120L with front zip and logo TWT - grey		OPA00880	1
Plasticized bag 120L with front zip and logo TWT - black		OPA0088N	1

Product dimensions 1270x710xh1030 mm **Weight** 32 kg **Packaging** 1140x800x500 mm **Volume** 0,456 mc



OP0600EN

Components included in the standard configuration		code	pcs
Base in PP ReUse with caps and 4 plates		OPK0002N	1
Cover dovetail joints in PP ReUse for base		OPABA80N	2
Wheel, metal, Ø 100mm		MO201RU3	4
Base for waste bag in PP ReUse complete with plug and caps		OPK0516N	1
Anodized aluminium brackets 810 mm		OPK05020	4
Top full size in PP ReUse with caps and plates		OPK0506N	1
Fixing levels for bag 120 L (1pcs) - grey		OPA0066S	2
Bag anchoring kit 6pcs		OPK00120	1
Anodized aluminum pushing handle complete with supports in PP ReUse		OPK0511N	2
Shelf in PP ReUse 32x50 cm		OPK0007N	1
7L bucket in PP ReUse 30x16xh23 cm - red handle		OPK0013NR	1
7L bucket in PP ReUse 30x16xh23 cm - blue handle		OPK0013NB	1
10L drawer in PP ReUse 45x29xh8,5 cm		OPA0076N	1
Drawer support in ABS with stainless steel screw		OPA0070S	8
Support for wringer in grey varnished metal ø20mm		OPK05270	1
Prexa wringer - black		S0100201NR	1
15L bucket in PP - red handle		S0201502N	1
15L bucket in PP - blue handle		S0201503N	1
Safety sign holder in ABS - black		OPA0099NX	1
FixT handle holder in ABS with non-slip rubber roller - black		OPA0082NX	1
OPTIONAL		code	pcs
Plasticized bag 120L with front zip and logo TWT - grey		OPA00880	1
Plasticized bag 120L with front zip and logo TWT - black		OPA0088N	1

Product dimensions 1270x710xh1220 mm **Weight** 21 kg **Packaging** 1000x700xh500 mm **Volume** 0,350 mc



OP0700EN

Components included in the standard configuration	code	pcs
Base in PP ReUse with caps and 6 plates	OPK0003N	1
Cover dovetail joints in PP ReUse for base	OPABA80N	4
Wheel, metal, Ø 100mm	MO201RU3	4
Anodized aluminium brackets 810 mm	OPK05020	6
Top full size in PP ReUse with caps and plates	OPK0506N	1
Fixing levels for bag 120 L (1pcs) - grey	OPA0066S	2
Bag anchoring kit 6pcs	OPK00120	1
Anodized aluminum pushing handle complete with supports in PP ReUse	OPK0511N	2
Cushioned cover lid in PP - black	OPK0010N	1
10L drawer in PP ReUse 45x29xh8,5 cm	OPA0076N	1
Drawer support in ABS with stainless steel screw	OPA0070S	4
7L bucket in PP ReUse 30x16xh23 cm - red handle	OPK0013NR	1
7L bucket in PP ReUse 30x16xh23 cm - blue handle	OPK0013NB	1
7L bucket in PP ReUse 30x16xh23 cm - yellow handle	OPK0013NY	1
Safety sign holder in ABS - black	OPA0099NX	1
FixT handle holder in ABS with non-slip rubber roller - black	OPA0082NX	1
OPTIONAL		
Plasticized bag 120L with front zip and logo TWT - grey	OPA00880	1
Plasticized bag 120L with front zip and logo TWT - black	OPA0088N	1
Tray in PP ReUse 50x19xh16 cm complete with hooks	OPK00700N	2



OP0810EN

Components included in the standard configuration	code	pcs
Base in PP ReUse with caps and 4 plates	OPK0002N	1
Cover dovetail joints in PP ReUse for base	OPABA80N	2
Cover dovetail joints in PP ReUse for lateral panel - right and left	OPADX80N OPASX80N	6
Wheel, metal, Ø 100mm	MO201RU3	4
Base for waste bag in PP ReUse complete with plug and caps	OPK0516N	1
Anodized aluminium brackets 810 mm	OPK05020	4
Lateral panel in PP ReUse with dovetail joints	OPK0004N	4
Top full size in PP ReUse with caps and plates	OPK0506N	1
Fixing levels for bag 120 L (1pcs) - grey	OPA0066S	2
Bag anchoring kit 6pcs	OPK00120	1
Anodized aluminum pushing handle complete with supports in PP ReUse	OPK0511N	2
Shelf in PP ReUse 32x50 cm	OPK0007N	1
20L drawer in PP ReUse 45x29xh16 cm	OPA0077N	1
7L bucket in PP ReUse 30x16xh23 cm - red handle	OPK0013NR	1
7L bucket in PP ReUse 30x16xh23 cm - blue handle	OPK0013NB	1
7L bucket in PP ReUse 30x16xh23 cm - yellow handle	OPK0013NY	1
Safety sign holder in ABS - black	OPA0099NX	1
FixT handle holder in ABS with non-slip rubber roller - black	OPA0082NX	1
OPTIONAL		
Plasticized bag 120L with front zip and logo TWT - grey	OPA00880	1
Plasticized bag 120L with front zip and logo TWT - black	OPA0088N	1



OP0900EN

Components included in the standard configuration

Base in PP ReUse with caps and 4 plates	OPK0002N	1
Cover dovetail joints in PP ReUse for base	OPABA80N	4
Cover dovetail joints in PP ReUse for lateral panel - right and left	OPADX80N OPASX80N	6
Wheel, metal, Ø 100mm	MO201RU3	4
Anodized aluminium brackets 810 mm	OPK05020	4
Lateral panel in PP ReUse with dovetail joints	OPK0004N	4
Top full size in PP ReUse with caps and plates	OPK0506N	1
Fixing levels for bag 120 L (1pcs) - grey	OPA0066S	2
Bag anchoring kit 6pcs	OPK00120	1
Anodized aluminum pushing handle complete with supports in PP ReUse	OPK0511N	2
Cushioned cover lid in PP with transparent document or Pad holder - black	OPK0021NX	1
Shelf in PP ReUse 32x50 cm	OPK0007N	1
20L drawer in PP ReUse 45x29xh16 cm	OPA0077N	1
40L drawer in PP ReUse 45x29xh33 cm	OPA0078N	1
7L bucket in PP ReUse 30x16xh23 cm - red handle	OPK0013NR	1
7L bucket in PP ReUse 30x16xh23 cm - blue handle	OPK0013NB	1
7L bucket in PP ReUse 30x16xh23 cm - yellow handle	OPK0013NY	1
Safety sign holder in ABS - black	OPA0099NX	1
FixT handle holder in ABS with non-slip rubber roller - black	OPA0082NX	1

OPTIONAL

Plasticized bag 120L with front zip and logo TWT - grey	OPA00880	1
Plasticized bag 120L with front zip and logo TWT - black	OPA0088N	1

code	pcs
OPK0002N	1
OPABA80N	4
OPADX80N OPASX80N	6
MO201RU3	4
OPK05020	4
OPK0004N	4
OPK0506N	1
OPA0066S	2
OPK00120	1
OPK0511N	2
OPK0021NX	1
OPK0007N	1
OPA0077N	1
OPA0078N	1
OPK0013NR	1
OPK0013NB	1
OPK0013NY	1
OPA0099NX	1
OPA0082NX	1

code	pcs
OPA00880	1
OPA0088N	1





OP1100EN

Components included in the standard configuration

	code	pcs
Base in PP ReUse with caps and 4 plates	OPK0002N	1
Cover dovetail joints in PP ReUse for base	OPABA80N	2
Cover dovetail joints in PP ReUse for lateral panel - right and left	OPADX80N OPASX80N	6
Silent Wheel, plastic, Ø125mm	OPA00740	4
Bumpers ø155mm for wheels ø125 mm in PP - grey	OPA00320	4
Base for waste bag in PP ReUse complete with plug and caps	OPK0516N	1
Bag support 120L in PP complete with lateral support and bag locking rings	OPKC5155N	1
Anodized aluminium brackets 810 mm	OPK05020	4
Lateral panel in PP ReUse with dovetail joints	OPK0004N	4
Back closing panel in ABS - black	OPKSX03NX	1
Left door in ABS with key lock - black	OPKSX22NX	1
Half top in PP ReUse complete with caps and plates	OPK0524N	1
Cushioned cover lid in PP - black	OPK0010N	1
Cushioned cover lid in PP with transparent document or Pad holder - black	OPK0021NX	1
Shelf in PP ReUse 32x50 cm	OPK0007N	1
Support for wringer in grey varnished metal ø20mm	OPK05270	1
Prexa wringer - black	S0100201NR	1
15L bucket in PP - red handle	S0201502N	1
15L bucket in PP - blue handle	S0201503N	1
Safety sign holder in ABS - black	OPA0099NX	1
FixT handle holder in ABS with non-slip rubber roller - black	OPA0082NX	1

OPTIONAL

	code	pcs
Plasticized bag 120L with front zip and logo TWT - grey	OPA00880	1
Plasticized bag 120L with front zip and logo TWT - black	OPA0088N	1

Product dimensions 1410x710x1070 mm Weight 33,5kg Packaging 1140x800x500 mm Volume 0,456 mc



OP1300EN

Components included in the standard configuration

	code	pcs
Base in PP ReUse with caps and 4 plates	OPK0002N	1
Cover dovetail joints in PP ReUse for base	OPABA80N	2
Cover dovetail joints in PP ReUse for lateral panel - right and left	OPADX80N OPASX80N	6
Silent Wheel, plastic, Ø125mm	OPA00740	4
Bumpers ø155mm for wheels ø125 mm in PP - grey	OPA00320	4
Base for waste bag in PP ReUse complete with plug and caps	OPK0516N	1
Bag support 120L in PP complete with lateral support and bag locking rings	OPKC5155N	1
Anodized aluminium brackets 810 mm	OPK05020	4
Lateral panel in PP ReUse with dovetail joints	OPK0004N	4
Half top in PP ReUse complete with caps and plates	OPK0524N	1
Cushioned cover lid in PP - black	OPK0010N	1
Cushioned cover lid in PP with transparent document or Pad holder - black	OPK0021NX	1
Shelf in PP ReUse 32x50 cm	OPK0007N	1
20L drawer in PP ReUse 45x29xh16 cm	OPA0077N	1
40L drawer in PP ReUse 45x29xh33 cm	OPA0078N	1
7L bucket in PP ReUse 30x16xh23 cm - red handle	OPK0013NR	1
7L bucket in PP ReUse 30x16xh23 cm - blue handle	OPK0013NB	1
7L bucket in PP ReUse 30x16xh23 cm - yellow handle	OPK0013NY	1
Support for wringer in grey varnished metal ø20mm	OPK05270	1
Prexa wringer - black	S0100201NR	1
15L bucket in PP - red handle	S0201502N	1
15L bucket in PP - blue handle	S0201503N	1
Safety sign holder in ABS - black	OPA0099NX	1
FixT handle holder in ABS with non-slip rubber roller - black	OPA0082NX	1

OPTIONAL

	code	pcs
Plasticized bag 120L with front zip and logo TWT - grey	OPA00880	1
Plasticized bag 120L with front zip and logo TWT - black	OPA0088N	1

Product dimensions 1410x710x1070 mm Weight 37 kg Packaging 1140x800x500 mm Volume 0,456 mc



OP2100EN

Components included in the standard configuration	code	pcs
Base in PP ReUse with caps and 4 plates	OPK0002N	1
Cover dovetail joints in PP ReUse for base	OPABA80N	4
Cover dovetail joints in PP ReUse for lateral panel - right and left	OPADX80N OPASX80N	8
Silent Wheel, plastic, Ø125mm	OPA00740	4
Bumpers ø155mm for wheels ø125 mm in PP - grey	OPA00320	4
Anodized aluminium brackets 810 mm	OPK05020	4
Lateral panel in PP ReUse with dovetail joints	OPK0004N	4
Back closing panel in ABS - black	OPKSX03NX	1
Left door in ABS with key lock - black	OPKSX22NX	1
Half top in PP ReUse complete with caps and plates	OPK0524N	1
Fixing levels for bag 120 L (1pcs) - grey	OPA0066S	2
Bag anchoring kit 6pcs	OPK00120	1
Anodized aluminum pushing handle complete with supports in PP ReUse	OPK0511N	1
Cushioned cover lid in PP - black	OPK0010N	1
Support for wringer in grey varnished metal ø20mm	OPK05270	1
Prexa wringer - black	S0100201NR	1
15L bucket in PP - red handle	S0201502N	1
15L bucket in PP - blue handle	S0201503N	1
Safety sign holder in ABS - black	OPA0099NX	1
FixT handle holder in ABS with non-slip rubber roller - black	OPA0082NX	1

Product dimensions 940x710xh1070 mm **Weight** 29 kg **Packaging** 1000x700xh500 mm **Volume** 0,350 mc



OP2200EN

Components included in the standard configuration	code	pcs
Base in PP ReUse with caps and 4 plates	OPK0002N	1
Cover dovetail joints in PP ReUse for base	OPABA80N	4
Cover dovetail joints in PP ReUse for lateral panel - right and left	OPADX80N OPASX80N	8
Silent Wheel, plastic, Ø125mm	OPA00740	4
Bumpers ø155mm for wheels ø125 mm in PP - grey	OPA00320	4
Anodized aluminium brackets 810 mm	OPK05020	4
Lateral panel in PP ReUse with dovetail joints	OPK0004N	4
Half top in PP ReUse complete with caps and plates	OPK0524N	1
Anodized aluminum pushing handle complete with supports in PP ReUse	OPK0511N	1
Cushioned cover lid in PP - black	OPK0010N	1
Shelf in PP ReUse 32x50 cm	OPK0007N	1
20L drawer in PP ReUse 45x29xh16 cm	OPA0077N	1
40L drawer in PP ReUse 45x29xh33 cm	OPA0078N	1
7L bucket in PP ReUse 30x16xh23 cm - red handle	OPK0013NR	1
7L bucket in PP ReUse 30x16xh23 cm - blue handle	OPK0013NB	1
7L bucket in PP ReUse 30x16xh23 cm - yellow handle	OPK0013NY	1
Support for wringer in grey varnished metal ø20mm	OPK05270	1
Prexa wringer - black	S0100201NR	1
15L bucket in PP - red handle	S0201502N	1
15L bucket in PP - blue handle	S0201503N	1
Safety sign holder in ABS - black	OPA0099NX	1
FixT handle holder in ABS with non-slip rubber roller - black	OPA0082NX	1

Product dimensions 940x710xh1070 mm **Weight** 34 kg **Packaging** 1140x800xh500 mm **Volume** 0,456 mc



OP3100EN

Components included in the standard configuration	code	pcs
Base in PP ReUse with caps and 6 plates	OPK0003N	1
Cover dovetail joints in PP ReUse for base	OPABA80N	4
Cover dovetail joints in PP ReUse for lateral panel - right and left	OPADX80N OPASX80N	8
Silent Wheel, plastic, Ø125mm	OPA00740	4
Bumpers ø155mm for wheels ø125 mm in PP - grey	OPA00320	4
Anodized aluminium brackets 810 mm	OPK05020	6
Lateral panel in PP ReUse with dovetail joints	OPK0004N	4
Central panel with sliding guides for drawers - black	OPK0005NX	2
Back closing panel in ABS - black	OPKSX03NX	2
Right door in ABS with key lock - black	OPKDX22NX	1
Left door in ABS with key lock - black	OPKSX22NX	1
Top full size in PP ReUse with caps and plates	OPK0506N	1
Anodized aluminum pushing handle complete with supports in PP ReUse	OPK0511N	2
Cushioned cover lid in PP - black	OPK0010N	2
Shelf in PP ReUse 32x50 cm	OPK0007N	2
Safety sign holder in ABS - black	OPA0099NX	1
FixT handle holder in ABS with non-slip rubber roller - black	OPA0082NX	1

Product dimensions 990x620xh1070 mm **Weight** 29 kg **Packaging** 1140x800xh500 mm **Volume** 0,456 mc



OP3200EN

Components included in the standard configuration	code	pcs
Base in PP ReUse with caps and 6 plates	OPK0003N	1
Cover dovetail joints in PP ReUse for base	OPABA80N	4
Cover dovetail joints in PP ReUse for lateral panel - right and left	OPADX80N OPASX80N	8
Silent Wheel, plastic, Ø125mm	OPA00740	4
Bumpers ø155mm for wheels ø125 mm in PP - grey	OPA00320	4
Anodized aluminium brackets 810 mm	OPK05020	6
Lateral panel in PP ReUse with dovetail joints	OPK0004N	4
Central panel with sliding guides for drawers - black	OPK0005NX	2
Back closing panel in ABS - black	OPKSX03NX	2
Right door in ABS with key lock - black	OPKDX22NX	1
Left door in ABS with key lock - black	OPKSX22NX	1
Top full size in PP ReUse with caps and plates	OPK0506N	1
Anodized aluminum pushing handle complete with supports in PP ReUse	OPK0511N	2
Cushioned cover lid in PP - black	OPK0010N	2
40L drawer in PP ReUse 45x29xh33 cm	OPA0078N	4
Safety sign holder in ABS - black	OPA0099NX	1
FixT handle holder in ABS with non-slip rubber roller - black	OPA0082NX	1

Product dimensions 990x620xh1070 mm **Weight** 33 kg **Packaging** 1140x800xh500 mm **Volume** 0,456 mc



OP4100EN

Components included in the standard configuration

	code	pcs
Base in PP ReUse with caps and 6 plates	OPK0003N	1
Cover dovetail joints in PP ReUse for base	OPABA80N	2
Cover dovetail joints in PP ReUse for lateral panel - right and left	OPADX80N OPASX80N	6
Silent Wheel, plastic, Ø125mm	OPA00740	4
Bumpers ø155mm for wheels ø125 mm in PP - grey	OPA00320	4
Base for waste bag in PP ReUse complete with plug and caps	OPK0516N	1
Bag support 120L in PP complete with lateral support and bag locking rings	OPKC5155N	1
Anodized aluminium brackets 810 mm	OPK05020	6
Lateral panel in PP ReUse with dovetail joints	OPK0004N	4
Central panel with sliding guides for drawers - black	OPK0005NX	2
Back closing panel in ABS - black	OPKSX03NX	2
Right door in ABS with key lock - black	OPKDX22NX	1
Left door in ABS with key lock - black	OPKSX22NX	1
Top full size in PP ReUse with caps and plates	OPK0506N	1
Anodized aluminum pushing handle complete with supports in PP ReUse	OPK0511N	1
Cushioned cover lid in PP - black	OPK0010N	2
Cushioned cover lid in PP with transparent document or Pad holder - black	OPK0021NX	1
Shelf in PP ReUse 32x50 cm	OPK0007N	2
Safety sign holder in ABS - black	OPA0099NX	1
FixT handle holder in ABS with non-slip rubber roller - black	OPA0082NX	1

OPTIONAL

Plasticized bag 120L with front zip and logo TWT - grey
Plasticized bag 120L with front zip and logo TWT - black

code	pcs
OPA00880	1
OPA0088N	1



OP4200EN

Components included in the standard configuration

	code	pcs
Base in PP ReUse with caps and 6 plates	OPK0003N	1
Cover dovetail joints in PP ReUse for base	OPABA80N	2
Cover dovetail joints in PP ReUse for lateral panel - right and left	OPADX80N OPASX80N	6
Silent Wheel, plastic, Ø125mm	OPA00740	4
Bumpers ø155mm for wheels ø125 mm in PP - grey	OPA00320	4
Base for waste bag in PP ReUse complete with plug and caps	OPK0516N	1
Bag support 120L in PP complete with lateral support and bag locking rings	OPKC5155N	1
Anodized aluminium brackets 810 mm	OPK05020	6
Lateral panel in PP ReUse with dovetail joints	OPK0004N	4
Central panel with sliding guides for drawers - black	OPK0005NX	2
Back closing panel in ABS - black	OPKSX03NX	2
Right door in ABS with key lock - black	OPKDX22NX	1
Left door in ABS with key lock - black	OPKSX22NX	1
Top full size in PP ReUse with caps and plates	OPK0506N	1
Anodized aluminum pushing handle complete with supports in PP ReUse	OPK0511N	1
Cushioned cover lid in PP - black	OPK0010N	2
Cushioned cover lid in PP with transparent document or Pad holder - black	OPK0021NX	1
Shelf in PP ReUse 32x50 cm	OPK0007N	3
20L drawer in PP ReUse 45x29xh16 cm	OPA0077N	2
40L drawer in PP ReUse 45x29xh33 cm	OPA0078N	1
7L bucket in PP ReUse 30x16xh23 cm - red handle	OPK0013NR	1
7L bucket in PP ReUse 30x16xh23 cm - blue handle	OPK0013NB	1
7L bucket in PP ReUse 30x16xh23 cm - yellow handle	OPK0013NY	1
Safety sign holder in ABS - black	OPA0099NX	1
FixT handle holder in ABS with non-slip rubber roller - black	OPA0082NX	1

OPTIONAL

Plasticized bag 120L with front zip and logo TWT - grey
Plasticized bag 120L with front zip and logo TWT - black

code	pcs
OPA00880	1
OPA0088N	1

OPERA 5.1 R MULTIPURPOSE TROLLEY

OP5100EN



OP5100EN

Components included in the standard configuration		code	pcs
Base in PP ReUse with caps and 6 plates		OPK0003N	1
Cover dovetail joints in PP ReUse for lateral panel - right and left		OPADX80N OPASX80N	4
Silent Wheel, plastic, Ø125mm		OPA00740	4
Bumpers ø155mm for wheels ø125 mm in PP - grey		OPA00320	4
Base for waste bag in PP ReUse complete with plug and caps		OPK0516N	2
Bag support 120L in PP complete with lateral support and bag locking rings		OPKC5155N	2
Anodized aluminium brackets 810 mm		OPK05020	6
Lateral panel in PP ReUse with dovetail joints		OPK0004N	4
Central panel with sliding guides for drawers - black		OPK0005NX	2
Back closing panel in ABS - black		OPKSX03NX	2
Right door in ABS with key lock - black		OPKDX22NX	1
Left door in ABS with key lock - black		OPKSX22NX	1
Top full size in PP ReUse with caps and plates		OPK0506N	1
Cushioned cover lid in PP - black		OPK0010N	3
Cushioned cover lid in PP with trasparente document or Pad holder - black		OPK0021NX	1
Shelf in PP ReUse 32x50 cm		OPK0007N	2
Safety sign holder in ABS - black		OPA0099NX	1
FixT handle holder in ABS with non-slip rubber roller - black		OPA0082NX	1
OPTIONAL		code	pcs
Plasticized bag 120L with front zip and logo TWT - grey		OPA00880	2
Plasticized bag 120L with front zip and logo TWT - black		OPA0088N	2
Pedal for lid opening complete with aluminium bar		OPK12005	2
Silent Wheel, plastic, Ø 80mm		S020180G	2

Product dimensions 1940x620xh1070 mm **Weight** 35 kg **Packaging** 1140x800xh500 mm **Volume** 0,456 mc

OPERA 5.2 R MULTIPURPOSE TROLLEY

OP5200EN



OP5200EN

Components included in the standard configuration		code	pcs
Base in PP ReUse with caps and 6 plates		OPK0003N	1
Cover dovetail joints in PP ReUse for lateral panel - right and left		OPADX80N OPASX80N	4
Silent Wheel, plastic, Ø125mm		OPA00740	4
Bumpers ø155mm for wheels ø125 mm in PP - grey		OPA00320	4
Base for waste bag in PP ReUse complete with plug and caps		OPK0516N	2
Bag support 120L in PP complete with lateral support and bag locking rings		OPKC5155N	2
Anodized aluminium brackets 810 mm		OPK05020	6
Lateral panel in PP ReUse with dovetail joints		OPK0004N	4
Central panel with sliding guides for drawers - black		OPK0005NX	2
Back closing panel in ABS - black		OPKSX03NX	2
Right door in ABS with key lock - black		OPKDX22NX	1
Left door in ABS with key lock - black		OPKSX22NX	1
Top full size in PP ReUse with caps and plates		OPK0506N	1
Cushioned cover lid in PP - black		OPK0010N	3
Cushioned cover lid in PP with trasparente document or Pad holder - black		OPK0021NX	1
Shelf in PP ReUse 32x50 cm		OPK0007N	3
20L drawer in PP ReUse 45x29xh16 cm		OPA0077N	2
40L drawer in PP ReUse 45x29xh33 cm		OPA0078N	1
7L bucket in PP ReUse 30x16xh23 cm - red handle		OPK0013NR	1
7L bucket in PP ReUse 30x16xh23 cm - blue handle		OPK0013NB	1
7L bucket in PP ReUse 30x16xh23 cm - yellow handle		OPK0013NY	1
Safety sign holder in ABS - black		OPA0099NX	1
FixT handle holder in ABS with non-slip rubber roller - black		OPA0082NX	1
OPTIONAL		code	pcs
Plasticized bag 120L with front zip and logo TWT - grey		OPA00880	2
Plasticized bag 120L with front zip and logo TWT - black		OPA0088N	2
Pedal for lid opening complete with aluminium bar		OPK12005	2
Silent Wheel, plastic, Ø 80mm		S020180G	2

Product dimensions 1940x620xh1070 mm **Weight** 41,2 kg **Packaging** 1070x700xh1090 mm **Volume** 0,810 mc

OPERA 5.3 R HOTEL

OP5300EN



OP5300EN

Components included in the standard configuration	code	pcs
Base in PP ReUse with caps and 6 plates	OPK0003N	1
Cover dovetail joints in PP ReUse for base	OPABA80N	2
Cover dovetail joints in PP ReUse for lateral panel - right and left	OPADX80N OPASX80N	6
Silent Wheel, plastic, Ø125mm	OPA00740	4
Bumpers ø155mm for wheels ø125 mm in PP - grey	OPA00320	4
Base for waste bag in PP ReUse complete with plug and caps	OPK0516N	1
Bag support 120L in PP complete with lateral support and bag locking rings	OPKC5155N	1
Anodized aluminium brackets 810 mm	OPK05020	5
Lateral panel in PP ReUse with dovetail joints	OPK0004N	4
Back closing panel in ABS - black	OPKSX03NX	2
Right door in ABS with key lock - black	OPKDX22NX	1
Left door in ABS with key lock - black	OPKSX22NX	1
Top full size in PP ReUse with caps and plates	OPK0506N	1
Anodized aluminum pushing handle complete with supports in PP ReUse	OPK0511N	1
Cover for closing top in PP - black	OPA0061N	2
Cushioned cover lid in PP with transparent document or Pad holder - black	OPK0021NX	1
Full shelf 50x70 cm made of wood with metal blocking device - black	OPK00690	1
Safety sign holder in ABS - black	OPA0099NX	1
FixT handle holder in ABS with non-slip rubber roller - black	OPA0082NX	1

OPTIONAL

	code	pcs
Plasticized bag 120L with front zip and logo TWT - grey	OPA00880	1
Plasticized bag 120L with front zip and logo TWT - black	OPA0088N	1

Product dimensions 1440x620xh1070 mm Weight 53 kg Packaging 1140x800xh500 mm Volume 0,456 mc

OPERA 5.4 R HOTEL

OP5400EN



OP5400EN

Components included in the standard configuration	code	pcs
Base in PP ReUse with caps and 6 plates	OPK0003N	1
Cover dovetail joints in PP ReUse for lateral panel - right and left	OPADX80N OPASX80N	4
Silent Wheel, plastic, Ø125mm	OPA00740	4
Bumpers ø155mm for wheels ø125 mm in PP - grey	OPA00320	4
Base for waste bag in PP ReUse complete with plug and caps	OPK0516N	2
Bag support 120L in PP complete with lateral support and bag locking rings	OPKC5155N	2
Anodized aluminium brackets 810 mm	OPK05020	6
Lateral panel in PP ReUse with dovetail joints	OPK0004N	4
Central panel with sliding guides for drawers - black	OPK0005NX	2
Back closing panel in ABS - black	OPKSX03NX	2
Right door in ABS with key lock - black	OPKDX22NX	1
Left door in ABS with key lock - black	OPKSX22NX	1
Top full size in PP ReUse with caps and plates	OPK0506N	1
Cover for closing top in PP - black	OPA0061N	2
Cushioned cover lid in PP - black	OPK0010N	1
Cushioned cover lid in PP with transparent document or Pad holder - black	OPK0021NX	1
Shelf in PP ReUse 32x50 cm	OPK0007N	2
10L drawer in PP ReUse 45x29xh8,5 cm	OPA0076N	1
Safety sign holder in ABS - black	OPA0099NX	1
FixT handle holder in ABS with non-slip rubber roller - black	OPA0082NX	1

OPTIONAL

	code	pcs
Plasticized bag 120L with front zip and logo TWT - grey	OPA00880	2
Plasticized bag 120L with front zip and logo TWT - black	OPA0088N	2

Product dimensions 1940x620xh1070 mm Weight 40 kg Packaging 1140x800xh500 mm Volume 0,456 mc

OPERA 6.2 R HOTEL

OP6200EN



OP6200EN

Components included in the standard configuration	code	pcs
Base in PP ReUse with caps and 4 plates	OPK0002N	1
Cover dovetail joints in PP ReUse for base	OPABA80N	2
Cover dovetail joints in PP ReUse for lateral panel - right and left	OPADX80N OPASX80N	10
Silent Wheel, plastic, Ø125mm	OPA00740	4
Bumpers ø155mm for wheels ø125 mm in PP - grey	OPA00320	4
Base for waste bag in PP ReUse complete with plug and caps	OPK0516N	1
Bag support 120L in PP complete with lateral support and bag locking rings	OPKC5155N	1
Anodized aluminium brackets 1241 mm - Maxi	OPK05260	4
Back closing panel in ABS single - black	OPKSX25NX	1
Back closing panel in ABS - black	OPKSX03NX	1
Lateral panel in PP ReUse with dovetail joints	OPK0004N	6
Left single door with ABS key lock - black	OPKSX08NX	1
Half top in PP ReUse complete with caps and plates	OPK0524N	1
Half top in PP ReUse with hole	OPK0543N	1
Anodized aluminum pushing handle complete with supports in PP ReUse	OPK0511N	1
Cover for closing top in PP - black	OPA0061N	2
Cushioned cover lid in PP with transparent document or Pad holder - black	OPK0021NX	1
Shelf in PP ReUse 32x50 cm	OPK0007N	1
20L drawer in PP ReUse 45x29xh16 cm	OPA0077N	1
Safety sign holder in ABS - black	OPA0099NX	1
FixT handle holder in ABS with non-slip rubber roller - black	OPA0082NX	1
OPTIONAL	code	pcs
Plasticized bag 120L with front zip and logo TWT - grey	OPA00880	1
Plasticized bag 120L with front zip and logo TWT - black	OPA0088N	1
Pedal for lid opening complete with aluminium bar	OPK1200S	1
Silent Wheel, plastic, Ø 80mm	S020180G	1

Product dimensions 1410x620xh1480 mm Weight 38 kg Packaging 1140x800xh500 mm Volume 0,456 mc

OPERA 6.3 R HOTEL

OP6300EN



OP6300EN

Components included in the standard configuration	code	pcs
Base in PP ReUse with caps and 4 plates	OPK0002N	1
Cover dovetail joints in PP ReUse for base	OPABA80N	4
Cover dovetail joints in PP ReUse for lateral panel - right and left	OPADX80N OPASX80N	10
Silent Wheel, plastic, Ø125mm	OPA00740	4
Bumpers ø155mm for wheels ø125 mm in PP - grey	OPA00320	4
Anodized aluminium brackets 1241 mm - Maxi	OPK05260	4
Back closing panel in ABS single - black	OPKSX25NX	1
Back closing panel in ABS - black	OPKSX03NX	1
Lateral panel in PP ReUse with dovetail joints	OPK0004N	6
Half top in PP ReUse complete with caps and plates	OPK0524N	1
Top full size in PP ReUse with hole	OPK0542N	1
Fixing levels for bag 120 L (1pcs) - grey	OPA0066S	2
Bag anchoring kit 6pcs	OPK00120	1
Anodized aluminum pushing handle complete with supports in PP ReUse	OPK0511N	3
Cover for closing top in PP - black	OPA0061N	2
Shelf in PP ReUse 32x50 cm	OPK0007N	1
20L drawer in PP ReUse 45x29xh16 cm	OPA0077N	1
Safety sign holder in ABS - black	OPA0099NX	1
FixT handle holder in ABS with non-slip rubber roller - black	OPA0082NX	1
OPTIONAL	code	pcs
Plasticized bag 120L with front zip and logo TWT - grey	OPA00880	1
Plasticized bag 120L with front zip and logo TWT - black	OPA0088N	1

Product dimensions 990x620xh1480 mm Weight 30 kg Packaging 1140x800x500 mm Volume 0,456 mc

OPERA 7.1 R HOTEL

OP7100EN



OP7100EN

Components included in the standard configuration	code	pcs
Base in PP ReUse with caps and 6 plates	OPK0003N	1
Cover dovetail joints in PP ReUse for lateral panel - right and left	OPADX80N OPASX80N	8
Silent Wheel, plastic, Ø125mm	OPA00740	4
Bumpers ø155mm for wheels ø125 mm in PP - grey	OPA00320	4
Base for waste bag in PP ReUse complete with plug and caps	OPK0516N	2
Bag support 120L in PP complete with lateral support and bag locking rings	OPKC5155N	2
Anodized aluminium brackets 1241 mm - Maxi	OPK05260	6
Lateral panel in PP ReUse with dovetail joints	OPK0004N	6
Central panel with sliding guides for drawers - black	OPK0005NX	3
Back closing panel in ABS single - black	OPKSX25NX	2
Back closing panel in ABS - black	OPKSX03NX	2
Right single door with ABS key lock - black	OPKDX08NX	1
Left single door with ABS key lock - black	OPKSX08NX	1
Right door in ABS with key lock - black	OPKDX22NX	1
Left door in ABS with key lock - black	OPKSX22NX	1
Top full size in PP ReUse with caps and plates	OPK0506N	1
Top full size in PP ReUse with hole	OPK0542N	1
Anodized aluminum pushing handle complete with supports in PP ReUse	OPK0511N	2
Cover for closing top in PP - black	OPA0061N	4
Cushioned cover lid in PP - black	OPK0010N	1
Cushioned cover lid in PP with transparent document or Pad holder - black	OPK0021NX	1
Shelf in PP ReUse 32x50 cm	OPK0007N	2
20L drawer in PP ReUse 45x29xh16 cm	OPA0077N	2
Safety sign holder in ABS - black	OPA0099NX	1
FixT handle holder in ABS with non-slip rubber roller - black	OPA0082NX	1
OPTIONAL	code	pcs
Plasticized bag 120L with front zip and logo TWT - grey	OPA00880	2
Plasticized bag 120L with front zip and logo TWT - black	OPA0088N	2
Pedal for lid opening complete with aluminium bar	OPK12005	2
Silent Wheel, plastic, Ø 80mm	S020180G	2

Product dimensions 1940x620xh1480 mm Weight 57 kg Packaging 1140x800x500 mm Volume 0,456 mc

OPERA 7.2 R HOTEL

OP7200EN



OP7200EN

Components included in the standard configuration	code	pcs
Base in PP ReUse with caps and 6 plates	OPK0003N	1
Cover dovetail joints in PP ReUse for lateral panel - right and left	OPADX80N OPASX80N	8
Silent Wheel, plastic, Ø125mm	OPA00740	4
Bumpers ø155mm for wheels ø125 mm in PP - grey	OPA00320	4
Base for waste bag in PP ReUse complete with plug and caps	OPK0516N	2
Bag support 120L in PP complete with lateral support and bag locking rings	OPKC5155N	2
Anodized aluminium brackets 1241 mm - Maxi	OPK05260	5
Anodized aluminium brackets 450 mm - Mini	OPK05280	1
Lateral panel in PP ReUse with dovetail joints	OPK0004N	6
Central panel with sliding guides for drawers - black	OPK0005NX	1
Back closing panel in ABS single - black	OPKSX25NX	2
Back closing panel in ABS - black	OPKSX03NX	2
Top full size in PP ReUse with caps and plates	OPK0506N	1
Top full size in PP ReUse with hole	OPK0542N	1
Anodized aluminum pushing handle complete with supports in PP ReUse	OPK0511N	2
Cover for closing top in PP - black	OPA0061N	4
Full shelf 50x70 cm made of wood with metal blocking device - black	OPK00690	1
20L drawer in PP ReUse 45x29xh16 cm	OPA0077N	2
Safety sign holder in ABS - black	OPA0099NX	1
FixT handle holder in ABS with non-slip rubber roller - black	OPA0082NX	1
OPTIONAL	code	pcs
Plasticized bag 120L with front zip and logo TWT - grey	OPA00880	2
Plasticized bag 120L with front zip and logo TWT - black	OPA0088N	2
Silent Wheel, plastic, Ø 80mm	S020180G	2

Product dimensions 1940x620xh1480 mm Weight 49 kg Packaging 1140x800x500 mm Volume 0,456 mc

OPERA 8.4 R HOTEL

OP8400EN



OP8400EN

Components included in the standard configuration

Base in PP ReUse with caps and 6 plates
Cover dovetail joints in PP ReUse for base
Cover dovetail joints in PP ReUse for lateral panel - right and left
Silent Wheel, plastic, Ø125mm
Bumpers ø155mm for wheels ø125 mm in PP - grey
Base for waste bag in PP ReUse complete with plug and caps
Bag support 120L in PP complete with lateral support and bag locking rings
Anodized aluminium brackets 1241 mm - Maxi
Lateral panel in PP ReUse with dovetail joints
Central panel with sliding guides for drawers - black
Back closing panel in ABS single - black
Back closing panel in ABS - black
Right single door with ABS key lock - black
Left single door with ABS key lock - black
Right door in ABS with key lock - black
Left door in ABS with key lock - black
Top full size in PP ReUse with caps and plates
Top full size in PP ReUse with hole
Anodized aluminum pushing handle complete with supports in PP ReUse
Cover for closing top in PP - black
Cushioned cover lid in PP with transparent document or Pad holder - black
Shelf in PP ReUse 32x50 cm
20L drawer in PP ReUse 45x29xh16 cm
Safety sign holder in ABS - black
FixT handle holder in ABS with non-slip rubber roller - black

OPTIONAL

Plasticized bag 120L with front zip and logo TWT - grey
Plasticized bag 120L with front zip and logo TWT - black
Holder for Hotel trolleys with 10 pockets - grey

code	pcs
OPK0003N	1
OPABA80N	2
OPADX80N	10
OPASX80N	10
OPA00740	4
OPA00320	4
OPK0516N	1
OPKC5155N	1
OPK05260	6
OPK0004N	6
OPK0005NX	3
OPKSX25NX	2
OPKSX03NX	2
OPKDX08NX	1
OPKSX08NX	1
OPKDX22NX	1
OPKSX22NX	1
OPK0506N	1
OPK0542N	1
OPK0511N	3
OPA0061N	4
OPK0021NX	1
OPK0007N	2
OPA0077N	1
OPA0099NX	1
OPA0082NX	1
code	pcs
OPA00880	1
OPA0088N	1
OPA00900	1

Product dimensions 1460x620xh1480 mm Weight 52 kg Packaging 1140x800x500 mm Volume 0,456 mc

OPERA 8.5 R MIDI HOTEL

OP8500EN



OP8500EN

Components included in the standard configuration

Base in PP ReUse with caps and 6 plates
Cover dovetail joints in PP ReUse for base
Cover dovetail joints in PP ReUse for lateral panel - right and left
Silent Wheel, plastic, Ø125mm
Bumpers ø155mm for wheels ø125 mm in PP - grey
Base for waste bag in PP ReUse complete with plug and caps
Bag support 120L in PP complete with lateral support and bag locking rings
Anodized aluminium brackets 1070 mm - Midi
Anodized aluminium brackets 290 mm - Extra midi
Lateral panel in PP ReUse with dovetail joints
Lateral panel MIDI in PP ReUse with dovetail joints
Central panel MIDI with sliding guides for drawers - black
Back closing panel in ABS - black
Right door in ABS with key lock - black
Left door in ABS with key lock - black
Top full size in PP ReUse with caps and plates
Top full size in PP ReUse with hole
Anodized aluminum pushing handle complete with supports in PP ReUse
Cover for closing top in PP - black
Cushioned cover lid in PP - black
Cushioned cover lid in PP with transparent document or Pad holder - black
Full shelf 50x70 cm made of wood with metal blocking device - black
Shelf in PP ReUse 32x50 cm
20L drawer in PP ReUse 45x29xh16 cm
Safety sign holder in ABS - black
FixT handle holder in ABS with non-slip rubber roller - black

OPTIONAL

Plasticized bag 120L with front zip and logo TWT - grey
Plasticized bag 120L with front zip and logo TWT - black
Silent Wheel, plastic, Ø 80mm

code	pcs
OPK0003N	1
OPABA80N	2
OPADX80N	10
OPASX80N	10
OPA00740	4
OPA00320	4
OPK0516N	1
OPKC5155N	1
OPK05290	5
OPK05295	1
OPK0004N	4
OPK0004N.T	2
OPK0005N.T	1
OPKSX03NX	2
OPKDX22NX	1
OPKSX22NX	1
OPK0506N	1
OPK0542N	1
OPK0511N	3
OPA0061N	2
OPK0010N	2
OPK0021NX	1
OPK00690	1
OPK0007N	2
OPA0077N	2
OPA0099NX	1
OPA0082NX	1
code	pcs
OPA00880	1
OPA0088N	1
S020180G	1

Product dimensions 1440x620xh1310 mm Weight 52 kg Packaging 1070x700x1090 mm Volume 0,816 mc



OP1010EN

Components included in the standard configuration

Base in PP ReUse with caps and 6 plates
Cover dovetail joints in PP ReUse for base
Wheel, metal, Ø 100mm
Anodized aluminium brackets 810 mm
Top full size in PP ReUse with caps and plates
Fixing levels for bag 120 L (1pcs) - grey
Bag anchoring kit 6pcs
Anodized aluminum pushing handle complete with supports in PP ReUse
Safety sign holder in ABS - black
FixT handle holder in ABS with non-slip rubber roller - black

code	pcs
OPK0003N	1
OPABA80N	4
MO201RU3	4
OPK05020	4
OPK0506N	1
OPA0066S	4
OPK00120	2
OPK0511N	2
OPA0099NX	1
OPA0082NX	1

OPTIONAL

Plasticized bag 120L with front zip and logo TWT - grey
Plasticized bag 120L with front zip and logo TWT - black

code	pcs
OPA00880	2
OPA0088N	2



OP1020EN

Components included in the standard configuration

Base in PP ReUse with caps and 4 plates
Cover dovetail joints in PP ReUse for base
Cover dovetail joints in PP ReUse for lateral panel - right and left
Wheel, metal, Ø 100mm
Anodized aluminium brackets 810 mm
Lateral panel in PP ReUse with dovetail joints
Top full size in PP ReUse with caps and plates
Fixing levels for bag 120 L (1pcs) - grey
Bag anchoring kit 6pcs
Anodized aluminum pushing handle complete with supports in PP ReUse
Shelf in PP ReUse 32x50 cm
20L drawer in PP ReUse 45x29xh16 cm
Safety sign holder in ABS - black
FixT handle holder in ABS with non-slip rubber roller - black

code	pcs
OPK0002N	1
OPABA80N	4
OPADX80N	8
OPASX80N	8
MO201RU3	4
OPK05020	4
OPK0004N	4
OPK0506N	1
OPA0066S	2
OPK00120	1
OPK0511N	2
OPK0007N	1
OPA0077N	1
OPA0099NX	1
OPA0082NX	1

OPTIONAL

Plasticized bag 120L with front zip and logo TWT - grey
Plasticized bag 120L with front zip and logo TWT - black

code	pcs
OPA00880	1
OPA0088N	1



OP1050EN

Components included in the standard configuration

	code	pcs
Base in PP ReUse with caps and 6 plates	OPK0003N	1
Cover dovetail joints in PP ReUse for base	OPABA80N	4
Wheel, metal, Ø 100mm	MO201RU3	4
Anodized aluminium brackets 810 mm	OPK05020	4
Bag holder ring in painted metal	OPA0095S	1
Laudry bag 260L with hinge - black	OPA00850N	1



OP2400EN

Components included in the standard configuration

	code	pcs
Compact base in PP ReUse with 4 plates	OPK00C11N	1
Cover dovetail joints in PP ReUse for base	OPABA80N	4
Silent Wheel, plastic, Ø125mm	OPA00740	4
Bumpers ø155mm for wheels ø125 mm in PP - grey	OPA00320	4
Anodized aluminium brackets 1241 mm - Maxi	OPK05260	4
Half top in PP ReUse complete with caps and plates	OPK0524N	1
Anodized aluminum pushing handle complete with supports in PP ReUse	OPK0511N	1
Vertical laundry bag 200L with frontal zip - grey	OPA00810	1
Cushioned cover lid in PP - black	OPK0010N	1



OP9100EN

Components included in the standard configuration

Base in PP ReUse with caps and 6 plates
Cover dovetail joints in PP ReUse for base
Cover dovetail joints in PP ReUse for lateral panel - right and left
Silent Wheel, plastic, Ø125mm
Bumpers ø155mm for wheels ø125 mm in PP - grey
Anodized aluminium brackets 810 mm
Lateral panel in PP ReUse with dovetail joints
Central panel with sliding guides for drawers - black
Back closing panel in ABS - black
Top full size in PP ReUse with caps and plates
Anodized aluminum pushing handle complete with supports in PP ReUse
Shelf in PP ReUse 32x50 cm

OPTIONAL

Tray in PP ReUse 50x19xh16 cm

code	pcs
OPK0003N	1
OPABA80N	4
OPADX80N	8
OPASX80N	8
OPA00740	4
OPA00320	4
OPK05020	6
OPK0004N	4
OPK0005NX	2
OPKSX03NX	2
OPK0506N	1
OPK0511N	2
OPK0007N	4

code	pcs
OPA00700N	2



OP9300EN

Components included in the standard configuration

Base in PP ReUse with caps and 6 plates
Cover dovetail joints in PP ReUse for base
Cover dovetail joints in PP ReUse for lateral panel - right and left
Silent Wheel, plastic, Ø125mm
Bumpers ø155mm for wheels ø125 mm in PP - grey
Anodized aluminium brackets 810 mm
Lateral panel in PP ReUse with dovetail joints
Central panel with sliding guides for drawers - black
Back closing panel in ABS - black
Top full size in PP ReUse with caps and plates
Anodized aluminum pushing handle complete with supports in PP ReUse
Shelf in PP ReUse 32x50 cm
40L drawer in PP ReUse 45x29xh33 cm

code	pcs
OPK0003N	1
OPABA80N	4
OPADX80N	8
OPASX80N	8
OPA00740	4
OPA00320	4
OPK05020	6
OPK0004N	4
OPK0005NX	2
OPKSX03NX	2
OPK0506N	1
OPK0511N	2
OPK0007N	2
OPA0078N	4



OP9400EN

Components included in the standard configuration

	code	pcs
Base in PP ReUse with caps and 6 plates	OPK0003N	1
Cover dovetail joints in PP ReUse for base	OPABA80N	4
Cover dovetail joints in PP ReUse for lateral panel - right and left	OPADX80N OPASX80N	8
Silent Wheel, plastic, Ø125mm	OPA00740	4
Bumpers ø155mm for wheels ø125 mm in PP - grey	OPA00320	4
Anodized aluminium brackets 810 mm	OPK05020	6
Lateral panel in PP ReUse with dovetail joints	OPK0004N	4
Central panel with sliding guides for drawers - black	OPK0005NX	2
Back closing panel in ABS - black	OPKSX03NX	2
Right door in ABS with key lock - black	OPKDX22NX	1
Left door in ABS with key lock - black	OPKSX22NX	1
Top full size in PP ReUse with caps and plates	OPK0506N	1
Anodized aluminum pushing handle complete with supports in PP ReUse	OPK0511N	2
Cover for closing top in PP - black	OPA0061N	2
20L drawer in PP ReUse 45x29xh16 cm	OPA0077N	8
Safety sign holder in ABS - black	OPA0099NX	1
FixT handle holder in ABS with non-slip rubber roller - black	OPA0082NX	1



OP1110EN

Components included in the standard configuration	code	pcs
Base in PP ReUse with caps and 6 plates	OPK0003N	1
Cover dovetail joints in PP ReUse for base	OPABA80N	2
Cover dovetail joints in PP ReUse for lateral panel - right and left	OPADX80N OPASX80N	2
Silent Wheel, plastic, Ø125mm	OPA00740	4
Bumpers ø155mm for wheels ø125 mm in PP - grey	OPA00320	4
Base for waste bag in PP ReUse complete with plug and caps	OPK0516N	1
Bag support 120L in PP complete with lateral support and bag locking rings	OPKC5155N	1
Anodized aluminium brackets 810 mm	OPK05020	4
Lateral panel in PP ReUse with dovetail joints	OPK0004N	4
Back closing panel in ABS - black	OPKSX03NX	1
Left door in ABS with key lock - black	OPKSX22NX	1
Half top in PP ReUse complete with caps and plates	OPK0524N	1
Cushioned cover lid in PP - black	OPK0010N	1
Cushioned cover lid in PP with transparent document or Pad holder - black	OPK0021NX	1
Shelf in PP ReUse 32x50 cm	OPK0007N	1
7L bucket in PP ReUse 30x16xh23 cm - red handle	OPK0013NR	1
7L bucket in PP ReUse 30x16xh23 cm - blue handle	OPK0013NB	1
7L bucket in PP ReUse 30x16xh23 cm - yellow handle	OPK0013NY	1
Varnished metal support support for 22L bucket complete with 1 FixT - upper	OPA0C88S	1
Varnished metal support support for 22L bucket - lower	OPA0089S	1
22L disinfection bucket in PP	V13500	2
Safety sign holder in ABS - black	OPA0099NX	1
FixT handle holder in ABS with non-slip rubber roller - black	OPA0082NX	1
OPTIONAL	code	pcs
Plasticized bag 120L with front zip and logo TWT - grey	OPA00880	1
Plasticized bag 120L with front zip and logo TWT - black	OPA0088N	1
Lid for 22L disinfection bucket	V13501	2



OP1120EN

Components included in the standard configuration	code	pcs
Base in PP ReUse with caps and 6 plates	OPK0003N	1
Cover dovetail joints in PP ReUse for base	OPABA80N	2
Cover dovetail joints in PP ReUse for lateral panel - right and left	OPADX80N OPASX80N	2
Silent Wheel, plastic, Ø125mm	OPA00740	4
Bumpers ø155mm for wheels ø125 mm in PP - grey	OPA00320	4
Base for waste bag in PP ReUse complete with plug and caps	OPK0516N	1
Bag support 120L in PP complete with lateral support and bag locking rings	OPKC5155N	1
Anodized aluminium brackets 810 mm	OPK05020	6
Lateral panel in PP ReUse with dovetail joints	OPK0004N	4
Central panel with sliding guides for drawers - black	OPK0005NX	2
Back closing panel in ABS - black	OPKSX03NX	2
Right door in ABS with key lock - black	OPKDX22NX	1
Left door in ABS with key lock - black	OPKSX22NX	1
Top full size in PP ReUse with caps and plates	OPK0506N	1
Anodized aluminum pushing handle complete with supports in PP ReUse	OPK0511N	1
Cushioned cover lid in PP - black	OPK0010N	2
Cushioned cover lid in PP with transparent document or Pad holder - black	OPK0021NX	1
Shelf in PP ReUse 32x50 cm	OPK0007N	2
7L bucket in PP ReUse 30x16xh23 cm - red handle	OPK0013NR	1
7L bucket in PP ReUse 30x16xh23 cm - blue handle	OPK0013NB	1
7L bucket in PP ReUse 30x16xh23 cm - yellow handle	OPK0013NY	1
Varnished metal support support for 22L bucket complete with 1 FixT - upper	OPA0C88S	1
Varnished metal support support for 22L bucket - lower	OPA0089S	1
22L disinfection bucket in PP	V13500	2
Safety sign holder in ABS - black	OPA0099NX	1
FixT handle holder in ABS with non-slip rubber roller - black	OPA0082NX	1
OPTIONAL	code	pcs
Plasticized bag 120L with front zip and logo TWT - grey	OPA00880	1
Plasticized bag 120L with front zip and logo TWT - black	OPA0088N	1
Pedal for lid opening complete with aluminium bar	OPK1200S	1
Silent Wheel, plastic, Ø 80mm	S020180G	1
Lid for 22L disinfection bucket	V13501	2



OP1130EN

Components included in the standard configuration

Base in PP ReUse with caps and 4 plates
Cover dovetail joints in PP ReUse for base
Cover dovetail joints in PP ReUse for lateral panel - right and left
Silent Wheel, plastic, Ø125mm
Bumpers ø155mm for wheels ø125 mm in PP - grey
Anodized aluminium brackets 810 mm
Half top in PP ReUse complete with caps and plates
Lever holding bag for 2x70L- grey
Bag anchoring kit 6pcs
Central outer panel in PP - black
Anodized aluminum pushing handle complete with supports in PP ReUse
Cushioned cover lid in PP - black
Swivel tray support in grey painted metal - left
Swivel tray support in grey painted metal - right
Tray in PP ReUse 31x22xh12cm - red handles
Varnished metal support support for 22L bucket complete with 1 FixT - upper
Varnished metal support support for 22L bucket - lower
22L disinfection bucket in PP
Safety sign holder in ABS - black
FixT handle holder in ABS with non-slip rubber roller - black

code	pcs
OPK0002N	1
OPABA80N	4
OPADX80N	4
OPASX80N	4
OPA00740	4
OPA00320	4
OPK05020	4
OPK0524N	1
OPK1117S	1
OPK00120	1
OPK0533N	2
OPK0511N	1
OPK0010N	1
OPASX86S	1
OPADX86S	1
S0202001RN	2
OPA0C88S	1
OPA0089S	1
V13500	2
OPA0099NX	1
OPA0082NX	1

OPTIONAL

Plasticized bag 120L with front zip and logo TWT - grey
Plasticized bag 120L with front zip and logo TWT - black
Lid for 22L disinfection bucket

code	pcs
OPA00880	1
OPA0088N	1
V13501	2



OP1140EN



Components included in the standard configuration

Base in PP ReUse with caps and 6 plates
Cover dovetail joints in PP ReUse for base
Cover dovetail joints in PP ReUse for lateral panel - right and left
Silent Wheel, plastic, Ø125mm
Bumpers ø155mm for wheels ø125 mm in PP - grey
Anodized aluminium brackets 810 mm
Lateral panel in PP ReUse with dovetail joints
Central panel with sliding guides for drawers - black
Back closing panel in ABS - black
Right door in ABS with key lock - black
Left door in ABS with key lock - black
Top full size in PP ReUse with caps and plates
Lever holding bag for 2x70L- grey
Bag anchoring kit 6pcs
Plasticized bag 35L - grey
Anodized aluminum pushing handle complete with supports in PP ReUse
FixT handle holder in ABS with non-slip rubber roller for pushing handle - black
Cushioned cover lid in PP - black
Cushioned cover lid in PP with transparent document or Pad holder - black
Shelf in PP ReUse 32x50 cm
20L drawer in PP ReUse 45x29xh16 cm
40L drawer in PP ReUse 45x29xh33 cm
7L bucket in PP ReUse 30x16xh23 cm - red handle
7L bucket in PP ReUse 30x16xh23 cm - blue handle
7L bucket in PP ReUse 30x16xh23 cm - yellow handle
Varnished metal support support for 22L bucket complete with 1 FixT - upper
Varnished metal support support for 22L bucket - lower
22L disinfection bucket in PP
Safety sign holder in ABS - black
FixT handle holder in ABS with non-slip rubber roller - black

code	pcs
OPK0003N	1
OPABA80N	4
OPADX80N	4
OPASX80N	4
OPA00740	4
OPA00320	4
OPK05020	6
OPK0004N	4
OPK0005NX	2
OPKSX03NX	2
OPKDX22NX	1
OPKSX22NX	1
OPK0506N	1
OPK1117S	1
OPK00120	1
OPA00890	2
OPK0511N	2
OPK0513NX	1
OPK0010N	1
OPK0021NX	1
OPK0007N	2
OPA0077N	3
OPA0078N	1
OPK0013NR	1
OPK0013NB	1
OPK0013NY	1
OPA0C88S	1
OPA0089S	1
V13500	2
OPA0099NX	1
OPA0082NX	1

OPTIONAL

Lid for 22L disinfection bucket

code	pcs
V13501	2

OPERA 11.5 R HEALTHCARE

OP1150EN



OP1150EN

Components included in the standard configuration	code	pcs
Base in PP ReUse with caps and 6 plates	OPK0003N	1
Cover dovetail joints in PP ReUse for base	OPABA80N	4
Cover dovetail joints in PP ReUse for lateral panel - right and left	OPADX80N OPASX80N	4
Silent Wheel, plastic, Ø125mm	OPA00740	4
Bumpers ø155mm for wheels ø125 mm in PP - grey	OPA00320	4
Anodized aluminium brackets 810 mm	OPK05020	6
Lateral panel in PP ReUse with dovetail joints	OPK0004N	4
Central panel with sliding guides for drawers - black	OPK0005NX	2
Back closing panel in ABS - black	OPKSX03NX	2
Right door in ABS with key lock - black	OPKDX22NX	1
Left door in ABS with key lock - black	OPKSX22NX	1
Top full size in PP ReUse with caps and plates	OPK0506N	1
Bag anchoring kit 6pcs	OPK00120	1
Fixing levels for bag 120 L (1pcs) - grey	OPA0066S	2
Anodized aluminum pushing handle complete with supports in PP ReUse	OPK0511N	2
Cushioned cover lid in PP - black	OPK0010N	1
Cushioned cover lid in PP with transparent document or Pad holder - black	OPK0021NX	1
Shelf in PP ReUse 32x50 cm	OPK0007N	1
7L bucket in PP ReUse 30x16xh23 cm - red handle	OPK0013NR	1
7L bucket in PP ReUse 30x16xh23 cm - blue handle	OPK0013NB	1
7L bucket in PP ReUse 30x16xh23 cm - yellow handle	OPK0013NY	1
10L drawer in PP ReUse 45x29xh8,5 cm	OPA0076N	1
Varnished metal support support for 22L bucket complete with 1 FixT - upper	OPA0C88S	1
Varnished metal support support for 22L bucket - lower	OPA0089S	1
22L disinfection bucket in PP	V13500	2
Safety sign holder in ABS - black	OPA0099NX	1
FixT handle holder in ABS with non-slip rubber roller - black	OPA0082NX	1

OPTIONAL

Lid for 22L disinfection bucket

code	pcs
V13501	2

Product dimensions 1300x620xh1070 mm Weight 40 kg Packaging 1140x800xh500 mm Volume 0,456 mc

OPERA 11.8 R HEALTHCARE

OP1180EN



OP1180EN

Components included in the standard configuration	code	pcs
Base in PP ReUse with caps and 6 plates	OPK0003N	1
Cover dovetail joints in PP ReUse for base	OPABA80N	2
Cover dovetail joints in PP ReUse for lateral panel - right and left	OPADX80N OPASX80N	6
Kit fixed wheels ø245mm in polyurethane with screws and 2 supports	OPK00245	1
Rubber wheel for outdoor Ø150mm with screw Ø10 MA	OPA0100	2
Anodized aluminium brackets 810 mm	OPK05020	6
Lateral panel in PP ReUse with dovetail joints	OPK0004N	4
Central panel with sliding guides for drawers - black	OPK0005NX	2
Back closing panel in ABS - black	OPKSX03NX	2
Right door in ABS with key lock - black	OPKDX22NX	1
Left door in ABS with key lock - black	OPKSX22NX	1
Top full size in PP ReUse with caps and plates	OPK0506N	1
Bag anchoring kit 6pcs	OPK00120	1
Fixing levels for bag 120 L (1pcs) - grey	OPA0066S	2
Plasticized bag 35L - grey	OPA00890	2
Anodized aluminum pushing handle complete with supports in PP ReUse	OPK0511N	2
Cushioned cover lid in PP - black	OPK0010N	2
Shelf in PP ReUse 32x50 cm	OPK0007N	2
20L drawer in PP ReUse 45x29xh16 cm	OPA0077N	1
40L drawer in PP ReUse 45x29xh33 cm	OPA0078N	1
7L bucket in PP ReUse 30x16xh23 cm - red handle	OPK0013NR	1
7L bucket in PP ReUse 30x16xh23 cm - blue handle	OPK0013NB	1
7L bucket in PP ReUse 30x16xh23 cm - yellow handle	OPK0013NY	1
Tray in PP ReUse 50x19xh16 cm	OPA00700N	2
Safety sign holder in ABS - black	OPA0099NX	1
FixT handle holder in ABS with non-slip rubber roller - black	OPA0082NX	1

Product dimensions 1090x620xh1080 mm Weight 41 kg Packaging 1140x800xh500 mm Volume 0,456 mc



OP2500EN

Components included in the standard configuration

Compact base in PP ReUse with 4 plates
 Cover dovetail joints in PP ReUse for base
 Cover dovetail joints in PP ReUse for lateral panel - right and left
 Silent Wheel, plastic, Ø125mm
 Bumpers ø155mm for wheels ø125 mm in PP - grey
 Anodized aluminium brackets 1241 mm - Maxi
 Lateral panel in PP ReUse with dovetail joints
 Back closing panel in ABS - black
 Back closing panel in ABS single - black
 Left single door with ABS key lock - black
 Left door in ABS with key lock - black
 Half top in PP ReUse complete with caps and plates
 Half top in PP ReUse with hole
 Anodized aluminum pushing handle complete with supports in PP ReUse
 Cover for closing top in PP - black
 Shelf in PP ReUse 32x50 cm
 20L drawer in PP ReUse 45x29xh16 cm

code	pcs
OPK00C11N	1
OPABA80N	4
OPADX80N OPASX80N	12
OPA00740	4
OPA00320	4
OPK05260	4
OPK0004N	6
OPKSX03NX	1
OPKSX25NX	1
OPKSX08NX	1
OPKSX22NX	1
OPK0524N	1
OPK0543N	1
OPK0511N	2
OPA0061N	2
OPK0007N	1
OPA0077N	1

Product dimensions 550x620xh1480 mm Weight 23 kg Packaging 1140x800x500 mm Volume 0,456 mc



OP2700EN

Components included in the standard configuration

Compact base in PP ReUse with 4 plates
 Cover dovetail joints in PP ReUse for base
 Cover dovetail joints in PP ReUse for lateral panel - right and left
 Silent Wheel, plastic, Ø125mm
 Bumpers ø155mm for wheels ø125 mm in PP - grey
 Anodized aluminium brackets 810 mm
 Lateral panel in PP ReUse with dovetail joints
 Back closing panel in ABS - black
 Left door in ABS with key lock - black
 Half top in PP ReUse complete with caps and plates
 Anodized aluminum pushing handle complete with supports in PP ReUse
 Cushioned cover lid in PP - black
 Shelf in PP ReUse 32x50 cm
 20L drawer in PP ReUse 45x29xh16 cm

code	pcs
OPK00C11N	1
OPABA80N	4
OPADX80N OPASX80N	8
OPA00740	4
OPA00320	4
OPK05020	4
OPK0004N	4
OPKSX03NX	1
OPKSX22NX	1
OPK0524N	1
OPK0511N	1
OPK0010N	1
OPK0007N	1
OPA0077N	1

Product dimensions 550x620xh1070 mm Weight 21 kg Packaging 1000x700x500 mm Volume 0,350 mc



OP20100EN

Components included in the standard configuration

	code	pcs
Base in PP ReUse with caps and 6 plates	OPK0003N	1
Compact base in PP ReUse with 4 plates	OPK00C11N	1
Cover dovetail joints in PP ReUse for base	OPABA80N	6
Cover dovetail joints in PP ReUse for lateral panel - right and left	OPADX80N OPASX80N	22
Silent Wheel, plastic, Ø125mm	OPA00740	8
Bumpers ø155mm for wheels ø125 mm in PP - grey	OPA00320	8
Base for waste bag in PP ReUse complete with plug and caps	OPK0516N	1
Bag support 120L in PP complete with lateral support and bag locking rings	OPKC5155N	1
Anodized aluminium brackets 1241 mm - Maxi	OPK05260	10
Lateral panel in PP ReUse with dovetail joints	OPK0004N	12
Central panel with sliding guides for drawers - black	OPK0005NX	3
Back closing panel in ABS single - black	OPKSX25NX	3
Back closing panel in ABS - black	OPKSX03NX	3
Right single door with ABS key lock - black	OPKDX08NX	1
Left single door with ABS key lock - black	OPKSX08NX	2
Right door in ABS with key lock - black	OPKDX22NX	1
Left door in ABS with key lock - black	OPKSX22NX	2
Top full size in PP ReUse with caps and plates	OPK0506N	1
Top full size in PP ReUse with hole	OPK0542N	1
Half top in PP ReUse complete with caps and plates	OPK0524N	1
Half top in PP ReUse with hole	OPK0543N	1
Anodized aluminum pushing handle complete with supports in PP ReUse	OPK0511N	4
Cover for closing top in PP - black	OPA0061N	6
Cushioned cover lid in PP with transparent document or Pad holder - black	OPK0021NX	1
Shelf in PP ReUse 32x50 cm	OPK0007N	3
20L drawer in PP ReUse 45x29xh16 cm	OPA0077N	3
Right and left coupling kit complete with plugs for Van Opera	OPK0090	1
Safety sign holder in ABS - black	OPA0099NX	1
FixT handle holder in ABS with non-slip rubber roller - black	OPA0082NX	1

OPTIONAL

	code	pcs
Plasticized bag 120L with front zip and logo TWT - grey	OPA00880	1
Plasticized bag 120L with front zip and logo TWT - black	OPA0088N	1

Product dimensions	2060x620xh1480 mm	Weight	75 kg	Packaging	1140x800xh500 mm + 800x1200x1050 mm	Volume	1,464 mc
---------------------------	-------------------	---------------	-------	------------------	--	---------------	----------



OP20200EN

Components included in the standard configuration

	code	pcs
Base in PP ReUse with caps and 4 plates	OPK0002N	1
Compact base in PP ReUse with 4 plates	OPK00C11N	1
Cover dovetail joints in PP ReUse for base	OPABA80N	8
Cover dovetail joints in PP ReUse for lateral panel - right and left	OPADX80N OPASX80N	16
Silent Wheel, plastic, Ø125mm	OPA00740	8
Bumpers ø155mm for wheels ø125 mm in PP - grey	OPA00320	8
Anodized aluminium brackets 810 mm	OPK05020	8
Lateral panel in PP ReUse with dovetail joints	OPK0004N	8
Back closing panel in ABS - black	OPKSX03NX	2
Left door in ABS with key lock - black	OPKSX22NX	2
Half top in PP ReUse complete with caps and plates	OPK0524N	2
Anodized aluminum pushing handle complete with supports in PP ReUse	OPK0511N	1
Cushioned cover lid in PP - black	OPK0010N	2
Shelf in PP ReUse 32x50 cm	OPK0007N	2
Support for wringer in grey varnished metal ø20mm	OPK05270	1
Prexa wringer - black	S0100201NR	1
15L bucket in PP - red handle	S0201502N	1
15L bucket in PP - blue handle	S0201503N	1
7L bucket in PP ReUse 30x16xh23 cm - red handle	OPK0013NR	1
7L bucket in PP ReUse 30x16xh23 cm - blue handle	OPK0013NB	1
7L bucket in PP ReUse 30x16xh23 cm - yellow handle	OPK0013NY	1
20L drawer in PP ReUse 45x29xh16 cm	OPA0077N	2
Right and left coupling kit complete with plugs for Van Opera	OPK0090	1
Safety sign holder in ABS - black	OPA0099NX	1
FixT handle holder in ABS with non-slip rubber roller - black	OPA0082NX	1



Product dimensions 1520x620xh1070 mm Weight 55 kg Packaging 1140x800xh500 mm + 1000x700xh500 mm Volume 0,806 mc



Description	code	pcs
Base in PP ReUse with caps and 4 plates	OPK0002N	1
Base in PP ReUse with caps and 6 plates	OPK0003N	1
Compact base in PP ReUse with 4 plates	OPK00C11N	1
Cover dovetail joints in PP ReUse for base	OPABA80N	1
Base for waste bag in PP ReUse complete with plug and caps	OPK0516N	1
Base for waste bag in PP ReUse with Silent Wheel Ø 80mm	OPKC056N	1
Half top in PP ReUse complete with caps and plates	OPK0524N	1
Half top in PP ReUse with hole	OPK0543N	1
Top full size in PP ReUse with caps and plates	OPK0506N	1
Top full size in PP ReUse with hole	OPK0542N	1
Bag support 120L in PP complete with lateral support and bag locking rings	OPKC5155N	1
Fixing levels for bag 120 L (1pcs) - grey	OPA0066S	1
Kit fixing levels for bag 120 L (2pcs) - grey	OPK067S	1
Lever holding for bag 2x70L - grey	OPK1117S	1
Bag anchoring kit 6pcs	OPK00120	1
Bag holder kit 40L in PP with red, blue, yellow handle - black	OPK300N	1



Description	code	pcs
Silent Wheel, plastic, Ø 80mm	S020180G	1
Wheel, metal, Ø 100mm	MO201RU3	1
Silent Wheel, plastic, Ø125mm	OPA00740	1
Silent Wheel, plastic, Ø125mm with screw Ø10 MA with brake	OPA00740F	1
Wheel for moquette Ø125mm with screw Ø10 MA	OPA0090G	1
Rubber wheel for outdoor Ø150mm with screw Ø10 MA	OPA0100	1
Fixed wheels ø245mm in polyurethane with screws and 2 supports	OPKR00245	1
Bumper ø155mm for wheels ø125 mm in PP - grey	OPA00320	1
Anodized aluminium brackets 450 mm - Mini	OPK05280	1
Anodized aluminium brackets 810 mm	OPK05020	1
Anodized aluminium brackets 290 mm - Extra midi	OPK05295	1
Anodized aluminium brackets 1070 mm - Midi	OPK05290	1
Anodized aluminium brackets 1241 mm - Maxi	OPK05260	1













Description	code	pcs
Lateral panel in PP ReUse with dovetail joints	OPK0004N	1
Central panel with sliding guides for drawers - black	OPK0005NX	1
Cover dovetail joints in PP ReUse for lateral panel - left	OPASX80N	1
Cover dovetail joints in PP ReUse for lateral panel - right	OPADX80N	1
Back closing panel in ABS - black	OPKSX03NX	1
Back closing panel in ABS single - black	OPKSX25NX	1
Left door in ABS with key lock - black	OPKSX22NX	1
Right door in ABS with key lock - black	OPKDX22NX	1
Left single door with ABS key lock - black	OPKSX08NX	1
Right single door with ABS key lock - black	OPKDX08NX	1
Cover for closing top in PP - black	OPA0061N	1
Cover lid in PP - black	OPK0010N	1
Cover lid in PP with key - black	OPK0011N	1
Cover lid in PP with transparent document or Pad holder - black	OPK0021NX	1



Description	code	pcs
Full shelf 50x70 cm made of wood with metal blocking device - black	OPK00690	1
Shelf in PP ReUse 32x50 cm	OPK0007N	1
7L bucket in PP ReUse 30x16xh23 cm		
red handle	OPK0013NR	1
blue handle	OPK0013NB	1
green handle	OPK0013NG	1
yellow handle	OPK0013NY	1
Tray 5Lt in PP ReUse 28x14x17h cm	OPK008N	1
Pre-impregnation grid in PP 16x30cm for bucket 7L	OPA0202	1
Pre-impregnation lid in PP 16x30cm for bucket 7L	OPA0203	1
Tray with handles in PP ReUse 31x22xh12cm		
red handles	S0202001RN	1
blue handles	S0202001BN	1
Tray without handles in PP ReUse 31x22xh12cm	S020200N	1
Swivel tray support in grey painted metal		
right	OPKDX86SN	1
left	OPKSX86SN	1
Kit tray in PP 50x19xh16 cm complete with hooks	OPK00700N	1
Tray in PP ReUse 50x19xh16 cm	OPA00700N	1
Tray hooks (2pcs) complete with support and screws	OPK0071S	1
Lid in PP for tray 50x19xh16 cm	OPA0204	1

Description	code	pcs
 10L drawer in PP ReUse 45x29xh8,5 cm	OPA0076N	1
 20L drawer in PP ReUse 45x29xh16 cm	OPA0077N	1
 40L drawer in PP ReUse 45x29xh33 cm	OPA0078N	1
 Drawer support in ABS with stainless steel screw	OPA0070S	1
 Pre-impregnation grid in PP 32x49cm for drawers 20L and 40L	OPA0200	1
 Pre-impregnation lid in PP 32x49cm for drawers 20L and 40L	OPA0201	1
 22L disinfection bucket in PP	V13500	1
 Lid for 22L disinfection bucket	V13501	1
 Varnished metal support for 22L bucket complete with 1 FixT - upper	OPA0C88S	1
 Varnished metal support for 22L bucket - lower	OPA0089S	1

Description	code	pcs
 PREXA S down press wringer with press bar in Delrin - without rubber inserts	S0100201NR	1
 PREXA I down press wringer, POM wringing bars - with rubber inserts	S0100101NX	1
 Support for wringer in grey varnished metal ø20mm	OPK05270	1
 15L bucket in PP ReUse - blue handle	S0201502N	1
 15L bucket in PP ReUse - red handle	S0201503N	1
 Anodized aluminum pushing handle complete with supports in PP ReUse	OPK0511N	1
 Right and left coupling kit complete with plugs for Van Opera	OPK0090	1
 FixT handle holder in ABS with non-slip rubber roller for pushing handle - black	OPK0513NX	1
 FixT handle holder in ABS with non-slip rubber roller - black	OPA0082NX	1
 Safety sign holder in ABS - black	OPA0099NX	1
 Mop holder for base in polyethylene complete with screws	OPA00730	1
 Frame holder with red cover lid - black	OPK0514RN	1

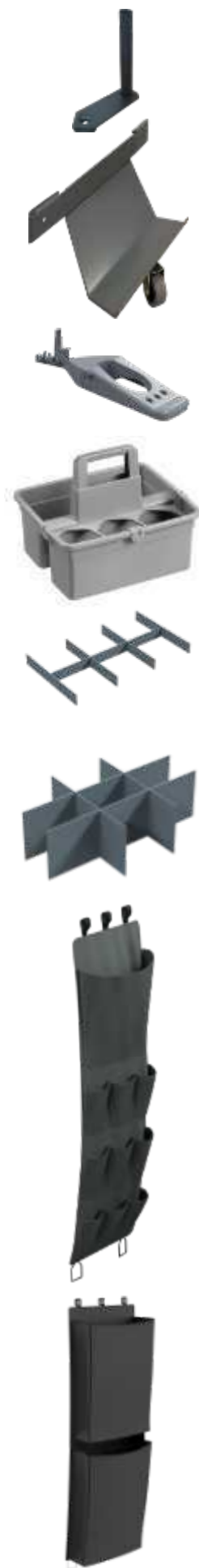

Description	code	pcs
Roll holder in grey painted metal	OPK3120S	1
Imop holder in grey painted metal	OPK10300VR	1
Imop velcro closing belt	OPK10150I	1
Pedal for lid opening complete with aluminium bar	OPK1200S	1
Plastic box with bottle holder	OPCS001	1
Divider 6 compartments for top - 47x28xh4 cm	OPA01900	1
Divider 6 compartments for drawers 10L - 43x28xh4 cm	OPA01700	1
for drawers 20L - 43x28xh13 cm	OPA01600	1
Holder for Hotel trolleys		
with 10 pockets - black	OPA0090N	1
with 10 pockets - grey	OPA00900	1
Holder for Hotel trolleys 2x70L - black	OPA00901N	1



Description	code	pcs
Net for mop washing 35L		
blue stripes	TA0035B	10
yellow stripes	TA0035Y	10
red stripes	TA0035R	10
green stripes	TA0035G	10
Net for mop washing 120L	TA00120	10
SPRY GO	APDEW001	1
Plasticized bag 35L - grey	OPA00890	1
Plasticized bag 120L with frontal zip and logo TWT - grey	OPA00880	1
Plasticized bag 120L with frontal zip and logo TWT - black	OPA0088N	1
Plasticized bag 120L with lateral zip and logo TWT - grey	OPA00880.L	1
Vertical laundry bag 200L with frontal zip - grey	OPA00810	1
Laundry bag 260L with hinge		
grey	OPA00850	1
black	OPA00850N	1

X TROLLEY



X TROLLEY - PAINTED METAL



Description	code	pcs
X TROLLEY painted with round bag support complete with elastic bag holder Metal wheels Ø80mm	C0200202	3



X TROLLEY painted without bag holder complete with hooks Metal wheels Ø80mm Optional: Bag 120 L	C0200302	3
--	-----------------	---



X TROLLEY painted with square bag support complete with bag clip Metal wheels Ø80mm	C0200402	3
---	-----------------	---

X TROLLEY - CHROMED METAL



Description	code	pcs
X TROLLEY chromed with round bag support complete with elastic bag holder Metal wheels Ø80mm with bumpers Ø90mm	C0200201	2



X TROLLEY chromed without bag holder complete with hooks Metal wheels Ø80mm with bumpers Ø90mm Optional: Bag 120L	C0200301	2
--	-----------------	---



X TROLLEY chromed with round bag support complete with bag clip Metal wheel Ø80mm with bumpers Ø90mm	C0200401	2
--	-----------------	---



Description	code	pcs
FLY open/close plastic dustbin with broom	AIS001A	6
FixT universal handle holder with hose clamp Ø22 mm	C0202401	1
Round bag support for chromed X trolley	C0201201	1
Round bag support for painted X trolley	C0201102	1
Square bag support for chromed X trolley	C0201301	1
Square bag support for painted X trolley	C0201402	1
Elastic bag holder for X trolley	C0201501	10
Plasticized basket 41x23x19 cm - white	C0201601	5
Bag Lt 120 in PVC with rings for square support - grey	C0202201	1
Bag Lt 120 in PVC with rings for square support - black	C0202201N	1
Bag Lt 120 in polyester with string for round support - grey	C0202301	1
Chromed paper holder	C0202001	1
Painted paper holder	C0202102	1
Holder with 9 pockets - grey	CT2005	1

MULTI BIN TROLLEY



Description	code	pcs
MULTI BIN 1 CHROMED chromed bag holder complete with elastic bag holder, metal wheels Ø80 mm with bumpers Ø90 mm Optional: Bag 70L	C0300401	2
MULTI BIN 1 PAINTED painted bag holder complete with elastic bag holder, metal wheels Ø80 mm with bumpers Ø90 mm Optional: Bag 70L	C0300402	2
MULTI BIN 2 CHROMED 2 chromed bag holders complete with elastic bag holders, metal wheels Ø80 mm with bumpers Ø90 mm Optional: Bag 70 L	C0300201	1
MULTI BIN 2 PAINTED 2 painted bag holders complete with elastic bag holders, metal wheels Ø80 mm with bumpers Ø90 mm Optional: Bag 70 L	C0300202	1
MULTI BIN 3 CHROMED 3 chromed bag holders complete with elastic bag holders, metal wheels Ø80 mm with bumpers Ø90 mm Optional: Bag 70 L	C0300501	1
MULTI BIN 3 PAINTED 3 painted bag holders complete with elastic bag holders, metal wheels Ø80 mm with bumpers Ø90 mm Optional: Bag 70 L	C0300502	1

Description	code	pcs
 Bag 70 L in polyester - orange	C0102101	1
 Bag 70 L in polyester - grey	C0102102	1
 Metal wheels Ø80 mm	M0201RU2	1
 Bumper Ø90 mm - grey	S0201901G	1
 FixT universal handle holder with hose clamp Ø22 mm	C0202401	1



Description	code	pcs
AURORA PP trash bin with swing lid - white		
15 L	ABP00115	8
25 L	ABP00125	8
50 L	ABP00150	8
SWING FIT PP trash bin with swing lid - grey		
10 L	ABP00210	6
25 L	ABP00225	6
50 L	ABP00250	6
Trash bin 24L in PP with pedal for lid opening - white and blue	ABP00325	4
Trash bin 90L in PP with pedal for lid opening - grey	ABP00390	6
Trash bin 100L with wheels		
blue lid	BIDRU100B	1
red lid	BIDRU100R	1
green lid	BIDRU100G	1
yellow lid	BIDRU100Y	1
Trash bin 120L with wheels		
white	BIDRU120W	1
green	BIDRU120G	1
Kit pedal for lid opening	BIDKITPD120	1

WINDOW CLEANING

TWT by LEWI

TWT window cleaning line is developed in collaboration with LEWI PROFESSIONAL, a German leader in this sector. These are professional tools characterized by great quality and efficacy appreciated by all window cleaning specialists.

-  **Innovative**
-  **Solid**
-  **Manoeuvrable**

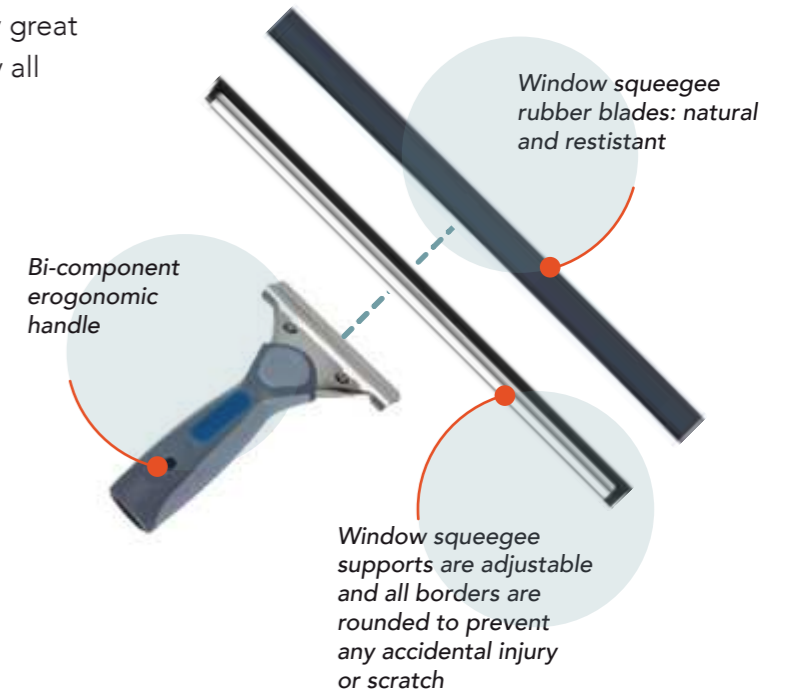

Innovative materials: thanks to a particular manufacture process, the alluminium poles are more strong and solid, mateining a great lightness to reach till 16 m height.

New locking connectors: the anti-rotation system improves the control and safety of tool when working at great heights.

Safe connection technology: all tools are locked through a safety connection cone to prevent accidental falls while working at great heights.

WINDOW CLEANING

Description	code	pcs
 BIONIC - Squeegee with ergonomic handle		
25 cm	V10510	10
35 cm	V10511	10
45 cm	V10512	10
55 cm	V10513	10
 BIONIC - ergonomic handle	V10534	20
 CLASSIC - stainless steel squeegee with rubber handle		
25 cm	V10520	10
35 cm	V10521	10
45 cm	V10522	10
55 cm	V10523	10
 CLASSIC - non - slip rubber handle	V10535	20
 BIONIC DUO - squeegee with white sleeve and ergonomic handle		
35 cm	V10501	10
45 cm	V10502	10
 T-BAR - plastic and aluminium support for sleeve		
25 cm	V10038	10
35 cm	V10039	10
45 cm	V10040	10
 WHITE SCRUB - polyester fastener sleeve with velcro and abrasive band		
25 cm	V1025	10
35 cm	V1035	10
45 cm	V1045	10
 BLUE STAR - polyester and microfiber fastener sleeve with velcro		
25 cm	V10012	10
35 cm	V10013	10
45 cm	V10014	10
 WHITE STAR - polyester fastener sleeve with velcro		
25 cm	V10004	10
35 cm	V10005	10
45 cm	V10006	10

WINDOW CLEANING

Description	code	pcs
 Rubber blade		
25 cm	V11020	10
35 cm	V11022	10
45 cm	V11024	10
55 cm	V11025	10
92 cm	V11026	10
 Stainless steel channel with rubber		
25 cm	V11006	25
35 cm	V11007	25
45 cm	V11008	25
55 cm	V11009	25
 22 L disinfection bucket in PP	V13500	10
 Lid for 22 L disinfection bucket in PP	V13501	10
 22 L bucket with wheels Ø50 mm complete with wringer	V13900	1
 Two sections pole with twisting mechanism		
200 cm (2 pcs x 100 cm)	V12019	10
300 cm (2 pcs x 150 cm)	V12020	10
400 cm (2 pcs x 200 cm)	V12021	10
 Two sections pole		
250 cm (2 pcs x 125 cm)	V12001	10
300 cm (2 pcs x 150 cm)	V12002	10
400 cm (2 pcs x 200 cm)	V12003	10
500 cm (2 pcs x 250 cm)	V12004	10
 Three sections pole		
300 cm (3 pcs x 100 cm)	V12006	10
450 cm (3 pcs x 150 cm)	V12007	10
600 cm (3 pcs x 200 cm)	V12008	10
 Four sections pole		
600 cm (4 pcs x 150 cm)	V12012	10
800 cm (4 pcs x 200 cm)	V12013	10
 Angle joint for poles	V12022	10
 Cone with Italian thread	V12040	10
 Cup to adapt italian screw for pole	MFILO10B	1

WINDOW CLEANING









Description	code	pcs
Professional wall brush curved - horsehair	V12025	10
Professional wall brush oval - horsehair	V12027	10
Wall brush oval	V20001	10
C-shaped wall brush	V20011	10
WATER POLE		
240 cm (2 x 120 cm)	V14502	1
400 cm (2 x 200 cm)	V14503	1
600 cm (2 x 300 cm)	V14504	1
Brush for Water Pole	V14508	1
Safety scraper with retractable blade 4 cm	V11501	20
Safety scraper with rubber cover and retractable blade 4 cm	V11502	15
Blades for scrapers 5 blades of 4 cm	V11513	10
4 cm blades - 100 pcs per box	V11512	100
Stainless steel pocket scraper, 10 cm	V11505	10
Blades for pocket scraper, 10 cm, 25 pcs dispenser	V11509	10
Blades for pocket scraper, 10 cm, 350 pcs box	V11510	350

WINDOW CLEANING



Description	code	pcs
Surface scraper BIONIC, ergonomic handle, 10 cm, blade cover	V11500	10
Scraper for window or floor		
25 cm Floor scraper, 10 cm blade	V11503	10
120 cm Floor scraper, 10 cm blade	V11504	10
Blades for floor scraper, 10 cm, 10pcs box	V11511	10
Multipurpose clamp with aluminium handle		
40 cm	A12502	10
100 cm	A12503	10
Description		
LEWI WINDOW CLEANING KIT complete with: BIONIC Squeegee with ergonomic handle 25 cm, 35 cm, 45 cm Rubber replacement 92cm - T-bar in aluminium 35 cm - Sleeve WHITE STAR 25 cm with abrasive velcro closing - Surface scraper BIONIC, ergonomic handle, 10 cm, blade cover - Angle end for pole - Telescopic pole 2x60cm - Oval wall brush - Sponge Topbrown with abrasive fiber - Professional chamois leather	V01000	1



Description	code	pcs
 Brass support with rubber 25 cm 35 cm 45 cm	V1127	12
	V1135	12
	V1144	12
 ETTORE brass fixed handle	V1324	12
 ETTORE non-slip rubber grip handle	V1339	12
 ETTORE brass swivel handle	V1640	12
 brass clips for fixing rubber	V1253	12
 ETTORE rubber blade 25 cm 35 cm 45 cm 90 cm	V1407	12
	V1497	12
	V1503	12
	V1521	12
 yellow sleeve replacement 25 cm 35 cm 45 cm	V1625	10
	V1635	10
	V1645	10

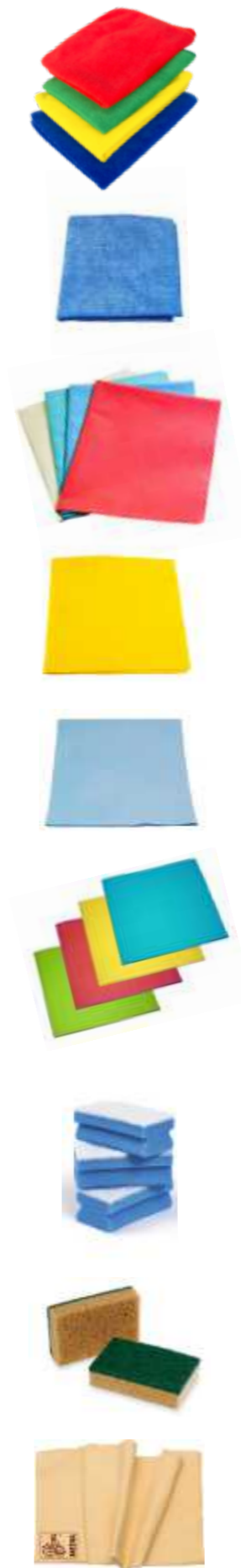







Description	code	pcs
Microfiber cloth 40x40 cm		
Blue	P0100001	20
Red	P0100002	20
Yellow	P0100003	20
Green	P0100004	20
MICRO STEEL BLUE - microfiber cloth with polyurethane treatment indicated to clean steel surfaces 37x35 cm	P1000020	20
MICRO LUX - ultra microfiber, non-woven polyester/polyamide 35x40 cm		
Red	P1000030	50
Blue	P1000031	50
Green	P1000032	50
Yellow	P1000033	50
MILLE USI - viscose/polypropylene cloth 38x38 cm	P1000040	250
MICRO GLASS - ultra microfiber, non-woven polyester/polyamide cloth 40x50 cm	P1000050	50
GISY - sponge cloth 18x20 cm (packs of 10 pcs in boxes of 60 sponges)		
Blue	P0301001	60
Red	P0301002	60
Yellow	P0301003	60
Green	P0301004	60
Bi Color Sponge - packs of 10 sponges in boxes of 100 sponges		
Blue	P030001	100
Red	P030002	100
Yellow	P030003	100
Green	P030004	100
TopBrown Sponge - classic sponge with abrasive fiber 14x9,5x4,5 cm	P031000	100
Professional chamois leather 100% natural 60x40 cm	P15004	10

DISPENSER

IN ABS

Description	code	pcs
 paper dispenser "C", "Z", "V"	DIS0003	1
 EASY paper dispenser "C" interleaved capacity 150/200 wipes	DIS0001	32
 FRANKY toilet paper double rolls or interleaved	DIS0002	24
 JUMBO toilet paper with 260mm roll	DIS0005	10
 HYGIEN wc set cover	DIS0006	20
 Refill toilet cover sheets (250 sheets)	DIS0006.R	10

Description	code	pcs
 SONY manual soap dispenser 800 ml	DIS0004	12
 Soap dispenser 1000 ml with photocell	DIS0014	12
 Battery-powered perfume dispenser with fan	DIS0007	1
 Perfume refill 100 ml mandarin/orange essence fruit mix essence	DIS0007R.M DIS0007R.F	12 12
 Air hand dryers with photocell (1800W)	DIS0020	15
 VENTO wall hair dryer (1600W) - white	DIS0030	19



Description	code	pcs
Bin in stainless steel complete with pedal and bucket		
3 L	ABM00103	6
5 L	ABM00105	4
12 L	ABM00112	2



Wc brush in stainless steel	DIS0010	12
-----------------------------	----------------	----



Wc brush in plastic	DIS0011	12
---------------------	----------------	----



Wall paper holder - white painted	C0202105	1
-----------------------------------	-----------------	---



Paper holder - white painted	C0202106	1
------------------------------	-----------------	---



Purchase orders placed to TWT Srl are submitted to the ongoing sales terms and conditions, except otherwise agreed between the Parties in each specified contract

1. TWT PRODUCTS

a. All products manufactured by TWT Srl conform to safety and quality standards and are suitable for their proper use.
b. Technical specifications, descriptions and pictures related to various products listed herein are purely indicative and TWT Srl reserves the right to amend such information in the case any change is considered necessary.

2. PRICES

a. All prices herein do not include VAT and delivery terms are EX-Works Castelfranco Veneto (TV).
b. The prices herein specified are valid until further modified

3. PURCHASE ORDERS

a. All purchase orders are accepted only after approval by TWT Srl.
b. Minimum amount per order accepted is € 500,00, VAT not included.
c. All quantities in the purchase orders shall refer the standard single packing; quantities ordered shall be multiples of the single packing.
d. Each purchase order shall include product code, description and quantities requested.

4. PACKAGING

a. Packaging is included in the price list only if products are packed following TWT standards.
b. Extra charges are added for customized packaging, on request. For mop wringers packed separately from the trolley, an extra charge of € 0,70 will be added.

5. PAYMENT

a. The client undertakes to pay for the goods in accordance with the terms agreed with TWT Srl and indicated in the invoice.
b. In case of expired and delayed payments, the interest shall be calculated at the current rate.
c. Goods are to be retained of TWT Srl exclusive property until payment made.

6. DELIVERY TIMES

a. Delivery times are agreed in the trade agreements.
b. Delivery times are not compulsory. A delay in the delivery shall not be cause of any delay in payment and not allow to any request for damages.

7. TRANSPORT

a. The withdrawal and transport of goods are at Client's expenses.
b. The cost of transport is normally at Client's expense, unless otherwise agreed between the Parties.

8. NON-COLLECTION OF GOODS

a. Non-collection of goods, within a period of thirty days from the date agreed, shall allow the seller to cancel the contract "ipso iure". Any payment received in advance shall be withheld by the seller, as penalty, except for the case of a heavier loss.

9. SALES RETURNS

a. All returns are subject to prior approval by TWT Srl.
b. Once the returns are authorised, the goods shall return free of damage and in their original packaging. Otherwise, packaging costs shall be added.
c. All transport costs are on the client's expense.

10. HOW TO USE GOODS

a. TWT Srl shall not be liable for any damage caused by or to the products due to improper use, non-compliance with the instructions (where provided), lack or inaccurate maintenance, tampering or alteration of the products.

11. CLAIMS

a. Once the goods have been delivered at his premises, the Client shall check and inspect them. Any remarks or comments related to damages or missing items shall be made at the moment of delivery to the carrier and mentioned on the delivery note.
b. Any defects or lacks shall be notified in writing to the seller within the times described by the law in force.
c. Claims received verbally or on the phone shall not be considered as valid.
d. No claims shall be accepted without authorization by TWT Srl.

12. PRICE LIST

a. The current price list cancels all previous price lists.

13. IMAGES AND TRADEMARK

a. Images, photos, company logo and each form of representation of TWT Srl items and trademark are of its own property. Their use is therefore forbidden, unless expressly authorized by TWT Srl.

14. ACCEPTANCE OF SALES TERMS AND CONDITIONS

a. The Client expressly agrees to all the sales terms and conditions herein once he places a purchase order.

15. APPLICABLE LAW AND COMPETENT COURT

a. Any dispute or controversy arising from the contract or transaction hereunder shall be submitted to the sole jurisdiction of the Court of Treviso, Italy.



Certification EU - ECOLABEL

The EU Ecolabel certification represents tangible and credible evidence of environmental excellence. In a context populated by acronyms and logos of all kinds, the EU Ecolabel qualifies products that have passed a rigid set of ecological compatibility criteria defined at EU community level. Based on the ISO 14024 standards, the EU Ecolabel is a basic reference for the evaluation of the most environmentally friendly cleaning products according to the logic of the National Green Public Procurement Action Plan (PAN GPP),

For TWT this step represents an important recognition and a logical extension of our long-term commitment to the environment. It is a guarantee to customers who with TWT are purchasing 100% ecological products, be they in textile or other materials (such as, for example, recycled plastic Re-Use trolleys).

We have decided to certify with the EU Ecolabel our MICRO COLOR Velcro flat mops, four of the flagship flat mops in our sales. We made it following a very demanding path verified by an external certification body, a process that was facilitated by the high quality standards that TWT already applies to its productions consistent to the criteria required by Ecolabel:

- non-use of materials and substances dangerous to health and to the environment (for example the presence of pesticides in cottons),
- limited air or water pollution during the production processes of the raw material as of the finished products,
- safety and resistance of products and colors to rubbing and to the exposure to atmospheric agents,
- resistance of the fabrics and limited shrinkage following washing and drying.

MICRO COLOR type flat mops are made with microfiber yarn to be very flexible and versatile. It combines, in a single product, the advantages of microfibre with the particular processing of the yarn. They are excellent in removing dirt and in absorbency thanks to the microfilaments of the microfiber; as well excellent is the dirt collection capacity thanks to the closed loop yarn.

MICRO COLOR is particularly suitable for use on smooth floors, specifically designed for use in healthcare, ho.re.ca, and food industry, it does not release lint and does not develop bacteria.

The differentiation of the color code for risk areas is carried out directly on the Velcro to prevent in a practical and immediate way any risk of incorrect application of the

colour differentiation in the implementation of the cleaning protocols. The use of non-shrinkable supports and the resistance of the yarn make it a champion of resistance with up to 1.000 washes.



Certification KIWA / ACCREDIA

TWT is **ISO 9001:2015** certified. This means that our quality system concerns all our management processes and the organization we implement to serve the market.

TWT srl is **ISO 14001:2015** certified. This confirms that the organization and the management system are adequate to keep the environmental impacts of the various company activities under control and systematically oriented to the improvement of environmental performances in an effective and sustainable way.

TWT srl is **SA 8000: 2014** certified. Specifically, the SA8000 standard identifies an international standard aimed at certifying certain aspects of business management, relating to corporate social responsibility, such as:

- Respect for human rights,
- Respect for workers' rights,
- Protection against the exploitation of minors,
- The guarantees of safety and health in the workplace.

This certification is required in order to participate in tenders.

MINISTRY OF HEALTH

MASK3000 is a Class I, Type IIR Medical Device (Reg. Ministry of Health 1990524)

It complies with the technical standards UNI EN 14683: 2019 - UNI EN ISO 10993-1: 2010 - UNI EN 14971: 2012 - UNI EN 1041: 2009 - UNI EN ISO 15223-1: 2012 and therefore meets all the requirements of efficacy and safety, even for prolonged use.



TWT Tools
Endless solutions



