

MA24



**mosmatic** 

**MASTER CATALOG**

**2024**

**CAR WASH | HIGH PRESSURE CLEANING | ROTARY UNIONS**



Mosmatic Corporation, Bristol, USA



Mosmatic Canada Inc., Saint-Léonard, CA



Mosmatic Australasia Pty Ltd., Coopers Plains, AU

## FOREWORD

We are proud to present the new Mosmatic customer catalogue. For your convenience we have combined our three divisions into one informative book. Car wash, high pressure cleaning and our high-precision swivel/rotary union lines can now be found in one catalogue. Mosmatic products are a brand of quality, reliability and performance that customers have come to expect as well as value in their daily applications.

It is our aim to continually provide you with products of highest quality at all stages: design, production and handling. Mosmatic produces high-precision components and accessories that cross a multitude of product applications and industries. Our focus is to produce efficient and reliable products that exceed customer expectations and industry standards.

To ensure our promise to quality we design, develop and manufacture all our products to ISO 9001:2015 standards.

Many of our products are within this catalogue or online at [www.mosmatic.com](http://www.mosmatic.com). For the latest information about our products, follow us on social media.

This catalogue was produced with attention to details to provide you valuable product information. However, as we continue to develop and design products there may be the possibility of printing or typing errors.

All data and measurements are without guarantees. We reserve the right to make technical modifications at any time without prior notification.

All rights reserved. Reproduction, in whole or in part, without our permission is not allowed.

Any Questions or concerns? Please do not hesitate to contact the Mosmatic team.

## ABOUT US

Mosmatic AG is a family owned and operated business that was founded in 1978. Our company name is put together of the first location of manufacture, a town named Mosnang, and the word automatic. (Mosnang Automatic + Mosmatic). After a few years of operation and growth our headquarters moved to a new and larger facility in Necker where we are still located today.

Mosmatic AG is a manufacturer based in Switzerland. For more than 40 years we successfully supply quality products for car wash industry, rotary unions and high pressure industries. At the place of the business we manufacture the entire range of our products and also handle a big part of the distribution of our global network.

Mosmatic is proud to process premium materials by using the latest technology machinery to produce high quality components and products. We market ready-made products for reselling and also offer customized solutions in state-of-the-art design. Reliability and the positive experience of using our products are due to continued improvements towards design, efficiency and durability.

Patrick Rieben (Managing Director):  
"For us Quality is not just a slogan, but the bench mark for our efforts, priorities and goals."



## GREEN LINE

Switzerland is one of the countries with the strictest environmental regulations worldwide. We are not just following those regulations but going beyond them. As manufacturer of rotary unions, car wash and high pressure equipment we are well aware of our responsibility towards nature. The green leaf represents our dedication towards the sustainability of Mosmatic products and processes.



Infographic as PDF



SN EN ISO 9001:2015 Certificate



|              |   |
|--------------|---|
| Welcome      | 2 |
| Index        | 3 |
| New Products | 4 |

**Car Wash**

|  |       |
|--|-------|
| Ceiling Boom Z-Series                          | 6     |
| Ceiling Boom Z-Series heated with LED Lighting | 7     |
| Ceiling Boom with LED Lighting                 | 8     |
| Ceiling Boom                                   | 9     |
| Dual Ceiling Boom                              | 10    |
| 1/2" Ceiling Boom 1/2" Wall Boom               | 11    |
| Wall-Boom                                      | 12    |
| Wall-Boom-Extension                            | 13    |
| Accessories Boom                               | 14    |
| Air-System Boom                                | 15    |
| Air-System Stand                               | 16    |
| Mosmatic Dryer                                 | 17    |
| Accessories Air System                         | 18    |
| Vertical Boom                                  | 19    |
| Bay-Packages                                   | 20    |
| Wand holder                                    | 21    |
| Brush Bucket                                   | 22    |
| HP-Wands                                       | 23    |
| Individual Wands                               | 24    |
| Wand with filter sleeve                        | 25    |
| Foam Products                                  | 26    |
| Foam Brushes                                   | 27    |
| Individual Foam Brushes                        | 28    |
| Flex-Brush Wand                                | 29    |
| Accessories Wash Bay                           | 30-31 |
| Wheelblaster                                   | 32    |
| Wheelblaster Compact                           | 33    |
| Wheelblaster Pro                               | 34    |
| Undercarriage Cleaner stationary               | 35    |
| Undercarriage Cleaner with Ramp                | 36    |
| Splash guard                                   | 37    |
| HP Guns  | 38    |

**High Pressure**

|                             |    |
|-----------------------------|----|
| Gum Remover                 | 40 |
| Professional                | 41 |
| Allrounder                  | 42 |
| Aqua                        | 43 |
| Aqua Pro                    | 44 |
| Graffiti Remover            | 45 |
| Contractor                  | 46 |
| Contractor Big              | 47 |
| Commercial                  | 48 |
| Universal                   | 49 |
| Steaminator                 | 50 |
| Hurricane Flip              | 51 |
| Hurricane                   | 52 |
| Hurricane Pro               | 53 |
| Roof Cleaner                | 54 |
| Surface Cleaner Upgrade Kit | 55 |
| Duct Cleaner                | 56 |
| TRL Wand                    | 57 |
| HP Special Wand             | 57 |
| Manhole Cleaner             | 58 |
| Silo Cleaner                | 58 |
| Spider                      | 59 |
| Spider adjustable           | 60 |
| Rotor arms                  | 61 |
| Nozzles                     | 62 |
| Turbo Nozzles               | 63 |
| Accessories HP Cleaner      | 64 |

**Rotary Unions**

|                               |       |
|-------------------------------|-------|
| Select by application         | 66    |
| Select by construction type   | 67    |
| DGV - Swivels                 | 68    |
| DGVI - Swivels                | 69    |
| DGW - Swivels                 | 70-71 |
| DGS - Swivels                 | 72    |
| DKS - Swivel Couplings        | 73    |
| DGE - Swivels                 | 74    |
| DGEI - Swivels                | 75    |
| DGR - Swivels                 | 76    |
| WDE - Swivels                 | 77    |
| WDEI - Swivels                | 78    |
| WDG - Swivels                 | 79    |
| WDB - Swivels                 | 80    |
| WDC - Swivels                 | 81    |
| WDRS - Swivels                | 82    |
| DGL - Swivels                 | 83    |
| DGS - Swivels                 | 84    |
| DGF - Swivels                 | 85    |
| DXL - Swivels                 | 86    |
| DXLS/DXGS/DXFS Steam Swivels  | 87    |
| DXG - Swivels                 | 88    |
| DXF - Swivels                 | 89    |
| DXTI - Swivels                | 90    |
| DYL - Swivels                 | 91    |
| DYG - Swivels                 | 92    |
| DVF - Swivels                 | 93    |
| DYW - Swivels                 | 94    |
| DYCI/DYDI - Swivels           | 95    |
| DYTI/DYU - Swivels            | 96    |
| DYKI - Swivels                | 97    |
| QVS - Quick Connections       | 98    |
| Fittings                      | 99    |
| Adaptor with Sieve            | 100   |
| HP couplings                  | 100   |
| Customer Inquiry Rotary Union | 101   |
| Terms and Conditions of Sale  | 102   |



Ceiling Boom Z-Series heated with LED lighting - Page 7

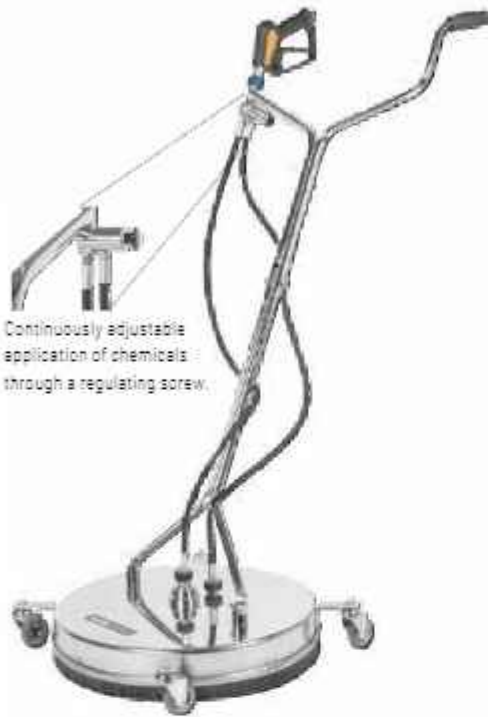

Continuously adjustable application of chemicals through a regulating screw.

Commercial e520 with low pressure option - Page 48



Undercarriage Cleaner with Ramp new with high performance pump and hose kit - Page 35

UPGRADES & ADDITIONS



Mosmatic Dryer - Page 17



2 1/2\" WDRS Swivels - Page 82



2 1/2\" DGR Swivels - Page 76



WDEI Swivels - Page 78



Stabilizer nozzle - Page 31



Rotor Nozzle MOSjet - Page 63



HP Wands and HP Special Wands - Page 23 / Page 57

**Our goal:**

**To provide products that have appearance and performance alike, offering value to you and your customer.**

# CAR WASH

## **Mosmatic Self-Service Car Wash**

As the inventor of the Z-Ceiling booms, Mosmatic's innovations have helped to develop the most diverse line of ceiling and wall booms available today. The uniform appearance of the complete line along with their unsurpassed durability and ease of operation have made us the top choice and go to company for industrial and business professionals alike. Mosmatic's focus has always been to design, build and sell only the best products on the market.



## **Automatic Car and Tunnel Washes**

OEM's, service technicians and business owners know they can trust and rely on the quality of Mosmatic products. Designed to handle, and withstand the harsh wash environment, our products have proven they can and will perform to the highest standards. From concept, design and system upgrades let us be the number one source for you.



## **Commercial Vehicle Wash**

Industrial, performance grade solutions for the most demanding washes. From wheel washers, to undercarriage and those odd long distance hard to reach areas Mosmatic offers solutions to accommodate your needs. From smaller low volume applications to much larger high volume washes, our component selection is sure to have something to fit your needs.



## **Accessories**

Marketing and name brands, combined with reliable quality products, show your customers that you are not only a provider but a partner in the industry.





# CEILING BOOM Z-SERIES



- ✓ 360° smooth rotation rated to 4000 psi
- ✓ Rated to 4000 psi
- ✓ Multiple booms with center rotation points
- ✓ Polished stainless steel (INOX)
- ✓ Clean and classic appearance

The ideal solution for self-service car washes. The unique shape of Mosmatic Z-Booms allows the installation of multiple ceiling booms in one wash bay. This makes it possible to add profitable services such as foam applications and Air Drying to your existing programs.



### DKZ

| Part No. | L   | A       | B   | C   | D   | Weight |
|----------|-----|---------|-----|-----|-----|--------|
| 65.998   | 29" | 8"      | 22" | 31" | 18" | 15 lbs |
| 65.999   | 40" | 11 1/2" | 29" | 45" | 23" | 18 lbs |
| 65.009   | 49" | 14"     | 34" | 55" | 28" | 22 lbs |
| 65.019   | 51" | 15"     | 35" | 59" | 30" | 23 lbs |
| 65.029   | 55" | 16"     | 38" | 63" | 32" | 24 lbs |
| 65.039   | 59" | 17"     | 40" | 67" | 34" | 26 lbs |

Part No. includes one ceiling boom.

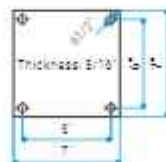
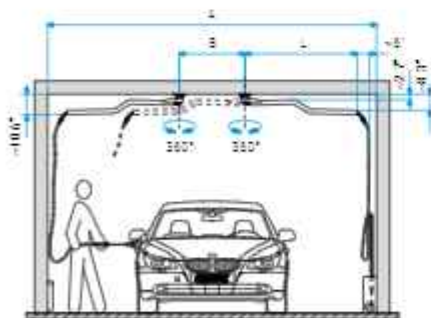

Bearable load for each boom at least: 30.000 lb (for example 1/2 boom)

### TECHNICAL DATA

|                    |                                     |
|--------------------|-------------------------------------|
| Pressure           | 4000 psi (27.5 MPa)                 |
| Temperature        | 250°F                               |
| Inlet (top & side) | 3/8" NPTF (other options available) |
| Outlet             | 3/8" NPTF (other options available) |
| Throughput medium  | water, oil, air at pH 3-12          |

environmentally friendly products

Dual Set-up

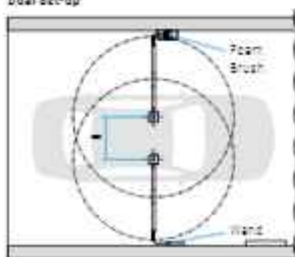

Triple Set-up\*

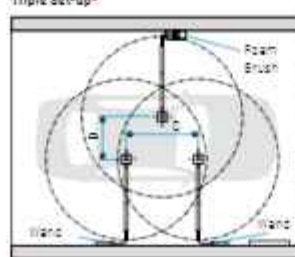

Triple Set-up

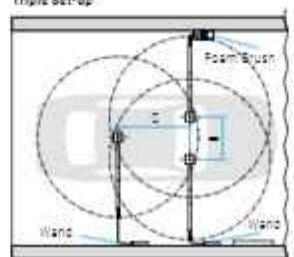

Quadruple Set-up

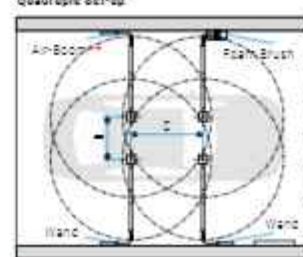

\* not suitable for mounting bracket 65.903

\*\* in conjunction with air boom DKZ booms must be extended with part no. 902.755

### Legend

M. = metric thrust, M = male, F = female, B = gas side thrust, R = gas side thrust optional, QV = quick connects, SV = profiling fitting, D = diameter, L = length, NW = nominal width, SW = wrench size, IN = male input, OUT = male output, RB = basic position

# CEILING BOOM Z-SERIES HEATED WITH LED LIGHTING



- ✓ No freezing of the medium in the ceiling boom
- ✓ Heated ceiling boom with HP-Hose
- ✓ Save water in winter
- ✓ 14' HP-Hose Comfort included
- ✓ 360° smooth rotation
- ✓ Visualize the wash cycles or heating

With the Ceiling Boom Z-Series Heated with LED Lighting from Mosmatic, freezing of the medium in the cold season is a thing of the past. Thanks to the heating cable that extends from the ceiling boom to the wand or gun, the medium is heated continuously. The constant flow of water to prevent freezing can thus be reduced to a minimum. The Ceiling Boom Z-Series Heated with LED Lighting from Mosmatic can be easily integrated into existing systems without the need for additional construction. The only requirement is a power connection. Additionally, it offers all the advantages of the proven Ceiling Boom Z-Series with LED Lighting.



### DKZel

| Part No. | L    | A   | B   | C   | D   | Weight |
|----------|------|-----|-----|-----|-----|--------|
| 65.109   | 4'9" | 14" | 34" | 55" | 28" | 24 lbs |
| 65.119   | 5'1" | 15" | 35" | 59" | 30" | 25 lbs |

Part No. includes one ceiling boom and one HP-Hose Comfort

HP-Hose length 14'

Heating cable sticks out 4" at the end of the hose

More information on request.

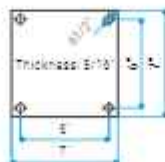
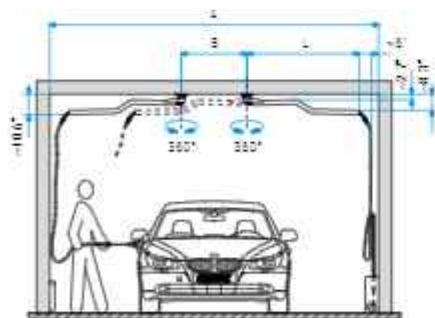

Bearable load for each boom at least: 30.000 lb (for example 1/2" bolts)

### TECHNICAL DATA

|                    |                                     |
|--------------------|-------------------------------------|
| Pressure           | 1500 psi (10 MPa)                   |
| Temperature        | 140°F                               |
| Inlet (top & side) | 3/8" NPTF (other options available) |
| Outlet             | 3/8" NPTM                           |
| Operating voltage  | 24V                                 |
| Throughput medium  | water, oil, air at pH 3-12          |

environmentally friendly products

Dual Set-up

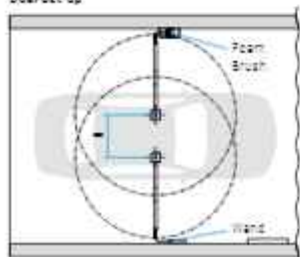

Triple Set-up\*

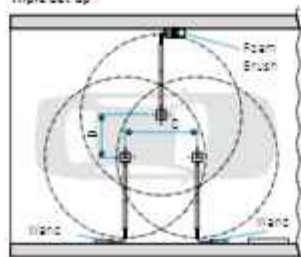

Triple Set-up

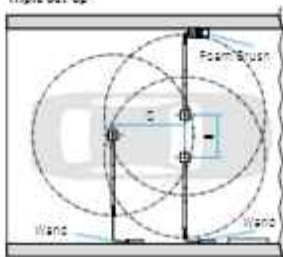

Quadruple Set-up

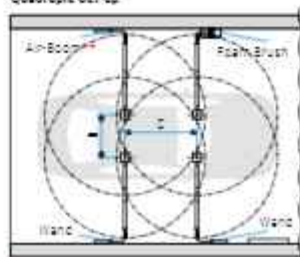

\* not suitable for mounting bracket 65.903

\*\* in conjunction with air boom DKZ booms must be extended with part no. 902.755

### Legend

M. = metric thrust, .M = male, F = female, B = gas pipe thrust, R = gas pipe thrust control, QV = quick connects, SV = profile ring fitting, D = diameter, L = length, NW = nominal width, SW = wrench size, IN = male input, OUT = male output, RG = basic position

- ✓ Modern visual effects
- ✓ Visualize the wash cycles
- ✓ Additional lighting for the wash bay
- ✓ Stand out above competition

The world's first for the self-service car wash. The LED Boom can be synchronized with your wash cycle to visualize your wash program. The LED ceiling boom is not only an eye-catcher for self-service car washes, but also provides additional lighting for the bay adding safety for your clients. This product should be installed by a certified electrician.



### DKZbl (without Control Box)

| Part No. | L   | A   | B   | Weight |
|----------|-----|-----|-----|--------|
| 65.209   | 49" | 14" | 34" | 23 lbs |
| 65.219   | 51" | 15" | 36" | 24 lbs |
| 65.229   | 53" | 16" | 38" | 25 lbs |
| 65.239   | 59" | 17" | 40" | 27 lbs |

Part No. includes one ceiling boom.



### DKPbl (without Control Box)

| Part No. | L   | Weight   |
|----------|-----|----------|
| 66.209   | 49" | 21.2 lbs |
| 66.219   | 53" | 21.8 lbs |
| 66.229   | 59" | 22.5 lbs |
| 66.239   | 59" | 23.1 lbs |
| 66.249   | 59" | 23.8 lbs |

| Part No. | L     | Weight   |
|----------|-------|----------|
| 66.259   | 76"   | 24.5 lbs |
| 66.269   | 82"   | 25.1 lbs |
| 66.279   | 9'    | 25.8 lbs |
| 66.289   | 9'10" | 26.5 lbs |

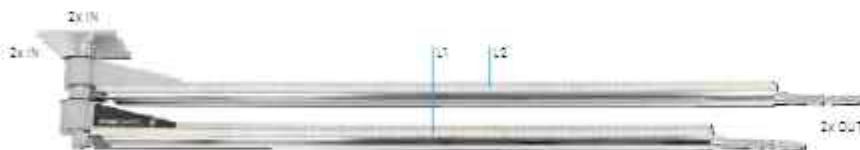

### DDPbl (without Control Box)

| Part No. | L1  | L2  | Weight   |
|----------|-----|-----|----------|
| 67.609   | 49" | 53" | 41.0 lbs |
| 67.619   | 53" | 59" | 41.7 lbs |
| 67.629   | 59" | 63" | 42.3 lbs |
| 67.639   | 63" | 69" | 43.0 lbs |
| 67.649   | 69" | 76" | 43.7 lbs |
| 67.659   | 76" | 82" | 45.5 lbs |

When using high and low pressure, we recommend to connect the low pressure to the upper boom.

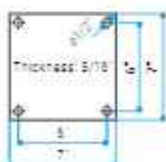

Sealside load for each bore at least 30 000 N (for example 1/2" bore)

### Energy ring connection

| Color  | Voltage     | Feature               |
|--------|-------------|-----------------------|
| Black  | positiv (+) | Power supply          |
| Red    | negativ (-) | controls red signal   |
| Orange | negativ (-) | controls green signal |
| Brown  | negativ (-) | controls blue signal  |



### LED-Control Box

| Part No. | Includes  |
|----------|---|
| 65.975   | Controller, power supply, remote control, receiver with housing, for maximum 2x booms |

### TECHNICAL DATA

|                    |                                     |
|--------------------|-------------------------------------|
| Pressure           | 4000 psi (27,5 MPa)                 |
| Temperature        | 250°F                               |
| Inlet (top & side) | 3/8" NPTF (other options available) |
| Outlet             | 3/8" NPTF (other options available) |
| Operating voltage  | 24V                                 |
| Light intensity    | 120 lx                              |
| Amount             | 30 x LED/39"                        |
| IP Code            | IP66                                |
| Throughput medium  | water, oil, air at pH 3-12          |

environmentally friendly products

#### Legend

M. = metric thrust, L.M = male, F = female, B = gas pipe thrust, R = gas pipe thrust control, QV = quick connects, SV = profile ring fitting  
 D = diameter, L = length, NW = nominal width, SW = wrench size, IN = male input, OUT = male output, RB = basic position



- ✓ 360° smooth rotation
- ✓ Rated to 4000 psi
- ✓ Sealed bearing design
- ✓ Multiple industrial application

The classic straight ceiling boom has uses in many industrial fields. A few examples are car wash, food processing, mining and manufacturing. A real all-around product with versatile applications anywhere liquids, air or gas are used.



### DKP

| Part No. | L    | Weight   | Part No. | L     | Weight   |
|----------|------|----------|----------|-------|----------|
| 66.976   | 2'9" | 18 lbs   | 66.049   | 8'9"  | 24 lbs   |
| 66.951   | 4'0" | 19.5 lbs | 66.059   | 7'5"  | 24.5 lbs |
| 66.009   | 4'9" | 21 lbs   | 66.069   | 8'2"  | 25 lbs   |
| 66.019   | 5'3" | 22 lbs   | 66.079   | 9'    | 26 lbs   |
| 66.029   | 5'9" | 22.5 lbs | 66.089   | 9'10" | 27 lbs   |
| 66.039   | 6'3" | 23 lbs   | 66.099   | 10'0" | 39.5 lbs |



### DP2 (two separate mediums in one ceiling boom)

| Part No. | L    | Weight   | Part No. | L     | Weight   |
|----------|------|----------|----------|-------|----------|
| 66.451   | 4'9" | 24 lbs   | 66.456   | 7'5"  | 27.5 lbs |
| 66.452   | 5'3" | 25 lbs   | 66.457   | 8'2"  | 28 lbs   |
| 66.453   | 5'9" | 25.5 lbs | 66.458   | 9'    | 29 lbs   |
| 66.454   | 6'3" | 26 lbs   | 66.459   | 9'10" | 30 lbs   |
| 66.455   | 6'9" | 27 lbs   |          |       |          |



Supportable load for each bore at least 50 000 N (for example 1/2" bore)

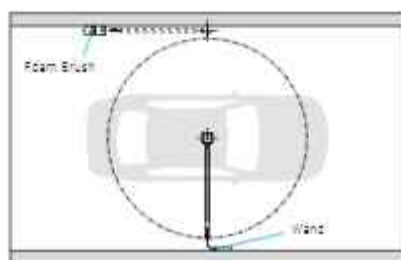
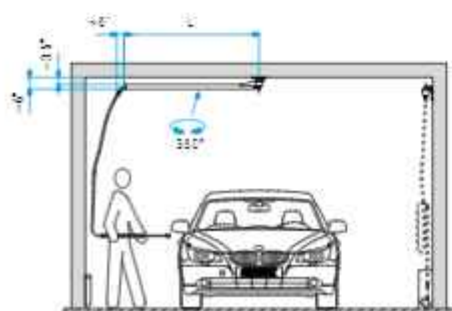

### TECHNICAL DATA

|                    |                                     |
|--------------------|-------------------------------------|
| Pressure           | 4000 psi (27.5 MPa)                 |
| Temperature        | 250°F                               |
| Inlet (top & side) | 3/8" NPTF (other options available) |
| Outlet             | 3/8" NPTF (other options available) |
| Throughput medium  | water, oil, air at pH 3-12          |

environmentally friendly products

### Legend

M. = metric thrust, .M = male, F = female, B = gas pipe thrust, R = gas pipe thrust control, QV = quick connect, SV = profile ring fitting, D = diameter, L = length, NW = nominal width, SW = wrench size, IN = media input, OUT = media output, RG = basic position

# DUAL CEILING BOOM



- ✓ A classic for the prep station
- ✓ Delivered ready for installation
- ✓ 2x 360° booms on one stem

The dual ceiling boom is commonly installed as tunnel prep, detail or feet wash applications. This is the area where they are most frequently used. If used in a self-service car wash, we recommend to connect the foam brush to the upper boom and the high pressure wand to the lower boom.

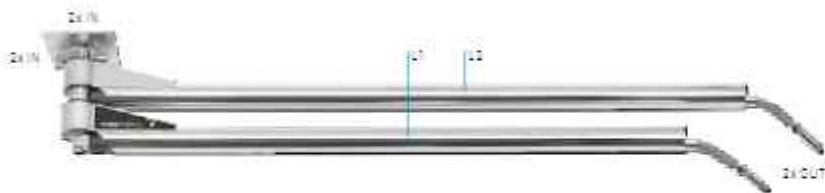

When using high and low pressure, we recommend to connect the low pressure to the upper boom.

## DDP

| Part No. | L1  | L2  | Weight |
|----------|-----|-----|--------|
| 67.409   | 49" | 53" | 39 lbs |
| 67.419   | 53" | 59" | 41 lbs |
| 67.429   | 59" | 63" | 42 lbs |
| 67.439   | 63" | 69" | 44 lbs |
| 67.449   | 69" | 75" | 46 lbs |
| 67.459   | 75" | 82" | 48 lbs |

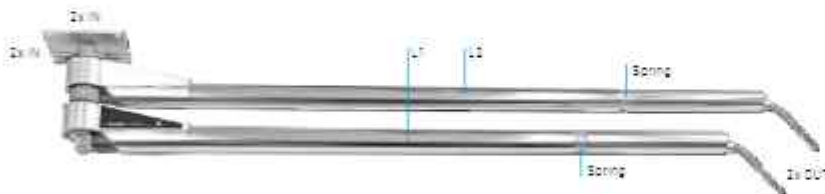

When using high and low pressure, we recommend to connect the low pressure to the upper boom.

## DDF (with flex-arm)

| Part No. | L1  | L2  | Weight |
|----------|-----|-----|--------|
| 63.409   | 49" | 53" | 40 lbs |
| 63.419   | 53" | 59" | 41 lbs |
| 63.429   | 59" | 63" | 43 lbs |
| 63.439   | 63" | 69" | 45 lbs |
| 63.449   | 69" | 73" | 49 lbs |
| 63.459   | 75" | 82" | 52 lbs |

WWW.MOSMATIC.COM

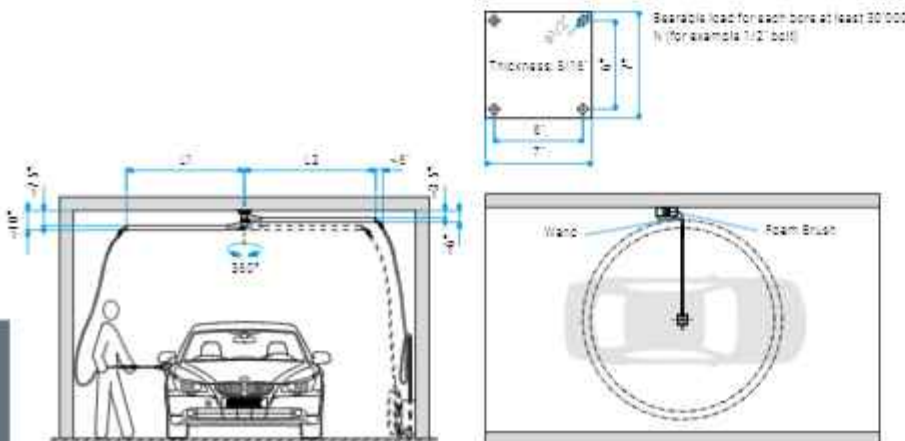

## TECHNICAL DATA

|                    |                                     |
|--------------------|-------------------------------------|
| Pressure           | 4000 psi (27,5 MPa)                 |
| Temperature        | 250°F                               |
| Inlet (top & side) | 3/8" NPTF (other options available) |
| Outlet             | 3/8" NPTF (other options available) |
| Throughput medium  | water, oil, air at pH 3-12          |

environmentally friendly products

### Legend

M. = metric thread, .M = male, F = female, Ø = gas pipe thread, R = gas pipe thread conical, QV = quick connects, SV = profile ring fitting, D = diameter, L = length, NW = nominal width, SW = wrench size, IN = male inlet, OUT = male outlet, RB = basic position



# 1/2" CEILING BOOM 1/2" WALL BOOM

- ✓ 180°/360° smooth rotation
- ✓ High flow version
- ✓ 1/2" nominal width
- ✓ Sealed bearing design
- ✓ Multiple industrial applications

The classic straight ceiling boom is used in many industrial fields. A few examples are truck wash, food processing, mining and manufacturing. A real all-around product with versatile applications anywhere liquids, air or gas are used.

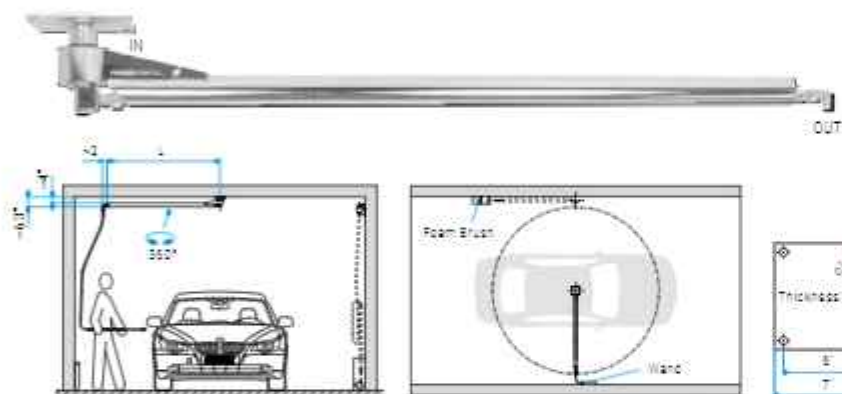

### DKP 1/2" (with INOX-Pipe)

| Part No. | L    | Weight   | Part No. | L     | Weight   |
|----------|------|----------|----------|-------|----------|
| 66.421   | 4'9" | 22.4 lbs | 66.426   | 7'5"  | 27.3 lbs |
| 66.422   | 5'3" | 23.4 lbs | 66.427   | 8'2"  | 28.3 lbs |
| 66.423   | 5'9" | 24.4 lbs | 66.428   | 9'    | 29.3 lbs |
| 66.424   | 6'3" | 25.4 lbs | 66.429   | 9'10" | 30.3 lbs |
| 66.425   | 6'9" | 26.3 lbs |          |       |          |

Bearable load for each bore at least:  
30 000 N (for example 1/2" bore)

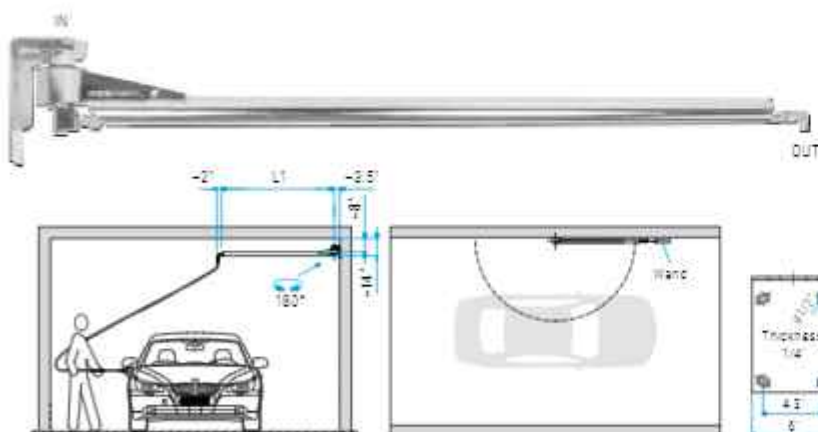

### WAE 1/2" (with INOX-Pipe)

| Part No. | L    | Weight   | Part No. | L     | Weight   |
|----------|------|----------|----------|-------|----------|
| 68.421   | 4'9" | 23.0 lbs | 68.426   | 7'5"  | 28.0 lbs |
| 68.422   | 5'3" | 24.0 lbs | 68.427   | 8'2"  | 29.0 lbs |
| 68.423   | 5'9" | 25.0 lbs | 68.428   | 9'    | 30.0 lbs |
| 68.424   | 6'3" | 26.0 lbs | 68.429   | 9'10" | 31.0 lbs |
| 68.425   | 6'9" | 27.0 lbs |          |       |          |

Bearable load for each bore at least:  
30 000 N (for example 1/2" bore)

### TECHNICAL DATA

|                     |                                     |
|---------------------|-------------------------------------|
| Pressure            | 2200 psi (15 MPa)                   |
| Temperature         | 250°F                               |
| Inlet (top or side) | 1/2" NPTF (other options available) |
| Outlet              | 1/2" NPTF (other options available) |
| Throughput medium   | water, oil, air at pH 3-12          |

environmentally friendly products

### Legend

M = metric thread, ...M = male, F = female, B = gas pipe thread, R = gas pipe thread conical, DV = quick connect, SV = profile ring fitting  
D = diameter, L = length, NW = nominal width, SW = wrench size, IN = male input, OUT = male output, RG = basic position

- ✓ 180° smooth rotation
- ✓ Insulated HP-hose
- ✓ Multiple industry application

Wall-mounted booms are ideal for outdoor areas or in wash bays where ceiling mounts are not an option. The wall bracket is designed for the boom to return to the resting position you selected.



### WAE (with HP-hose)

| Part No. | L     | Weight |
|----------|-------|--------|
| 68.509   | 4'9"  | 22 lbs |
| 68.519   | 5'3"  | 24 lbs |
| 68.529   | 5'9"  | 24 lbs |
| 68.539   | 6'3"  | 24 lbs |
| 68.549   | 6'9"  | 25 lbs |
| 68.559   | 7'5"  | 26 lbs |
| 68.569   | 8'2"  | 27 lbs |
| 68.579   | 9'    | 29 lbs |
| 68.589   | 9'10" | 31 lbs |

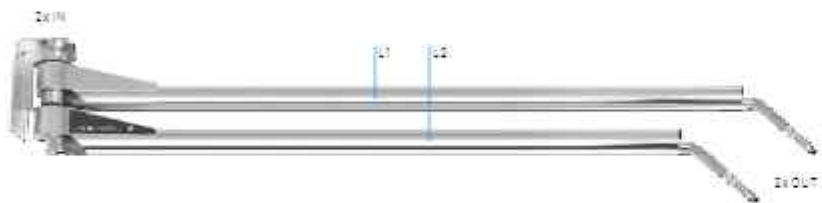

### WAD

| Part No. | L1   | L2   | Weight |
|----------|------|------|--------|
| 61.409   | 5'3" | 4'9" | 42 lbs |
| 61.419   | 5'9" | 5'3" | 43 lbs |
| 61.429   | 6'3" | 5'9" | 43 lbs |
| 61.439   | 6'9" | 6'3" | 44 lbs |
| 61.449   | 7'5" | 6'9" | 45 lbs |
| 61.459   | 8'2" | 7'5" | 46 lbs |

When using high and low pressure, use upper boom for low pressure.

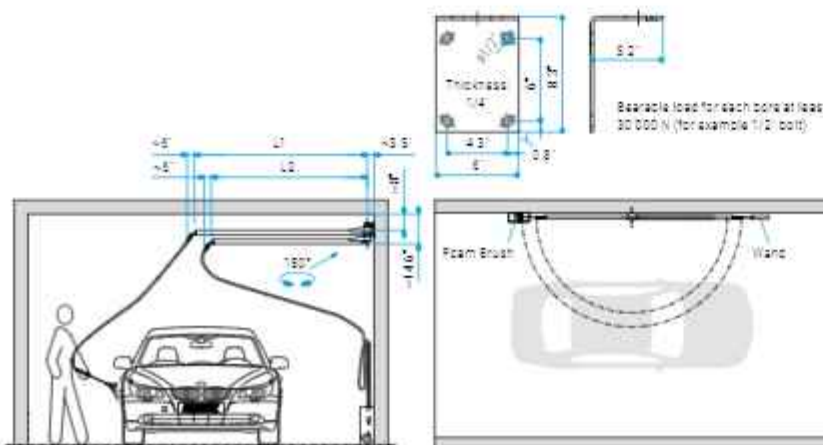

### TECHNICAL DATA

|                    |                                     |
|--------------------|-------------------------------------|
| Pressure           | 4000 psi (27,5 MPa)                 |
| Temperature        | 250°F                               |
| Inlet (top & side) | 3/8" NPTF (other options available) |
| Output             | 3/8" NPTF (other options available) |
| Throughput medium  | water, oil, air at pH 3-12          |

environmentally friendly products

#### Legend

M... = metric thrust, ...M = male, F = female, B = gas side thrust, R = gas side thrust optional, QV = quick connects, SV = profile ring fitting, D = diameter, L = length, NW = nominal width, SW = wrench size, IN = male inlet, OUT = male outlet, RB = basic position



- ✓ Smooth, comfortable operation
- ✓ Extended work radius
- ✓ Solid construction

Whenever extended lengths and maximum flexibility are required, the wall-boom-extension is perfect for the job. Prime examples are truck wash bays, mining facilities, air craft maintenance and manufacturing plants. When combined correctly, a working radius of 39' is possible.



### WSA (1 inner pipe + 1 inlet)

| Part No. | B     | L max. | Weight  |
|----------|-------|--------|---------|
| 60.522   | 6'8"  | 6'3"   | 53 lbs  |
| 60.532   | 8'2"  | 7'5"   | 56 lbs  |
| 60.542   | 9'10" | 9'     | 63 lbs  |
| 60.983   | 14'9" | 9'10"  | 114 lbs |
| 60.930   | 19'6" | 19'8"  | 127 lbs |

Add ceiling boom: DKP



### WSA-2R (2 inner pipes + 2 inlets)

| Part No. | B     | L max. | Weight |
|----------|-------|--------|--------|
| 60.910   | 6'8"  | 6'3"   | 55 lbs |
| 60.911   | 8'2"  | 7'5"   | 60 lbs |
| 60.912   | 9'10" | 9'     | 65 lbs |

Add ceiling boom: DP2

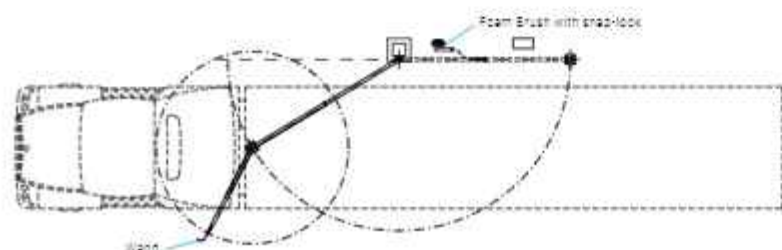
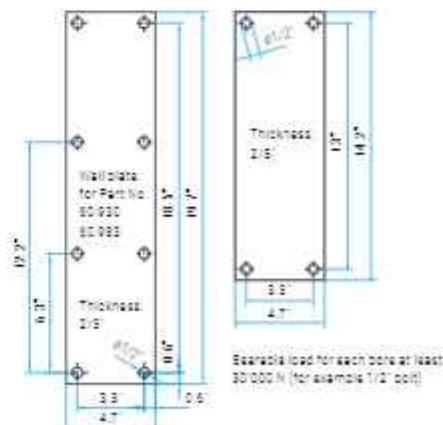
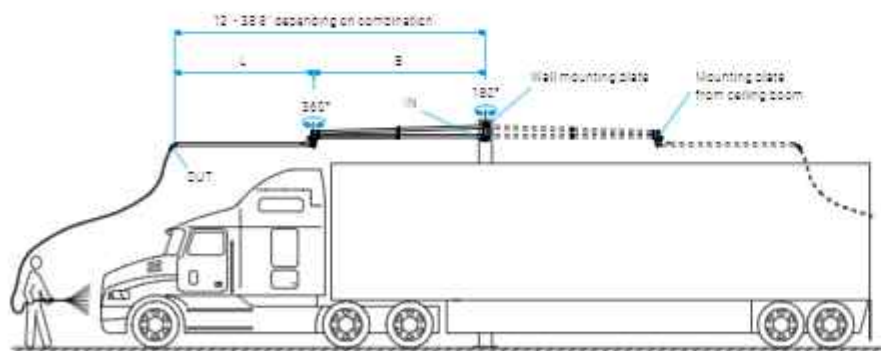



### TECHNICAL DATA

|                   |                                     |
|-------------------|-------------------------------------|
| Pressure          | 4000 psi (27.5 MPa)                 |
| Temperature       | 250°F                               |
| Inlet (bottom)    | 3/8" NPTF (other options available) |
| Outlet            | 3/8" NPTM (other options available) |
| Throughput medium | water, oil, air at pH 3-12          |

### Legend

M. = metric thrust, ...M = male, F = female, B = gas pipe thrust, R = gas pipe thrust control, QV = quick connect, SV = profile ring fitting, D = diameter, L = length, NW = nominal width, SW = insertion size, IN = male input, OUT = male output, RG = basic position

|  |                            |                           |   |
|--|----------------------------|---------------------------|---|
| <b>Axle Extension</b><br>for ceiling booms, stainless steel<br>extended by 30" | <b>Part No.</b><br>902.293 | <b>Weight</b><br>35.6 lbs |  |
|--|----------------------------|---------------------------|---|

|   |                           |                          |   |
|---|---------------------------|--------------------------|---|
| <b>Bracket</b><br>with bumpers, stainless steel, for<br>WAE | <b>Part No.</b><br>68.952 | <b>Weight</b><br>3.3 lbs |  |
|---|---------------------------|--------------------------|---|

|   |                           |                          |   |
|---|---------------------------|--------------------------|---|
| <b>Break-Away Fitting</b><br>IN 3/8" NPTM, OUT 3/8" NPTF<br>3800 psi, brass nickel plated | <b>Part No.</b><br>52.903 | <b>Weight</b><br>0.2 lbs |  |
| IN R1/4" M, OUT G1/4" F<br>3800 psi, brass nickel plated                                  | <b>Part No.</b><br>52.904 | <b>Weight</b><br>0.2 lbs |   |
| IN R3/8" M, OUT G3/8" F<br>3800 psi, brass nickel plated                                  | <b>Part No.</b><br>52.905 | <b>Weight</b><br>0.2 lbs |   |

|                                  |                           |                           |   |
|----------------------------------|---------------------------|---------------------------|---|
| <b>Bumper</b><br>for boom, ø2.4" | <b>Part No.</b><br>65.989 | <b>Weight</b><br>0.02 lbs |  |
|----------------------------------|---------------------------|---------------------------|---|

|   |                            |                           |   |
|---|----------------------------|---------------------------|---|
| <b>Extension</b><br>for ceiling booms, stainless steel<br>extends by 2' | <b>Part No.</b><br>902.753 | <b>Weight</b><br>9.5 lbs  |  |
| for ceiling booms, stainless steel<br>extends by 4'                     | <b>Part No.</b><br>902.752 | <b>Weight</b><br>11.2 lbs |   |
| for ceiling booms, stainless steel<br>extends by 8'                     | <b>Part No.</b><br>901.875 | <b>Weight</b><br>14.5 lbs |   |
| for ceiling booms, stainless steel<br>extends by 16'                    | <b>Part No.</b><br>901.876 | <b>Weight</b><br>22.0 lbs |   |

|   |                 |               |  |
|---|-----------------|---------------|--|
| <b>HP-Hose</b><br>NW 3/8", standard car wash hose | <b>Part No.</b> | <b>Weight</b> |  |
| 4', IN 3/8" NPTM, OUT 3/8" NPTM                   | 90.073          | 0.9 lbs       |  |
| 15', IN 3/8" NPTM, OUT 3/8" NPTM                  | 90.074          | 3.9 lbs       |  |
| 20', IN 3/8" NPTM, OUT 3/8" NPTM                  | 90.075          | 4.6 lbs       |  |

|  |                 |               |   |
|--|-----------------|---------------|---|
| <b>HP-Hose Comfort</b><br>NW 1/4" or 3/8", lightweight<br>construction, inner core PES | <b>Part No.</b> | <b>Weight</b> |  |
| 14', IN 3/8" NPTM, OUT 3/8" NPTM   | 90.088          | 1.2 lbs       |   |
| 12', IN 3/8" NPTM, OUT 3/8" NPTM   | 90.089          | 1.0 lbs       |   |
| 16', IN 3/8" NPTM, OUT 3/8" NPTM   | 90.090          | 1.2 lbs       |   |
| 11', IN 1/4" NPTM, OUT 1/4" NPTM   | 90.092          | 0.9 lbs       |   |
| 18', IN 1/4" NPTM, OUT 1/4" NPTM   | 90.093          | 1.3 lbs       |   |
| 14', IN 3/8" NPTM, OUT 3/8" NPTM*  | 90.098          | 1.2 lbs       |   |

|  |                           |                          |   |
|--|---------------------------|--------------------------|---|
| <b>LED-Control Box</b><br>for maximum 2x booms<br>Includes: Controller, power supply,<br>remote control, receiver with housing | <b>Part No.</b><br>65.975 | <b>Weight</b><br>1.3 lbs |  |
|--|---------------------------|--------------------------|---|

|  |                           |                           |   |
|--|---------------------------|---------------------------|---|
| <b>Mounting Bracket</b><br>for DKZ, stainless steel<br>47" (9' (2" (L/W/H) | <b>Part No.</b><br>65.903 | <b>Weight</b><br>29.0 lbs |  |
| for DKZ, stainless steel<br>75" (9' (2" (L/W/H)                            | <b>Part No.</b><br>65.988 | <b>Weight</b><br>46.3 lbs |   |

|   |                           |                          |   |
|---|---------------------------|--------------------------|---|
| <b>Positioning Device</b><br>ø2" with magnet, height adjustable | <b>Part No.</b><br>65.952 | <b>Weight</b><br>2.0 lbs |  |
| ø2.4" with magnet, height adjustable                            | <b>Part No.</b><br>65.911 | <b>Weight</b><br>2.0 lbs |   |

|  |                           |                          |   |
|--|---------------------------|--------------------------|---|
| <b>Three Way Valve</b><br>for DP2,<br>IN 2x 3/8" NPTF, OUT 3/8" NPTF | <b>Part No.</b><br>90.065 | <b>Weight</b><br>1.3 lbs |  |
|--|---------------------------|--------------------------|---|

|   |                           |                          |   |
|---|---------------------------|--------------------------|---|
| <b>Wall Bracket Universal</b><br>for ceiling booms, stainless steel | <b>Part No.</b><br>65.940 | <b>Weight</b><br>5.6 lbs |  |
|---|---------------------------|--------------------------|---|



- ✓ 180° or 360° smooth rotation
- ✓ Top, bottom or side port connections
- ✓ Can be combined with other Mosmatic booms
- ✓ For use with air dryers or vacuum systems

Using Mosmatic Air-System Booms will not only keep your hoses off the ground, but stops the customer from dragging wet and dirty hoses onto their vehicles. Available in: wall, floor or ceiling mount. For use with a vacuum or Mosmatic Air-Dry.



### LU-DZ (Air-boom +Z+ for ceiling installation)

| Part No. | L    | ø  | Connection | Weight |
|----------|------|----|------------|--------|
| 60.324   | 5'1" | 2" | side       | 19 lbs |
| 60.326   | 5'1" | 2" | top        | 18 lbs |

Part No. includes one boom.



### LU-D (Air-boom straight, for ceiling installation)

| Part No. | L    | ø    | Connection | Weight |
|----------|------|------|------------|--------|
| 60.301   | 5'3" | 1.5" | side       | 17 lbs |
| 60.306   | 5'3" | 1.5" | top        | 18 lbs |
| 60.310   | 5'3" | 2"   | side       | 17 lbs |
| 60.313   | 5'3" | 2"   | top        | 18 lbs |



### LU-W (Air-boom straight, for wall installation)

| Part No. | L    | ø    | Connection | Weight |
|----------|------|------|------------|--------|
| 60.302   | 5'3" | 1.5" | bottom     | 17 lbs |
| 60.311   | 5'3" | 2"   | bottom     | 18 lbs |
| 60.925   | 3'8" | 1.5" | bottom     | 15 lbs |

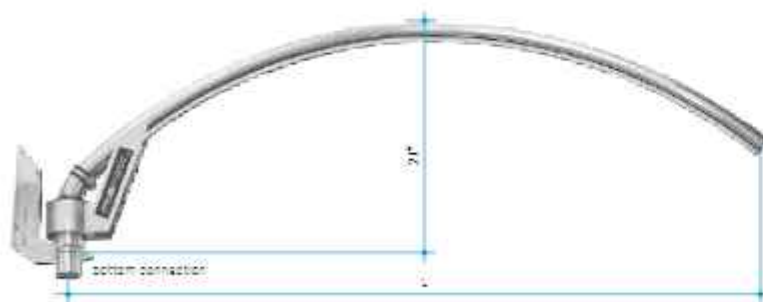

### LU-WB (Air-boom curved, for wall installation)

| Part No. | L    | ø  | Connection | Weight |
|----------|------|----|------------|--------|
| 60.958   | 5'7" | 2" | bottom     | 19 lbs |

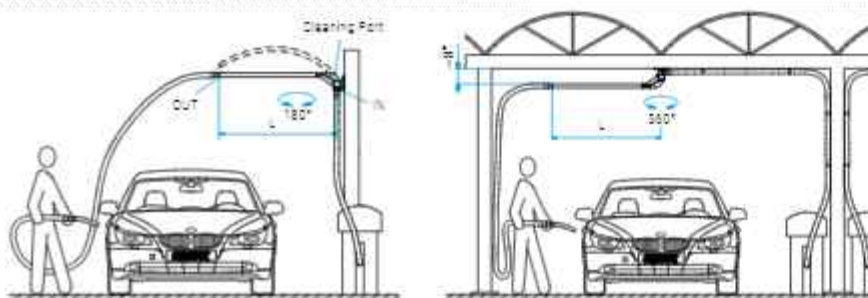

#### LU-D / LU-DZ:



#### LU-W / LU-WB:

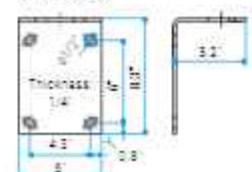

Support load for each pore at least: 30.000 N (for example 1/2" bore).

#### Legend

M. = metric thrust, .M = male, F = female, B = gas pipe thrust, R = gas pipe thrust control, QV = quick connect, SV = profile ring fitting, Ø = diameter, L = length, NW = nominal width, SW = insertion size, IN = male input, OUT = male output, RB = basic position

# AIR-SYSTEM STAND

- ✓ 180° or 360° smooth rotation
- ✓ Polished stainless steel
- ✓ Solid construction
- ✓ Ideal for vacuum islands



Mosmatic free standing floor mounted air-booms allow you the convenience of placing your boom where you need it. Choose between a 180° or 360° rotation.

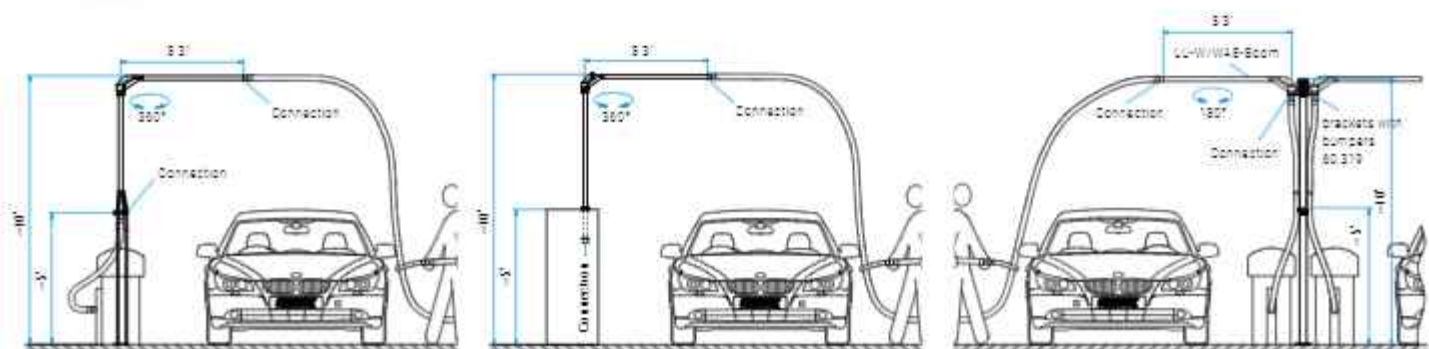
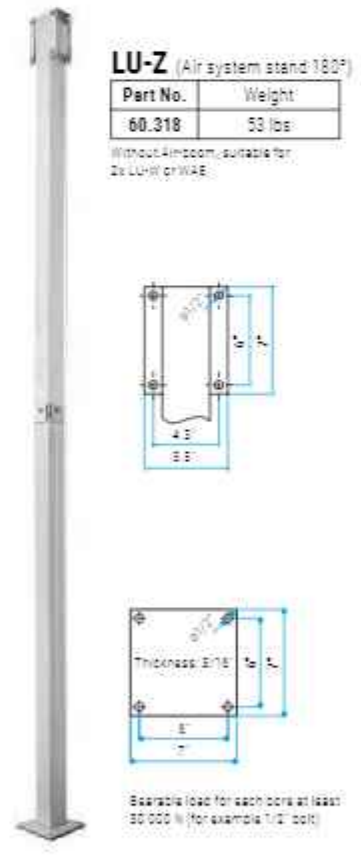
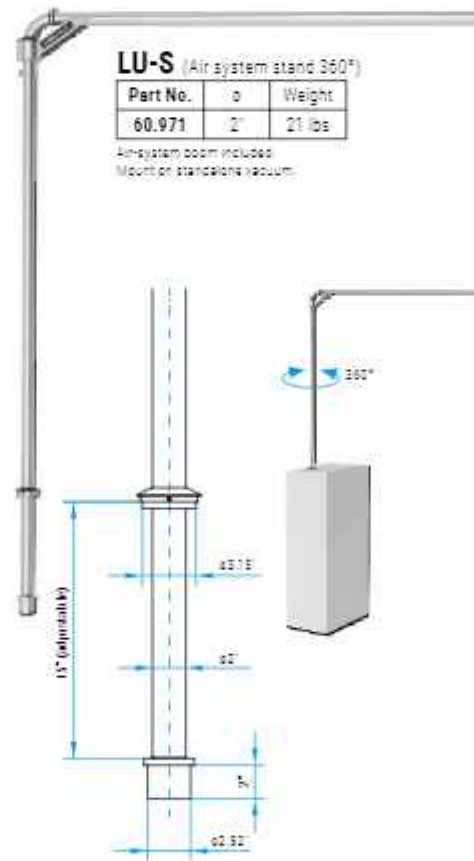
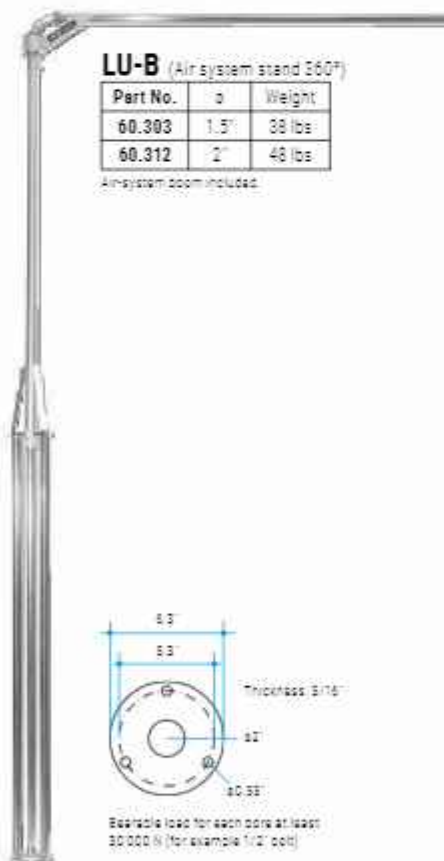

WWW.MOSMATIC.COM



## MOSMATIC DRYER

- ✓ In bay or island self serve drying
- ✓ Quick and streak-free drying
- ✓ Additional source of income
- ✓ Soft start option



Mosmatic Dry is the new, profit-generating attraction in self-service car wash systems. It dries vehicles, motorcycles and boats efficiently and leaves any type of vehicle streak free in the summer and winter. Gentle on your vehicles finish.



### MOSMATIC DRY

Dryer unit suitable for all Mosmatic Air-booms. A new attraction in your wash bay.

| Part No. | Width | Height | Depth | Weight |
|----------|-------|--------|-------|--------|
| 60.496   | 16.5" | 16.5"  | 10.7" | 68 lbs |

Universal dryer used for cars, motorcycles and boats. For wall installations. Also installs directly to your car wash bay using universal mounting plate. Mosmatic Dry needs to be installed under a roof.

Ready for installation:

- dryer with 230 VAC (illuminated)
- 2 x 7 ampere motors
- air-gun
- gun-holder (wall mount)
- hose (15')
- hose (2'5"), hose coupling to boom
- instruction sign with QR code to video
- owner's manual



### DRYER PACKAGES

| Part No. | Includes   |
|----------|--|
| 60.481   | Ceiling Boom (5'1"), 90° Pipe, Pulley, Mosmatic Dry, Gun/holder, Hoses |
| 60.483   | Wall Boom (5'3"), 90° Pipe, Pulley, Mosmatic Dry, Gun/holder, Hoses    |



#### Legend

M. = metric thrust, .M = male, F = female, B = gas pipe thrust, R = gas pipe thrust control, QV = quick connects, SV = profile ring fitting, D = diameter, L = length, NW = nominal width, SW = wrench size, IN = male input, OUT = male output, RG = basic position

|  |                            |                           |   |
|--|----------------------------|---------------------------|---|
| <b>Air-System Wall Boom Extension &amp; Air-System Boom</b><br>ø2", for wall mounting, top connection, 9'11"/85"     | <b>Part No.</b><br>60.955  | <b>Weight</b><br>82.5 lbs |        |
| <b>Bracket</b><br>with bumpers, for LU   | <b>Part No.</b><br>60.319  | <b>Weight</b><br>6.4 lbs  |        |
| <b>Extension (3'3")</b><br>ø1.5", 1x Pipe clamp included   | <b>Part No.</b><br>60.304  | <b>Weight</b><br>3.5 lbs  |  |
| ø2", 1x Pipe clamp included  | <b>Part No.</b><br>60.315  | <b>Weight</b><br>4.1 lbs  |   |
| <b>Extension (2'4")</b><br>ø2", 1x Pipe clamp included   | <b>Part No.</b><br>60.321  | <b>Weight</b><br>3.5 lbs  |  |
| <b>Instruction sign for Mosmatic Dry</b><br>3.9"/(3.9"/0.1") aluminum composite panel, silver, brushed, weatherproof | <b>Part No.</b><br>905.771 | <b>Weight</b><br>0.09 lbs |        |
| <b>Mosmatic Mat holder</b><br>for wall mounting, INOX  | <b>Part No.</b><br>90.050  | <b>Weight</b><br>1.0 lbs  |        |
| <b>Mounting Bracket</b><br>for DKZ, stainless steel<br>47 9/16"/2" (L/W/H)   | <b>Part No.</b><br>65.903  | <b>Weight</b><br>29.0 lbs |        |
| for DKZ, stainless steel<br>75 9/16"/2" (L/W/H)  | <b>Part No.</b><br>65.988  | <b>Weight</b><br>46.3 lbs |   |
| <b>Pipe clamp with bar and rubber</b><br>ø1.5" for air system  | <b>Part No.</b><br>902.480 | <b>Weight</b><br>0.11 lbs |      |
| ø2" for air system   | <b>Part No.</b><br>902.432 | <b>Weight</b><br>0.13 lbs |   |
| <b>Plug</b><br>for ø2" pipe, inside ø1.34"   | <b>Part No.</b><br>905.762 | <b>Weight</b><br>0.05 lbs |      |
| <b>Pulley</b><br>4'11" wire rope, pulling force up to 30N  | <b>Part No.</b>            | <b>Weight</b>             |      |
| ø1.5", 2x Pipe clamp included  | <b>Part No.</b><br>60.307  | <b>Weight</b><br>1.8 lbs  |   |
| ø2", 2x Pipe clamp included  | <b>Part No.</b><br>60.320  | <b>Weight</b><br>1.8 lbs  |   |
| <b>Swivel coupling</b><br>ø1.5", INOX, 1x Pipe clamp included  | <b>Part No.</b><br>60.308  | <b>Weight</b><br>0.9 lbs  |      |
| ø2", INOX, 1x Pipe clamp included  | <b>Part No.</b><br>60.323  | <b>Weight</b><br>1.1 lbs  |   |
| <b>45° Pipe</b><br>ø2", 1x Pipe clamp included   | <b>Part No.</b><br>60.328  | <b>Weight</b><br>1.1 lbs  |      |
| <b>90° Pipe</b><br>ø1.5", 1x Pipe clamp included   | <b>Part No.</b><br>60.305  | <b>Weight</b><br>0.9 lbs  |      |
| ø2", 1x Pipe clamp included  | <b>Part No.</b><br>60.314  | <b>Weight</b><br>0.9 lbs  |   |

# VERTICAL BOOM

- ✓ 360° smooth rotation
- ✓ Complete stainless steel (INOX)
- ✓ Solid construction
- ✓ Flexible tension arm

The convenient solution for a single wash station! The 360° range of rotation and built-in tension spring take up a minimal amount of space with full range of motion. All stainless steel vertical boom, mounting brackets included.



### SAW (vertical boom)

| Part No. | Length | Weight   |
|----------|--------|----------|
| 60.701   | 67"    | 10.0 lbs |
| 60.975   | 67"    | 10.4 lbs |

Accessories: hose, gun, wand, wand holder (not included)

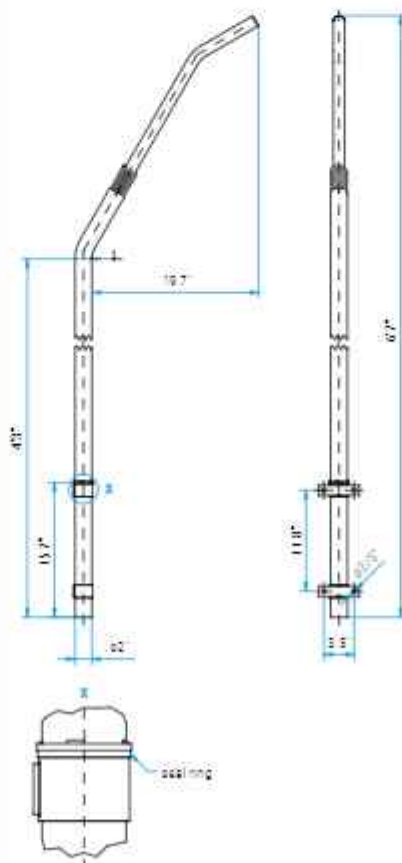
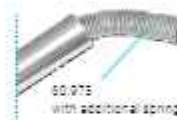

#### Legend

M... = metric thread, ...M = male, F = female, B = gas pipe thread, R = gas pipe thread conical, QV = quick connect, SV = profile ring fitting  
 D = diameter, L = length, NW = nominal width, SW = wrench size, IN = male input, OUT = male output, RG = basic position



- ✓ Everything for one-stop shopping
- ✓ Air-System boom option
- ✓ Complete package for self-service car wash

Equip your self-service car wash with the Mosmatic bay-package. Packages contain all the components to complete your self serve bays to have that finished clean appearance and functionality.



### 2 Packages, 4 Possibilities

#### Easy combine:

- Dual Set-up
- Triple Set-up
- Dual Set-up with MOSMATIC DRY
- Triple Set-up with MOSMATIC DRY

Products suited for Water Recycling

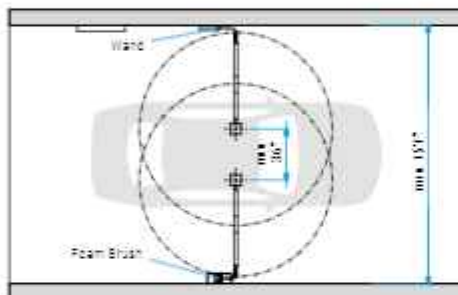

### Dual Set-up

| Part No. | 65.937   |  |
|----------|----------|--|
| Contains |          |  |
| Part No. | Quantity | Description  |
| 65.019   | 2x       | DKZ-Boom, 5'1", polished   |
| 26.980   | 1x       | Wand straight, 20'18", with nozzle guard   |
| 2507     | 1x       | High pressure nozzle 2507  |
| 32.564   | 1x       | DGV gun swivel, 3/8" NPTF - 3/8" NPTM  |
| 29.097   | 1x       | Wand-Holder spring model, with recovery port, floor mounted, stainless steel       |
| 29.082   | 1x       | HP-Gun with weep-system, 4500psi, 300°F  |
| 25.922   | 1x       | Brush Wand straight, 41'32", swivelling  |
| 29.027   | 1x       | Brush-Bucket wall- and floor mounted, 2" drain plug with overflow, stainless steel |
| 90.050   | 2x       | Mat-holders, stainless steel   |
| 90.090   | 2x       | HP-hose comfort, NW 1/4", 2900 psi, 140°F, length: 15'5"                           |

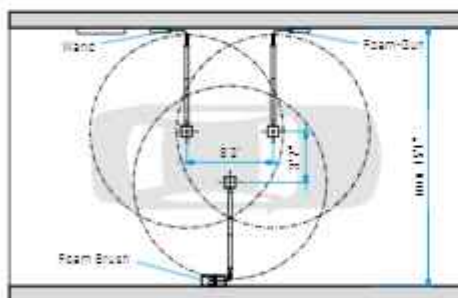

### Triple Set-up

| Part No. | 65.938   |  |
|----------|----------|--|
| Contains |          |  |
| Part No. | Quantity | Description  |
| 65.019   | 3x       | DKZ-Boom, 5'1", polished   |
| 26.980   | 1x       | Wand straight, 20'18", with nozzle guard   |
| 2507     | 1x       | High pressure nozzle 2507  |
| 32.564   | 1x       | DGV gun swivel, 3/8" NPTF - 3/8" NPTM  |
| 29.097   | 1x       | Wand-Holder spring model, with recovery port, floor mounted, stainless steel       |
| 29.082   | 1x       | HP-Gun with weep-system, 4500psi, 300°F  |
| 25.922   | 1x       | Brush Wand straight, 41'32", swivelling  |
| 29.027   | 1x       | Brush-Bucket wall- and floor mounted, 2" drain plug with overflow, stainless steel |
| 29.085   | 1x       | Foam Gun   |
| 5040     | 1x       | High pressure nozzle 5040  |
| 29.084   | 1x       | Foam gun holder, wall mount  |
| 90.050   | 2x       | Mat-holders, stainless steel   |
| 90.090   | 2x       | HP-hose comfort, NW 1/4", 2900 psi, 140°F, length: 15'5"                           |

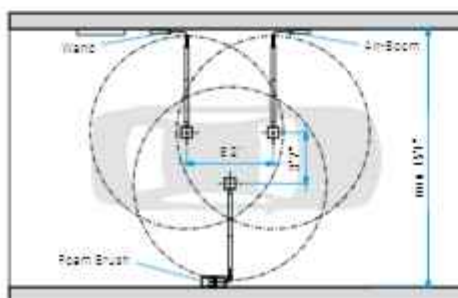

### MOSMATIC DRY Add-on to Dual Set-up

| Part No. | 60.929   |  |
|----------|----------|--|
| Contains |          |  |
| Part No. | Quantity | Description                              |
| 60.326   | 1x       | Air-Boom 2', 5'3", Ceiling-mounted       |
| 60.314   | 1x       | 90° elbow, 2", including clamp, INOX     |
| 60.320   | 1x       | Pulley, including clamp                  |
| 60.397   | 1x       | MOSMATIC DRY „Dryer“, wall-model, 110VAC |

For a more compact installation use extension shaft 902.753.

#### Legend

M... = metric thrust, ...M = male, F = female, Ø = gas pipe thrust, R = gas pipe thrust conical, QV = quick connects, SV = profile ring fitting  
 D = diameter, L = length, NW = nominal width, SW = wrench size, IN = male input, OUT = male output, RB = basic position

- ✓ High-quality workmanship
- ✓ Polished stainless steel
- ✓ Solid construction

Only Mosmatic offers you such an extensive variety of wand holders. Solid construction and high quality materials enhance their function and appearance that increases the value of your wash bay.



### Wand holder

spring model, floor mounted, with weep connection

| Part No. | L1    | D1   | Weight  |
|----------|-------|------|---------|
| 29.097   | 27.3" | 2.4" | 6.8 lbs |
| 29.121   | 33.7" | 2.4" | 8.4 lbs |



### Wand holder

with weep connection, floor mounted

| Part No.            | L1    | D1   | Weight  |
|---------------------|-------|------|---------|
| 29.028 <sup>m</sup> | 29.1" | 2.4" | 6.0 lbs |
| 29.113              | 29.1" | 2.4" | 5.1 lbs |

29.975 Stop feature replacement set



### Wand holder

with weep connection, floor mounted

| Part No. | L1    | D1   | Weight  |
|----------|-------|------|---------|
| 29.127   | 28.3" | 3.9" | 7.9 lbs |



### Wand holder

with weep connection, floor mounted

| Part No. | L1  | D1   | Weight  |
|----------|-----|------|---------|
| 29.115   | 29" | 2.4" | 4.4 lbs |

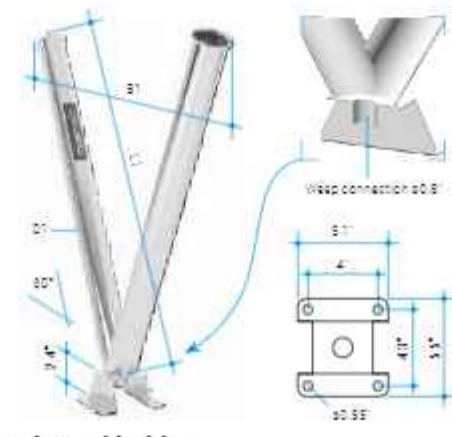

### Dual wand holder

with weep connection, floor mounted

| Part No. | L1  | B1    | D1   | Weight  |
|----------|-----|-------|------|---------|
| 29.124   | 29" | 31.5" | 2.4" | 8.8 lbs |



### Wand holder

wall mounted

| Part No. | L1    | D1   | Weight  |
|----------|-------|------|---------|
| 29.083   | 23.2" | 2.4" | 8.7 lbs |
| 29.128   | 8"    | 2.4" | 2.0 lbs |
| 29.143   | 28.3" | 3.9" | 7.9 lbs |

#### Legend

M. = metric thrust, .M = male, F = female, B = gas pipe thrust, R = gas pipe thrust control, DV = quick connect, SV = profile ring fitting  
 D = diameter, L = length, NW = nominal width, SW = wrench size, IN = male input, OUT = male output, RB = basic position

# BRUSH BUCKET



- ✓ Polished stainless steel
- ✓ Rugged design
- ✓ Solid construction
- ✓ High-quality workmanship
- ✓ Delivered ready to install

Mosmatic Brush buckets are made of stainless steel and come complete with wash out debris collectors. The high quality workmanship and state of the art design, upgrade your wash bay both visually and functionally.



### Brush bucket

wall- and floor mounted, polished stainless steel, 2" drain

| Part No. | W     | H     | D    | Weight |
|----------|-------|-------|------|--------|
| 29.026   | 13.4" | 26.8" | 5.6" | 18 lbs |



### Brush bucket

wall- and floor mounted with overflow, polished stainless steel, 2" drain

| Part No. | W     | H     | D    | Weight   |
|----------|-------|-------|------|----------|
| 29.027   | 13.4" | 26.8" | 5.6" | 18.5 lbs |



### Brush bucket

wall- and floor mounted with overflow, polished stainless steel, 2" drain, with a connection at the back

| Part No. | W     | H     | D    | Weight   |
|----------|-------|-------|------|----------|
| 29.114   | 13.4" | 26.8" | 6.4" | 18.5 lbs |



### Brush holder

for all sorts of brushes, wall mounted

| Part No. | W    | H    | D    | Weight  |
|----------|------|------|------|---------|
| 29.030   | 9.8" | 3.5" | 3.9" | 1.1 lbs |

WWW.MOSMATIC.COM

Legend

M. = metric thread, L = male, F = female, Ø = gas pipe thread, R = gas pipe thread conical, QV = quick connects, SV = profile ring fitting, D = diameter, L = length, NW = nominal width, SW = wrench size, IN = male inlet, OUT = male outlet, RB = basic position



- ✓ High-quality workmanship
- ✓ Polyurethane grip
- ✓ Delivered ready for installation

Mosmatic wands made of high quality stainless steel are the standard for your wash bay. The solid construction and the unique workmanship ensure longevity and value. Each wand has a modular design which allows for individual customer requirements. You choose the in-put-out-out, length, grip and matching accessories to suit your needs.



| TECHNICAL DATA    |                     |
|-------------------|---------------------|
| Pressure          | 4000 psi (27.5 MPa) |
| Temperature       | 250°F               |
| Nominal width     | 1/4"                |
| Throughput medium | pH 3-12             |

### Mosmatic LAN-C (Classic)

| Part No. | L   | GL  | G1       | WS  | DG  | IN        | OUT                 | Weight  |
|----------|-----|-----|----------|-----|-----|-----------|---------------------|---------|
| 26.980   | 30" | 3'  | straight | --- | --- | 1/4" NPTM | G3/8" M + 1/8" NPTF | 1.1 lbs |
| 26.981   | 30" | 3'  | bent     | --- | --- | 1/4" NPTM | G3/8" M + 1/8" NPTF | 1.1 lbs |
| 26.982   | 41" | 32" | straight | --- | --- | 1/4" NPTM | G3/8" M + 1/8" NPTF | 1.4 lbs |
| 26.983   | 41" | 32" | bent     | --- | --- | 1/4" NPTM | G3/8" M + 1/8" NPTF | 1.4 lbs |

|        |       |     |      |     |     |           |           |         |
|--------|-------|-----|------|-----|-----|-----------|-----------|---------|
| 25.905 | 37.5" | 32" | bent | --- | --- | 1/4" NPTM | 1/2" NPTM | 1.5 lbs |
| 25.906 | 37.5" | 32" | bent | --- | --- | 1/4" NPTF | 1/2" NPTM | 1.5 lbs |
| 25.907 | 37.5" | 32" | bent | --- | --- | 3/8" NPTM | 1/2" NPTM | 1.5 lbs |
| 25.908 | 37.5" | 32" | bent | --- | --- | 3/8" NPTF | 1/2" NPTM | 1.5 lbs |
| 25.909 | 37.5" | 32" | bent | --- | --- | 1/2" NPTM | 1/2" NPTM | 1.8 lbs |
| 25.910 | 37.5" | 32" | bent | --- | --- | 1/2" NPTF | 1/2" NPTM | 1.8 lbs |

L = total length, GL = grip length, Nozzles not included.

### Mosmatic LAN-P (Pro)

| Part No. | L   | GL  | G1       | WS  | DG  | IN      | OUT       | Weight  |
|----------|-----|-----|----------|-----|-----|---------|-----------|---------|
| 28.520   | 24" | 12" | straight | --- | --- | G3/8" F | 1/4" NPTF | 2.2 lbs |
| 28.521   | 24" | 12" | bent     | --- | --- | G3/8" F | 1/4" NPTF | 2.2 lbs |
| 28.522   | 24" | 12" | straight | yes | --- | G3/8" F | 1/4" NPTF | 2.2 lbs |
| 28.523   | 24" | 12" | bent     | yes | --- | G3/8" F | 1/4" NPTF | 2.2 lbs |
| 28.524   | 24" | 12" | straight | yes | yes | G3/8" F | 1/4" NPTF | 2.5 lbs |
| 28.525   | 24" | 12" | bent     | yes | yes | G3/8" F | 1/4" NPTF | 2.5 lbs |
| 28.530   | 39" | 28" | straight | --- | --- | G3/8" F | 1/4" NPTF | 3.1 lbs |
| 28.531   | 39" | 28" | bent     | --- | --- | G3/8" F | 1/4" NPTF | 3.1 lbs |
| 28.532   | 39" | 28" | straight | yes | --- | G3/8" F | 1/4" NPTF | 3.1 lbs |
| 28.533   | 39" | 28" | bent     | yes | --- | G3/8" F | 1/4" NPTF | 3.1 lbs |
| 28.534   | 39" | 28" | straight | yes | yes | G3/8" F | 1/4" NPTF | 3.4 lbs |
| 28.535   | 39" | 28" | bent     | yes | yes | G3/8" F | 1/4" NPTF | 3.4 lbs |

L = total length (without PP-DV), GL = grip length, Nozzles not included.

### Mosmatic LAN-P (Pro)

| Part No. | L   | GL  | G1       | WS  | DG  | IN        | OUT       | Weight  |
|----------|-----|-----|----------|-----|-----|-----------|-----------|---------|
| 904.098  | 13" | 12" | straight | --- | --- | 1/4" NPTM | 1/4" NPTM | 0.7 lbs |
| 902.917  | 24" | 12" | straight | --- | --- | 1/4" NPTM | 1/4" NPTM | 0.9 lbs |
| 902.964  | 24" | 12" | bent     | --- | --- | 1/4" NPTM | 1/4" NPTM | 0.9 lbs |
| 903.655  | 28" | 12" | straight | --- | --- | 1/4" NPTM | 1/4" NPTM | 0.9 lbs |
| 902.982  | 28" | 12" | bent     | --- | --- | 1/4" NPTM | 1/4" NPTM | 0.9 lbs |
| 903.118  | 35" | 28" | straight | --- | --- | 1/4" NPTM | 1/4" NPTM | 1.8 lbs |
| 904.848  | 35" | 28" | bent     | --- | --- | 1/4" NPTM | 1/4" NPTM | 1.8 lbs |
| 902.918  | 39" | 12" | straight | --- | --- | 1/4" NPTM | 1/4" NPTM | 1.3 lbs |
| 902.981  | 39" | 12" | bent     | --- | --- | 1/4" NPTM | 1/4" NPTM | 1.3 lbs |
| 905.808  | 47" | 16" | straight | --- | --- | 1/4" NPTM | 1/4" NPTM | 1.8 lbs |
| 905.803  | 47" | 16" | bent     | --- | --- | 1/4" NPTM | 1/4" NPTM | 1.8 lbs |

L = total length, GL = grip length, Nozzles not included.

#### Legend

M. = metric thrust, .M = male, F = female, B = gas pipe thrust, R = gas pipe thrust control, DV = quick connect, SW = profile ring fitting, D = diameter, L = length, NW = nominal width, SW = wrench size, IN = male input, OUT = male output, RG = basic position

# INDIVIDUAL WANDS

- ✓ Customize to your needs
- ✓ Quality craftsmanship



Design your personal high pressure wand. Simply choose the input-output, length, grip and matching accessories to suit your needs. Follow the steps 1, 2 and 3 to get the correct part number.

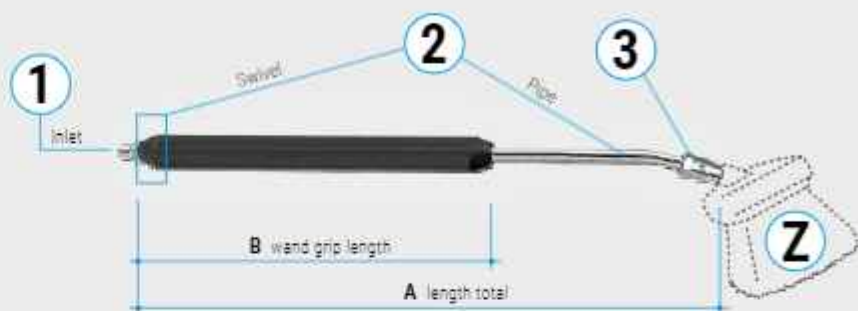

| 1 | Inlet | No. |
|---|-------|-----|
|   |       | 21. |
|   |       | 22. |
|   |       | 25. |
|   |       | 26. |

| 2                                    | Pipe straight |     | Pipe bent      |             |
|--------------------------------------|---------------|-----|----------------|-------------|
|                                      |               |     | without Swivel | with Swivel |
|                                      | A             | B   | No.            | No.         |
| Other versions of sizes upon request | 10'           | 8'  | 01             | 41          |
|                                      | 14'           | 8'  | 02             | 42          |
|                                      | 20'           | 8'  | 03             | 43          |
|                                      | 26'           | 16' | 04             | 44          |
|                                      | 30'           | 16' | 05             | 45          |
|                                      | 34'           | 16' | 06             | 46          |
|                                      | 34'           | 32' | 07             | 47          |
|                                      | 38'           | 16' | 08             | 48          |
|                                      | 38'           | 32' | 09             | 49          |
|                                      | 41'           | 16' | 10             | 50          |
|                                      | 41'           | 32' | 11             | 51          |
|                                      | 50'           | 40' | 12             | 52          |
|                                      | 60'           | 51' | 13             | 53          |
|                                      | 70'           | 51' | 14             | 54          |
|                                      | 80'           | 72' | 15             | 55          |

Your Part No.



| 3 | Outlet                                    | No. |
|---|---|-----|
|   | Nozzle socket 1/8" NPTF for locking-screw | 0   |
|   | Nozzle socket 1/8" NPTF for snap-lock     | 1   |
|   | Nozzle socket 1/4" NPTF for locking-screw | 2   |
|   | Nozzle socket 1/4" NPTF for snap-lock     | 3   |
|   | R1/4" M (R+conical)                       | 4   |
|   | Foam injector ø0.1" R1/4" M (R+conical)   | 5   |
|   | Nozzle socket G3/8" M 1/8" NPTF           | 6   |
|   | Nozzle socket ø0.63" 1/4" NPTF            | 7   |
|   | HP-Coupling ø0.47"                        | 8   |

| Z      | Suitable Accessories |
|--------|----------------------|
| 29.001 |                      |
| 29.002 |                      |
| 29.003 |                      |
| 29.006 |                      |
| 29.007 |                      |
| 29.008 |                      |
| 29.010 |                      |
| 29.011 |                      |
| 29.012 |                      |
| 29.013 |                      |
| 29.014 |                      |
| 29.015 |                      |
| 29.016 |                      |
| 29.017 |                      |
| 29.018 |                      |
| 29.019 |                      |
| 29.020 |                      |
| 29.021 |                      |
| 29.022 |                      |
| 29.023 |                      |
| 29.024 |                      |
| 29.025 |                      |
| 29.026 |                      |
| 29.027 |                      |
| 29.028 |                      |
| 29.029 |                      |
| 29.030 |                      |
| 29.031 |                      |
| 29.032 |                      |
| 29.033 |                      |
| 29.034 |                      |
| 29.035 |                      |
| 29.036 |                      |
| 29.037 |                      |
| 29.038 |                      |
| 29.039 |                      |
| 29.040 |                      |
| 29.041 |                      |
| 29.042 |                      |
| 29.043 |                      |
| 29.044 |                      |
| 29.045 |                      |
| 29.046 |                      |
| 29.047 |                      |
| 29.048 |                      |
| 29.049 |                      |
| 29.050 |                      |
| 29.051 |                      |
| 29.052 |                      |
| 29.053 |                      |
| 29.054 |                      |
| 29.055 |                      |
| 29.056 |                      |
| 29.057 |                      |
| 29.058 |                      |
| 29.059 |                      |
| 29.060 |                      |
| 29.061 |                      |
| 29.062 |                      |
| 29.063 |                      |
| 29.064 |                      |
| 29.065 |                      |
| 29.066 |                      |
| 29.067 |                      |
| 29.068 |                      |
| 29.069 |                      |
| 29.070 |                      |
| 29.071 |                      |
| 29.072 |                      |
| 29.073 |                      |
| 29.074 |                      |
| 29.075 |                      |
| 29.076 |                      |
| 29.077 |                      |
| 29.078 |                      |
| 29.079 |                      |
| 29.080 |                      |
| 29.081 |                      |
| 29.082 |                      |
| 29.083 |                      |
| 29.084 |                      |
| 29.085 |                      |
| 29.086 |                      |
| 29.087 |                      |
| 29.088 |                      |
| 29.089 |                      |
| 29.090 |                      |
| 29.091 |                      |
| 29.092 |                      |
| 29.093 |                      |
| 29.094 |                      |
| 29.095 |                      |
| 29.096 |                      |
| 29.097 |                      |
| 29.098 |                      |
| 29.099 |                      |
| 29.100 |                      |

Nozzles not included

WWW.MOSMATIC.COM



## WAND WITH FILTER SIEVE

- ✓ High-quality craftsmanship
- ✓ Polyurethane grip
- ✓ Optimal for recycled water

The high quality stainless steel Mosmatic wand with integrated filter. Ideal for an application not using a high pressure gun, connecting the hose directly to the wand.

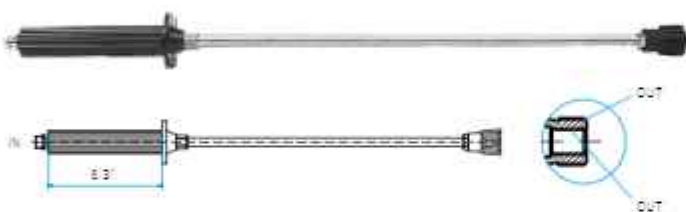

### Mosmatic LAS-C (Classic-Wand with filter sieve, hard plastic handle)

| Part No. | L   | IN        | OUT                 | Weight  |
|----------|-----|-----------|---------------------|---------|
| 28.201   | 10" | 1/4" NPTM | G3/8" M + 1/8" NPTF | 1.0 lbs |
| 28.202   | 14" | 1/4" NPTM | G3/8" M + 1/8" NPTF | 1.0 lbs |
| 28.203   | 20" | 1/4" NPTM | G3/8" M + 1/8" NPTF | 1.1 lbs |
| 28.204   | 26" | 1/4" NPTM | G3/8" M + 1/8" NPTF | 1.1 lbs |
| 28.205   | 30" | 1/4" NPTM | G3/8" M + 1/8" NPTF | 1.3 lbs |
| 28.206   | 34" | 1/4" NPTM | G3/8" M + 1/8" NPTF | 1.3 lbs |
| 28.251   | 10" | 3/8" NPTM | G3/8" M + 1/8" NPTF | 1.0 lbs |
| 28.252   | 14" | 3/8" NPTM | G3/8" M + 1/8" NPTF | 1.0 lbs |
| 28.253   | 20" | 3/8" NPTM | G3/8" M + 1/8" NPTF | 1.1 lbs |
| 28.254   | 26" | 3/8" NPTM | G3/8" M + 1/8" NPTF | 1.3 lbs |
| 28.255   | 30" | 3/8" NPTM | G3/8" M + 1/8" NPTF | 1.3 lbs |
| 28.256   | 34" | 3/8" NPTM | G3/8" M + 1/8" NPTF | 1.3 lbs |
| 28.301   | 10" | 1/4" NPTM | 1/4" NPTF           | 1.0 lbs |
| 28.302   | 14" | 1/4" NPTM | 1/4" NPTF           | 1.0 lbs |
| 28.303   | 20" | 1/4" NPTM | 1/4" NPTF           | 1.1 lbs |
| 28.304   | 26" | 1/4" NPTM | 1/4" NPTF           | 1.1 lbs |
| 28.305   | 30" | 1/4" NPTM | 1/4" NPTF           | 1.3 lbs |
| 28.306   | 34" | 1/4" NPTM | 1/4" NPTF           | 1.3 lbs |
| 28.351   | 10" | 3/8" NPTM | 1/4" NPTF           | 1.0 lbs |
| 28.352   | 14" | 3/8" NPTM | 1/4" NPTF           | 1.0 lbs |
| 28.353   | 20" | 3/8" NPTM | 1/4" NPTF           | 1.1 lbs |
| 28.354   | 26" | 3/8" NPTM | 1/4" NPTF           | 1.3 lbs |
| 28.355   | 30" | 3/8" NPTM | 1/4" NPTF           | 1.3 lbs |
| 28.356   | 34" | 3/8" NPTM | 1/4" NPTF           | 1.3 lbs |

L = total length, nozzles not included



### Mosmatic LAH-C (Classic-Wand with filter, Polyurethane - molded soft handle)

| Part No. | L   | IN      | OUT                 | Weight  |
|----------|-----|---------|---------------------|---------|
| 28.404   | 26" | G3/8" F | G3/8" M + 1/8" NPTF | 1.1 lbs |
| 28.414   | 26" | G3/8" F | G3/8" M + 1/4" NPTF | 1.1 lbs |
| 28.405   | 30" | G3/8" F | G3/8" M + 1/8" NPTF | 1.1 lbs |
| 28.415   | 30" | G3/8" F | G3/8" M + 1/4" NPTF | 1.1 lbs |

L = total length  
100 pieces or more available with red or blue handles. Nozzles not included.

#### TECHNICAL DATA

|                   |                     |
|-------------------|---------------------|
| Pressure          | 4000 psi (27.5 MPa) |
| Temperature       | 250°F               |
| Nominal width     | 1/4"                |
| Throughput medium | pH 3-12             |

#### Legend

M. = metric thrust, .M = male, F = female, B = gas pipe thrust, R = gas pipe thrust control, QV = quick connect, SW = profile ring fitting, D = diameter, L = length, NW = nominal width, SW = wrench size, IN = male input, OUT = male output, RG = basic position



- ✓ Perfect for self-service car wash
- ✓ Ergonomic design and easy handling
- ✓ Intensive cleaning also in the food industry

Mosmatic Foam Accessories are a great opportunity to complement your existing wash program with another lucrative option. You can choose between different options or combine the components yourself. The cleaning power of foam is also ideal for the food industry. Foam covering allows for better cleaning results, with more concentrated chemical saturation.



### Foam Wand (black)

| Part No. | L   | WA  | IN      | Nozzle size | Weight  |
|----------|-----|-----|---------|-------------|---------|
| 29.123   | 28" | 20" | G3/8" F | 1.6         | 2.4 lbs |

L = total length, WA = lance length

The foam wand is an ideal complement for special cleaning and facility management. The foam nozzle with air injector produces an optimal foam consistency. This guarantees an easy and quick removal of dirt.



### Coax Wand

| Part No. | L   | IN        | OUT          | Weight  |
|----------|-----|-----------|--------------|---------|
| 24.970   | 30" | 1/4" NPTM | 2x 1/8" NPTF | 2.0 lbs |

L = total length, please order HP-nozzle, HP-Gun and Foam-head separately

The Coax Wand is a 2 in 1 product. It allows to switch between High Pressure and Foam simply through a quarter turn on the attached handle. To be able to use the foam-option, an additional chemical regulator (Part No. 90.087 or 90.097) needs to be installed on the High Pressure pump to create foam.

The Vario Wand can be adjusted on the regulator. So you always wash with the desired amount of water.



### Vario Wand

| Part No. | L   | IN        | OUT       | Weight  |
|----------|-----|-----------|-----------|---------|
| 24.978   | 39" | 1/4" NPTM | 1/4" NPTM | 2.0 lbs |

L = total length

### Chemical Regulator

with metering valve

| Part No. | L    | IN/OUT | Fitting         | Size | Weight  |
|----------|------|--------|-----------------|------|---------|
| 90.087   | 6.7" | M22    | brass           | 1.6  | 2.0 lbs |
| 90.097   | 6.7" | M22    | stainless steel | 1.6  | 2.0 lbs |

The completely stainless steel regulator easily installs between your pressure washer and your high pressure hose. Adjust the chemical dial to determine between thick and thin layers of foam coverage.



### Foam Head

Nozzle attachment for normal HP-wands

| Part No. | Material        | Color | L  | IN      | Size | Weight  |
|----------|-----------------|-------|----|---------|------|---------|
| 29.122   | brass           | black | 5" | G1/4" F | 1.6  | 0.3 lbs |
| 29.129   | stainless steel | blue  | 7" | G1/4" F | 1.9  | 0.4 lbs |
| 29.139   | brass           | black | 7" | G1/4" F | 1.6  | 0.4 lbs |
| 29.156   | brass           | black | 7" | G1/4" F | 1.9  | 0.4 lbs |

Mount the Mosmatic foam head to any existing spray wand. Adjustable flat spray nozzle allows quick adjustment for different foam applications.

#### TECHNICAL DATA

|                   |                   |
|-------------------|-------------------|
| Pressure          | 4500 psi (31 MPa) |
| Temperature       | 212°F             |
| Throughput        | max. 12 gpm       |
| Throughput medium | pH 3-12           |



#### Legend

M... = metric thrust, L...M = male, F = female, Ø = gas pipe thrust, R = gas pipe thrust conical, QV = quick connects, SW = profile ring fitting, D = diameter, L = length, NW = nominal width, SW = wrench size, IN = male input, OUT = male output, RB = basic position

- ✓ Natural hogs hair (2.4")
- ✓ Rugged design
- ✓ Solid construction
- ✓ Polyurethane grip
- ✓ Delivered ready to install

Make Mosmatic foam brush the standard in your wash bay. The solid construction and the unique workmanship ensure longevity and value. Each foam brush has a modular design which allows for individual customer requirements. You choose the in-input/out-put, the length of the wand and the protective tube as the matching accessories.



### Mosmatic B-LAN-C (Classic)

| Part No. | L   | GL  | DG  | IN        | Weight  |
|----------|-----|-----|-----|-----------|---------|
| 25.902   | 41" | 32" | --- | 3/8" NPTF | 2.9 lbs |
| 25.922   | 41" | 32" | yes | 3/8" NPTF | 3.4 lbs |
| 25.903   | 50" | 40" | --- | 3/8" NPTF | 3.4 lbs |
| 25.923   | 50" | 40" | yes | 3/8" NPTF | 3.7 lbs |

L = total length, GL = grip length



### Mosmatic B-LAN-C (Classic foam brush for snap lock systems)

| Part No. | L   | GL  | DS  | IN        | Weight  |
|----------|-----|-----|-----|-----------|---------|
| 25.988   | 38" | 32" | yes | 3/8" NPTM | 1.9 lbs |

L = total length, GL = grip length, DS = nozzle guard incl. Nozzles not included

|        |  |           |
|--------|--|-----------|
| 29.003 | Nozzle guard                               | 0.008 lbs |
| 29.006 | Brush head complete with snap-lock feature | 2.5 lbs   |



### Mosmatic B-LAN-P (Pro)

| Part No. | L   | GL  | WS  | DG  | IN      | Weight  |
|----------|-----|-----|-----|-----|---------|---------|
| 28.540   | 24" | 12" | --- | --- | G3/8" F | 3.8 lbs |
| 28.541   | 24" | 12" | yes | --- | G3/8" F | 3.8 lbs |
| 28.542   | 24" | 12" | yes | yes | G3/8" F | 3.8 lbs |
| 28.545   | 40" | 28" | --- | --- | G3/8" F | 4.7 lbs |
| 28.546   | 40" | 28" | yes | --- | G3/8" F | 4.7 lbs |
| 28.547   | 40" | 28" | yes | yes | G3/8" F | 4.7 lbs |

L = total length (without HF-Gun), GL = grip length

#### TECHNICAL DATA

|                   |                     |
|-------------------|---------------------|
| Pressure          | 4000 psi (27.5 MPa) |
| Temperature       | 250°F               |
| Nominal width     | 1/4"                |
| Throughput medium | pH 3-12             |

#### Legend

M. = metric thrust, ...M = male, F = female, B = gas pipe thrust, R = gas pipe thrust control, DV = quick connect, SV = profile ring fitting, D = diameter, L = length, NW = nominal width, SW = wrench size, IN = male input, OUT = male output, RG = basic position

# INDIVIDUAL FOAM BRUSHES



- ✓ Complete wands with brush head
- ✓ Natural hogs hair (2.4")
- ✓ Delivered ready for installation

Customize Mosmatic brushes to your unique application. Simply choose your in-put out-put and desired components by following steps 1-3 to get your part number.

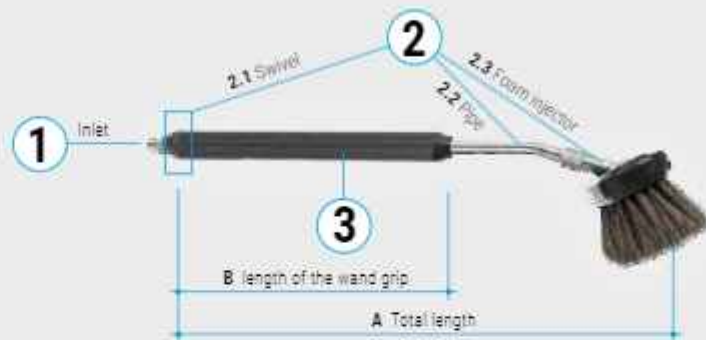

| 1 | Inlet                | No. |
|---|----------------------|-----|
|   | M21 x 1.5 F          | 21. |
|   | M22 x 1.5 F          | 22. |
|   | conical<br>3/8" NPTM | 25. |
|   | 1/4" NPTM            | 26. |

| 2.1       | 2.2      | 2.3           | No. |
|-----------|----------|---------------|-----|
| Swivel    | Pipe     | Foam injector |     |
| w/without | straight | w/without     | 90  |
| w/without | bent     | w/without     | 91  |
| w/without | straight | w/with        | 94  |
| w/without | bent     | w/with        | 95  |
| w/with    | straight | w/without     | 92  |
| w/with    | bent     | w/without     | 93  |
| w/with    | straight | w/with        | 96  |
| w/with    | bent     | w/with        | 97  |

Your Part No.

**2** **5** . **9** **7** **3** =



| 3                                    | A    | B   | No.               |
|--------------------------------------|------|-----|-------------------|
| Other versions or sizes upon request | 36"  | 24" | 1 (only bent)     |
|                                      | 36"  | 32" | 1 (only straight) |
|                                      | 41"  | 32" | 2                 |
|                                      | 50"  | 40" | 3                 |
|                                      | 60"  | 51" | 4                 |
|                                      | 70"  | 51" | 5                 |
|                                      | 80"  | 72" | 6                 |
|                                      | 100" | 72" | 7                 |

Legend

M. = metric thrust, M = male, F = female, B = gas side thrust, R = gas side thrust conical, QV = quick connects, SV = profile ring fitting, D = diameter, L = length, NW = nominal width, SW = wrench size, IN = male input, OUT = male output, RB = basic position



## FLEX-BRUSH WAND

- ✓ Minimum working pressure 40 psi
- ✓ Minimum flow ratio 1.32 gpm
- ✓ Natural hogs hair
- ✓ Suitable for weep system
- ✓ Available in multiple lengths
- ✓ Available with built-in swivel

The Mosmatic Flex-Brush Wand provides an additional function when compared to all standard brushes. Directly in front of the head is a mechanism, which slackens the brush head when not under pressure. Increase the pressure and the head solidifies. The Flex-Brush Wand only works under pressure. The pressure build-up occurs by adding coins in the coin box. Durable lightweight construction makes it easy to use while giving you added savings of a longer-lasting brush head. The triple foam wash cycle can not be used with the Flex-Brush Wand.

**NOT AVAILABLE IN USA**



Mark (inside):  
L = low pressure (40 - 150 psi)  
H = high pressure (150 - 1200 psi)

### F-LAN (40 - 150 psi, minimum 1.32 gpm)

| Part No. | L   | IN      | Foam injector | DG  | Handle | Weight  |
|----------|-----|---------|---------------|-----|--------|---------|
| 27.102   | 39" | R1/4" M | yes           | --- | ---    | 3.9 lbs |
| 27.103   | 51" | R1/4" M | yes           | --- | ---    | 4.4 lbs |
| 27.122   | 39" | G1/4" M | yes           | yes | ---    | 4.2 lbs |
| 27.123   | 51" | G1/4" M | yes           | yes | ---    | 4.6 lbs |
| 27.302   | 47" | G1/4" M | yes           | --- | yes    | 4.4 lbs |
| 27.303   | 59" | G1/4" M | yes           | --- | yes    | 5.0 lbs |
| 27.322   | 47" | G1/4" M | yes           | yes | yes    | 4.7 lbs |
| 27.323   | 59" | G1/4" M | yes           | yes | yes    | 5.3 lbs |

L = total length

### F-LAN HD (150 - 1200 psi, minimum 2.38 gpm)

| Part No. | L   | IN      | Foam injector | DG  | Handle | Weight  |
|----------|-----|---------|---------------|-----|--------|---------|
| 27.107   | 39" | R1/4" M | yes           | --- | ---    | 3.9 lbs |
| 27.108   | 51" | R1/4" M | yes           | --- | ---    | 4.4 lbs |
| 27.127   | 39" | G1/4" M | yes           | yes | ---    | 4.2 lbs |
| 27.128   | 51" | G1/4" M | yes           | yes | ---    | 4.6 lbs |
| 27.307   | 47" | G1/4" M | yes           | --- | yes    | 4.4 lbs |
| 27.308   | 59" | G1/4" M | yes           | --- | yes    | 5.0 lbs |
| 27.327   | 47" | G1/4" M | yes           | yes | yes    | 4.7 lbs |
| 27.328   | 59" | G1/4" M | yes           | yes | yes    | 5.3 lbs |

L = total length

### Instruction Board

This instruction board explains the concept of the Flex-Brush Wand. It clarifies that the Flex-Brush Wand only works with a paid program. Install the board close to Flex-Brush Wand for visual instruction.

| Part No. | Width | Height | Material    | Weight  |
|----------|-------|--------|-------------|---------|
| 902.999  | 12"   | 28"    | 0.68" Forex | 0.7 lbs |



#### TECHNICAL DATA

|                   |                              |
|-------------------|------------------------------|
| Pressure          | 40 - 1200 psi (0.25 - 8 MPa) |
| Temperature       | 250°F                        |
| Nominal width     | 1/4"                         |
| Throughput medium | pH 3-12                      |

#### Legend

M = metric thread, ...M = male, F = female, B = gas pipe thread, R = gas pipe thread conical, DV = quick connect, SV = profile ring fitting, D = diameter, L = length, NW = nominal width, SW = wrench size, IN = male input, OUT = male output, RG = basic position

| Brush   | Part No. | Weight  |  |
|---|----------|---------|--|
| 2.4' Hogs hair  | 29.011   | 0.6 lbs |  |
| 3.5' Hogs hair  | 29.065   | 0.7 lbs |  |
| Brush Body  | Part No. | Weight  |  |
| Stainless steel, incl. 2x M5x12 bolts, IN 1/4" F  | 29.012   | 0.5 lbs |  |
| Stainless steel, incl. 2x M5x12 bolts, IN 1/2" NPTF   | 29.138   | 0.7 lbs |  |
| Brush Guard   | Part No. | Weight  |  |
| neutral, plastic, black   | 29.013   | 0.2 lbs |  |
| Brush Head Complete   | Part No. | Weight  |  |
| 2.4' Hogs hair, with locking-bolt   | 29.001   | 1.6 lbs |  |
| 2.4' Hogs hair, with snap-lock feature  | 29.006   | 1.8 lbs |  |
| 2.4' Hogs hair, IN 1/4" F   | 29.007   | 1.3 lbs |  |
| 3.5' Hogs hair, IN 1/4" F   | 29.064   | 1.4 lbs |  |
| 2.4' Hogs hair, IN 1/2" NPTF  | 29.151   | 1.5 lbs |  |
| 3.5' Hogs hair, IN 1/2" NPTF  | 29.152   | 1.6 lbs |  |
|   |          |         |  |
| Brush Holder  | Part No. | Weight  |  |
| stainless, with locking-bolt  | 29.014   | 0.4 lbs |  |
| Brush Holder  | Part No. | Weight  |  |
| for all sorts of brushes, wall mounted  | 29.030   | 1.1 lbs |  |
| Check Valve (~14 psi)   | Part No. | Weight  |  |
| with hard spring, opening pressure ~14 psi, closing pressure ~20 psi<br>NW 1/4", 4000 psi 200°F |          |         |  |
| ø3/4", INOX, 2.1", IN 1/4" NPTF, OUT 1/4" NPTF  | 90.111   | 0.2 lbs |  |
| ø1", INOX, 2.2", IN 1/4" NPTF, OUT 3/8" NPTF  | 90.112   | 0.2 lbs |  |
| ø1", INOX, 2.2", IN 3/8" NPTF, OUT 1/4" NPTF  | 90.113   | 0.2 lbs |  |
| ø1", INOX, 2.3", IN 3/8" NPTF, OUT 3/8" NPTF  | 90.114   | 0.3 lbs |  |
| Check Valve (~1.5 psi)  | Part No. | Weight  |  |
| with soft spring, opening pressure ~1.5 psi, closing pressure ~2 psi<br>NW 1/4", 4000 psi 200°F |          |         |  |
| ø3/4", INOX, 2.1", IN 1/4" NPTF, OUT 1/4" NPTF  | 90.115   | 0.2 lbs |  |
| ø1", INOX, 2.2", IN 1/4" NPTF, OUT 3/8" NPTF  | 90.116   | 0.2 lbs |  |
| ø1", INOX, 2.2", IN 3/8" NPTF, OUT 1/4" NPTF  | 90.117   | 0.2 lbs |  |
| ø1", INOX, 2.3", IN 3/8" NPTF, OUT 3/8" NPTF  | 90.118   | 0.3 lbs |  |
| Double Mounting Plate   | Part No. | Weight  |  |
| for two wand holders ø2.4", for floor mounting 3.6"x3.6", 13.4"/9.6"/3.4"                       | 29.999   | 7.1 lbs |  |
| Foam Injector   | Part No. | Weight  |  |
| ø0.1", G1/4" F - R1/4" M<br>90 psi 2.4 gpm, 1450 psi 9 gpm                                      | 29.020   | 0.1 lbs |  |
| ø0.1", M12x1 F - R1/4" M<br>90 psi 2.4 gpm, 1450 psi 9 gpm                                      | 29.021   | 0.1 lbs |  |
| ø0.06", G1/4" F - R1/4" M<br>90 psi 0.8 gpm, 1450 psi 3.3 gpm                                   | 29.060   | 0.1 lbs |  |

| Hand Grip   | Part No. | Weight   |  |
|---|----------|----------|--|
| PP hand grip - ergonomically                          |          |          |  |
| IN 1/4" NPTM, OUT 1/4" NPTF                           | 29.070   | 0.7 lbs  |  |
| IN 3/8" NPTF, OUT 1/8" NPTF                           | 29.085   | 0.7 lbs  |  |
| IN 1/4" M, OUT 1/8" NPTF                              | 29.095   | 0.7 lbs  |  |
| Handle  | Part No. | Weight   |  |
| with filter sieve, hard plastic                       |          |          |  |
| IN 1/4" M, OUT M12 x 1 F                              | 29.801   | 0.7 lbs  |  |
| IN 3/8" M, OUT M12 x 1 F                              | 29.802   | 0.7 lbs  |  |
| IN 1/4" M, OUT 1/4" F                                 | 29.803   | 0.7 lbs  |  |
| Replacement filter sieve                              | 29.023   | 0.1 oz   |  |
| Adaptor for LAN-P                                     | Part No. | Weight   |  |
| SW0.78", ø1.5"  | 904.097  | 0.02 lbs |  |
| Handle Holder   | Part No. | Weight   |  |
| ø2.4", L=7.8"   | 29.128   | 2.0 lbs  |  |
| HP Hose Comfort                                       | Part No. | Weight   |  |
| NW 3/8", lightweight construction, inner core PES     |          |          |  |
| 12", IN 3/8" NPTM, OUT 3/8" NPTM                      | 90.089   | 1.1 lbs  |  |
| 14", IN 3/8" NPTM, OUT 3/8" NPTM                      | 90.088   | 1.3 lbs  |  |
| 16", IN 3/8" NPTM, OUT 3/8" NPTM                      | 90.090   | 1.3 lbs  |  |
| Mosmatic HP Gun «Nano»                                | Part No. | Weight   |  |
| 4000 psi, 300°F, weep<br>IN 3/8" NPTF, OUT 1/4" NPTF  | 29.082   | 1.8 lbs  |  |
| More products see HP Gun page.                        |          |          |  |
| Mosmatic Mat Holder                                   | Part No. | Weight   |  |
| for wall mounting, INOX                               | 90.050   | 1.0 lbs  |  |
| Nozzle Guard  | Part No. | Weight   |  |
| plug on ø0.6" & G3/8"                                 | 29.010   | 0.02 lbs |  |
| for 1/8" NPT, SW 1/2"                                 | 29.002   | 0.02 lbs |  |
| for 1/8" & 1/4" NPT                                   | 29.003   | 0.02 lbs |  |
| Nozzle Socket   | Part No. | Weight   |  |
| for locking-screw SW 3/4"<br>IN 1/4" F, OUT 1/8" NPTF | 29.016   | 0.1 lbs  |  |
| for locking-screw SW 3/4"<br>IN 1/4" F, OUT 1/4" NPTF | 29.017   | 0.1 lbs  |  |
| for snap-lock SW 3/4"<br>IN 1/4" F, OUT 1/8" NPTF     | 29.018   | 0.2 lbs  |  |
| for snap-lock SW 3/4"<br>IN 1/4" F, OUT 1/4" NPTF     | 29.019   | 0.2 lbs  |  |
| ø0.6", IN M12x1 F, OUT 1/8" NPTF + G3/8" M            | 29.042   | 0.06 lbs |  |
| Nozzles   | Part No. | Weight   |  |
| for foam brush 1/8" NPT                               | xx.xxx   | 0.02 lbs |  |
| for HP wand   | xx.xxx   | 0.02 lbs |  |
| More products see nozzle page.                        |          |          |  |
| OEM Wands   | Part No. | Weight   |  |
| LAN-P, 23.6"/11.8", IN: 3/8" NPTF                     | 28.722   | 2.4 lbs  |  |
| B-LAN-R, 37.4"/27.5", IN: 3/8" NPTF                   | 28.748   | 4.0 lbs  |  |

| Sign for F-LAN           | Part No.       | Weight  |   |
|--------------------------|----------------|---------|---|
| 11.8"/27,6"/0.08", Forex | <b>902.999</b> | 0.7 lbs |  |

| Snap-Lock Feature             | Part No.      | Weight  |   |
|-------------------------------|---------------|---------|---|
| stainless, aluminium, Ø1/4" M | <b>29.015</b> | 0.4 lbs |  |

| Splash Guard Flexible                | Part No.      | Weight  |   |
|--------------------------------------|---------------|---------|---|
| 9.4"/23"/1.1", bracket version round | <b>90.077</b> | 0.2 lbs |  |

More products see splash guard page.

| Swivel for HP Wand          | Part No.      | Weight  |   |
|-----------------------------|---------------|---------|---|
| IN 3/8" NPTM, OUT 3/8" NPTF | <b>32.564</b> | 0.7 lbs |  |

More products see swivel pages.

| DGV Heat Shield  | Part No.      | Weight   |   |
|--|---------------|----------|---|
| PA, black, screw included, minimum order quantity 15 pcs | <b>28.973</b> | 0.08 lbs |  |

| Wand Holder Bracket  | Part No.      | Weight  |   |
|--|---------------|---------|---|
| for wall mounting<br>suitable for 29.097 / 29.028 / 29.113 / 29.121, size 6.3"/6.3"/6.3" | <b>29.099</b> | 4.2 lbs |  |

| Wands  | Part No.      | Weight  |   |
|--|---------------|---------|---|
| chemical spray wand, swiveling, 35.4", IN Ø1/4" M, max. 120°F, max. 1500 psi, max. 8 gpm | <b>28.560</b> | 0.8 lbs |  |
| Koax spray pipe, 39"<br>IN M21x1.5 F, OUT 2x 1/8" NPTF                                   | <b>16219</b>  | 2.4 lbs |   |
| Vario spray pipe, 39"<br>IN M21x1.5 F, OUT 1x 1/8" NPTF                                  | <b>16227</b>  | 2.0 lbs |   |

| Weep System  | Part No.      | Weight  |   |
|--|---------------|---------|---|
| closure pressure ~70-120 psi<br>flow rate ~0.25 gpm at ~60 psi |               |         |  |
| ø0.4", 90 psi 2.4 gpm, 1500 psi 9.0 gpm                        | <b>29.031</b> | 0.1 lbs |   |
| ø0.3", 90 psi 0.8 gpm, 1500 psi 3.4 gpm                        | <b>29.032</b> | 0.1 lbs |   |

| Wheelblaster Pro                             | Part No.       | Weight   |   |
|--|----------------|----------|---|
| Extension for stand pole, 39"                | <b>84.907</b>  | 13.2 lbs |  |
| Stand pole, 39"                              | <b>903.986</b> | 15.7 lbs |  |
| Cleaning head, ø5.5", 4 1/4"<br>IN 3/8" NPTF | <b>84.586</b>  | 9.3 lbs  |  |
| Cleaning head, ø10", 6 1/8"<br>IN 3/8" NPTF  | <b>84.596</b>  | 11.2 lbs |  |
| Stabilizer nozzle, 1/4" NPTM, 3.7"           | <b>14.901</b>  | 0.2 lbs  |  |
| Stabilizer nozzle, 1/8" NPTM, 3.7"           | <b>14.902</b>  | 0.2 lbs  |   |
| Stabilizer nozzle, 1/8" NPTM, 2.7"           | <b>14.935</b>  | 0.2 lbs  |   |
| Stabilizer nozzle, 1/4" NPTM, 2.8"           | <b>14.939</b>  | 0.2 lbs  |   |

Legend

M. = metric thread, .M = male, F = female, Ø = gas pipe thread, R = gas pipe thread conical, DV = quick connect, SV = profile ring fitting  
 D = diameter, L = length, NW = nominal width, SW = wrench size, IN = male input, OUT = male output, RG = basic position



- ✓ Polished stainless steel
- ✓ With mounting plate
- ✓ 4 nozzles inlets
- ✓ High quality swivel



Mosmatic Wheelblasters are a versatile and highly effective cleaning solution for almost any style vehicle or equipment cleaning. The rotation speed is determined by the water and pressure which drives the rotor arm. These products are mainly found in automatic car wash facilities in the area of tire/rim and rocker panel cleaning. It is an efficient and reliable touch free method of achieving optimal cleaning results.

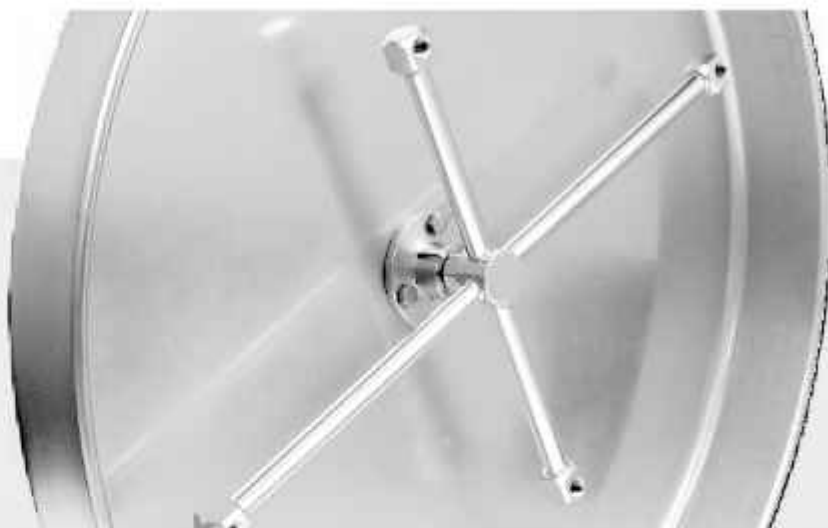

### WBL ø21"

| Part No. | Swivel | Rotor Arm | Weight   |
|----------|--------|-----------|----------|
| 84.504   | DYF    | 16"/10"   | 13.8 lbs |
| 84.514   | DYF    | 18.5"/14" | 16.1 lbs |
| 84.509   | DYT    | 16"/10"   | 18.5 lbs |
| 84.519   | DYT    | 18.5"/14" | 18.7 lbs |

Requires 4x 1/8" nipples, please order separately

DYF: triple-bearing system, DYT: quadruple-bearing system

#### TECHNICAL DATA

|                   |                     |
|-------------------|---------------------|
| Pressure          | 4000 psi (27.5 MPa) |
| Temperature       | 250°F               |
| RPM               | up to 2000 rpm      |
| Water connection  | 3/8" NPTF           |
| Nozzle connection | 4x 1/8" NPTF        |
| Throughput medium | pH 3-12             |

#### Legend

M... = metric thrust, ...M = male, F = female, B = gas side thrust, R = gas side thrust/central, QV = quick connects, SV = profile ring fitting  
 Ø = diameter, L = length, NW = nominal width, SW = wrench size, IN = male input, OUT = male output, RB = basic position

- ✓ Equipped with stabilizer nozzles
- ✓ Assembly on both sides possible
- ✓ Flexible installation options
- ✓ Adjustable spray direction
- ✓ Polished stainless steel (INOX)



Due to the compact design, this wheelblaster is ideal for installs where there is only limited space. The unit comes equipped with four stabilizer nozzles. These stabilizer nozzles increase distance and impact and the spray direction is adjustable to achieve optimal cleaning. Choose the correct EG nozzle to match your pump.



## WBC

| Part No. | Swivel | IN       | Rotor arm | Stabilizer Nozzles | Insert Nozzle | Weight  |
|----------|--------|----------|-----------|--------------------|---------------|---------|
| 84.607   | DYTiS  | 3/8"NPTF | 4 1/4"    | 4x 14.902          | ---           | 9.0 lbs |
| 84.608   | DYTiS  | 1/2"NPTF | 4 1/4"    | 4x 14.902          | ---           | 9.0 lbs |
| 84.609   | DYTiS  | 3/4"NPTF | 4 1/4"    | 4x 14.902          | ---           | 9.3 lbs |

\* Requires 4x EG nozzles, according to your pump specifications

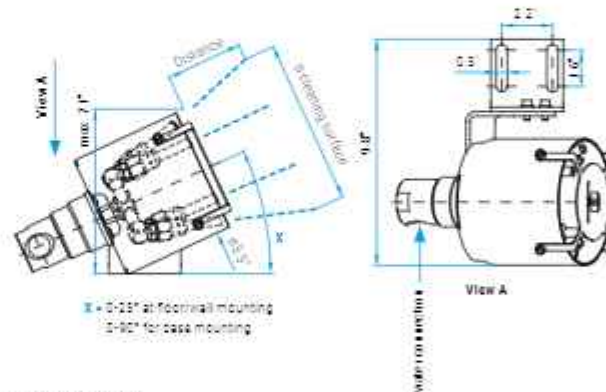

### Action diameter

| Distance | Cleaning surface |
|----------|------------------|
| 10"      | 12"              |
| 20"      | 20"              |
| 30"      | 28"              |
| 40"      | 33"              |



## Stabilizer Nozzle

(without insert nozzle)

| Part No. | IN        |
|----------|-----------|
| 14.902   | 1/8" NPTM |

### TECHNICAL DATA

|                   |                     |
|-------------------|---------------------|
| Pressure          | 4000 psi (27,5 MPa) |
| Temperature       | 250°F               |
| RPM               | up to 2000 rpm      |
| Throughput medium | pH 3-12             |

### Legend

M. = metric thrust, .M = male, F = female, B = gas pipe thrust, R = gas pipe thrust control, QV = quick connect, SV = profile ring fitting, D = diameter, L = length, NW = nominal width, SW = insertion size, IN = media input, OUT = media output, RG = basic position

- ✓ Polished stainless steel
- ✓ Equipped with stabilizer nozzles
- ✓ Seamless height and angle adjustable
- ✓ Multiple cleaning heads can be installed
- ✓ High impact at distance

The Mosmatic Wheelblaster Pro is the new "must have" for vehicle wash systems. The wash head is movable and the desired cleaning angle and height can be selected according to the application. The unit comes equipped with 4 stabilizer nozzles. That increases the distance and impact to achieve optimal cleaning. It is possible to cover a larger cleaning area by mounting various cleaning heads on the 39" high stand. Choose the correct EG nozzle to match your pump. (The four 0° tips inserts are sold separately)

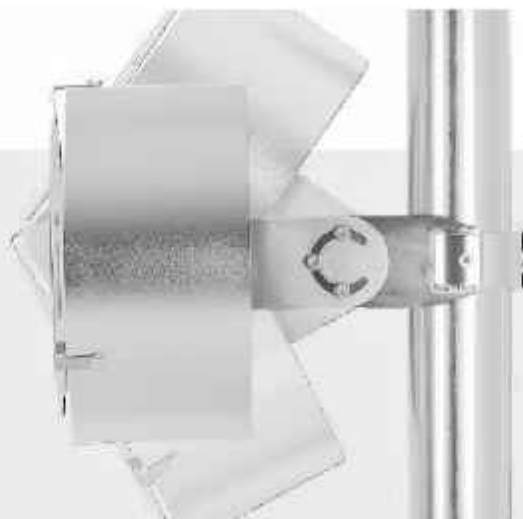

84.907

84.546



84.586

### WBP with Stand

| Part No. | Swivel | IN        | Diameter | Rotor arm | Stabilizer Nozzles | Insert Nozzle | Weight   |
|----------|--------|-----------|----------|-----------|--------------------|---------------|----------|
| 84.546   | DVTis  | 3/8" NPTF | ø10"     | 6"/6"     | 4x 14.901          | ---           | 27.0 lbs |

\* Requires 4x EG-nozzles, according to your pump specifications

### WBP without Stand

| Part No. | Swivel | IN        | Diameter | Rotor arm | Stabilizer Nozzles | Insert Nozzle | Weight   |
|----------|--------|-----------|----------|-----------|--------------------|---------------|----------|
| 84.586   | DVTis  | 3/8" NPTF | ø5.5"    | 4"/4"     | 4x 14.902          | ---           | 9.3 lbs  |
| 84.587   | DVTis  | 1/2" NPTF | ø5.5"    | 4"/4"     | 4x 14.902          | ---           | 9.3 lbs  |
| 84.588   | DVTis  | 3/4" NPTF | ø5.5"    | 4"/4"     | 4x 14.902          | ---           | 9.5 lbs  |
| 84.589   | DVF    | 3/8" NPTF | ø5.5"    | 4"        | 2x 14.902          | ---           | 7.5 lbs  |
| 84.596   | DVTis  | 3/8" NPTF | ø10"     | 6"/6"     | 4x 14.901          | ---           | 11.2 lbs |
| 84.597   | DVTis  | 1/2" NPTF | ø10"     | 6"/6"     | 4x 14.901          | ---           | 11.2 lbs |
| 84.598   | DVTis  | 3/4" NPTF | ø10"     | 6"/6"     | 4x 14.901          | ---           | 11.5 lbs |
| 84.599   | DVF    | 3/8" NPTF | ø10"     | 6"        | 2x 14.901          | ---           | 11.0 lbs |

\* Requires 4x EG-nozzles; \*\* Requires 2x EG-nozzles, according to your pump specifications

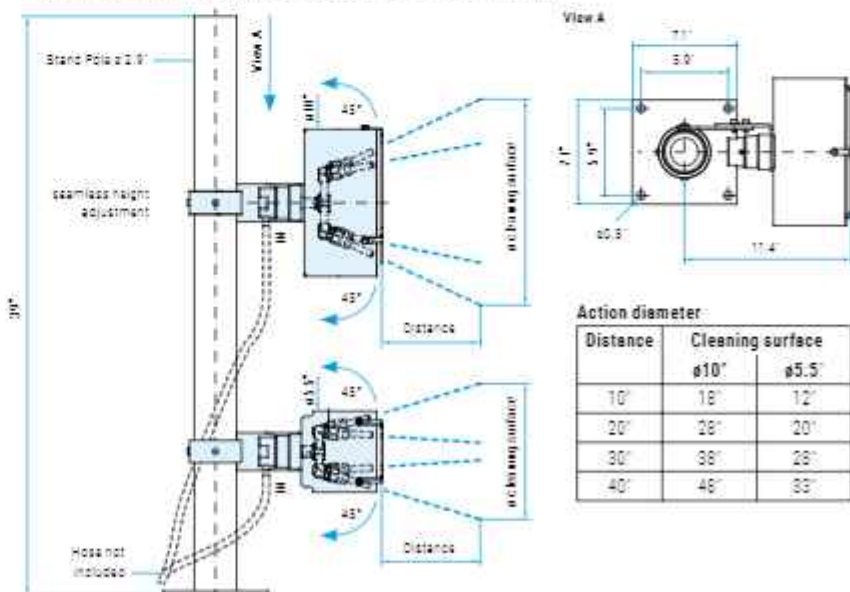

#### Action diameter

| Distance | Cleaning surface ø10" | Cleaning surface ø5.5" |
|----------|-----------------------|------------------------|
| 10"      | 18"                   | 12"                    |
| 20"      | 26"                   | 20"                    |
| 30"      | 36"                   | 26"                    |
| 40"      | 46"                   | 33"                    |

### Extension

| Part No. | Length | Weight   |
|----------|--------|----------|
| 84.907   | 39"    | 13.2 lbs |

### Stand Pole

| Part No. | Length | Weight   |
|----------|--------|----------|
| 903.986  | 39"    | 15.0 lbs |

#### TECHNICAL DATA

|                   |                     |
|-------------------|---------------------|
| Pressure          | 4000 psi (27.5 MPa) |
| Temperature       | 250°F               |
| RPM               | up to 2000 rpm      |
| Throughput medium | pH 3-12             |

#### Legend

M. = metric thrust, L.M = male, F = female, Ø = gas side thrust, R = gas side thrust optional, QV = quick connects, SW = profile ring fitting, D = diameter, L = length, NW = nominal width, SW = wrench size, IN = male inlet, OUT = male outlet, RB = basic position



# UNDERCARRIAGE CLEANER STATIONARY

- ✓ Compact and solid construction
- ✓ Equipped with stabilizer nozzles
- ✓ Modular design

The TUW stationary is perfect for fixed ramp over or sub-floor undercarriage wash systems. Industrial grade stainless plates and boxes come complete with quad bearing swivels and welded balanced rotor arms. The high lift wash design removes heavy debris and cleans without damage to the vehicles undercarriage. Whether a new install or system upgrade this is sure to impress.



## TUWs

| Part No. | Dimensions (L/W/H) | Weight   | Swivels | Rotor arms | Stabilizer Nozzles | Nozzles |
|----------|--------------------|----------|---------|------------|--------------------|---------|
| 80.640   | 29.5"x11.8"x10.8"  | 78.5 lbs | 2x DVT  | 8"/10"     | 4x 14.901          | —       |

\* Requires 4x 80-nozzles, according to your pump specifications

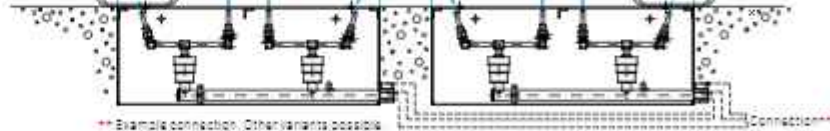
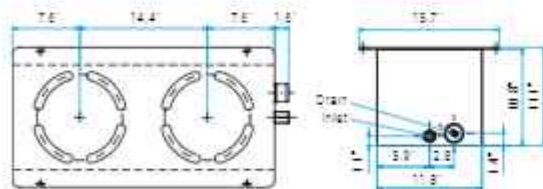
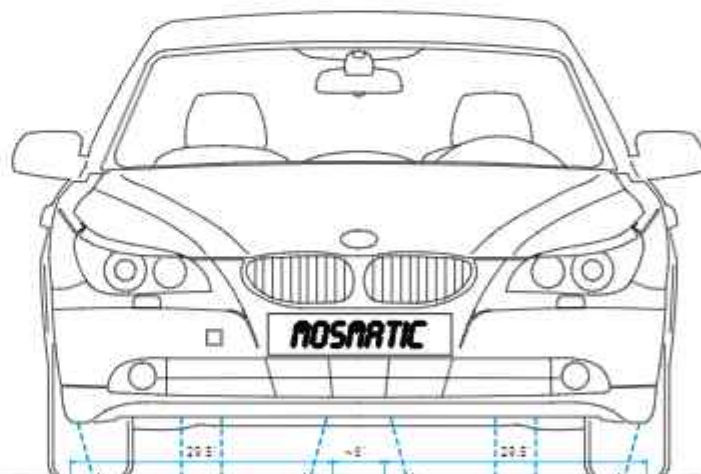

### Action diameter

| Distance from ground | Cleaning surface |
|----------------------|------------------|
| 4"                   | φ 12"            |
| 8"                   | φ 16"            |
| 12"                  | φ 18"            |



### Stabilizer Nozzle

(without insert nozzle)

| Part No. | IN        |
|----------|-----------|
| 14.901   | 1/4" NPTM |

### TECHNICAL DATA

|                   |                     |
|-------------------|---------------------|
| Pressure          | 4000 psi (27.5 MPa) |
| Temperature       | 250°F               |
| RPM               | up to 2000 rpm      |
| Body              | 29.5"x11.8"x10.8"   |
| Water connection  | 3/4" NPTF           |
| Water drain       | 2"                  |
| Throughput medium | pH 3-12             |

### Legend

M. = metric thrust, .M = male, F = female, B = gas pipe thrust, R = gas pipe thrust conical, DV = quick connects, SV = profile ring fitting, D = diameter, L = length, NW = nominal width, SW = insertion size, IN = male input, OUT = male output, RG = basic position

# UNDERCARRIAGE CLEANER WITH RAMP



- ✓ Mobile undercarriage cleaning
- ✓ Easy and fast assembly
- ✓ 100% stainless steel
- ✓ Only 4.7" in height

This undercarriage cleaner from Mosmatic is the first of its kind using patented technology and only 4.7" in height. It will help prolong the life of your vehicles and fleets making them safer for service and maintenance. This all stainless constructed mat can easily be assembled with simple tools in minutes and can be anchored or mobile. Easily adapts to pressure washer pump systems from 5 gpm to 20 gpm, works with hot or cold water systems and chemicals from pH 3-12.

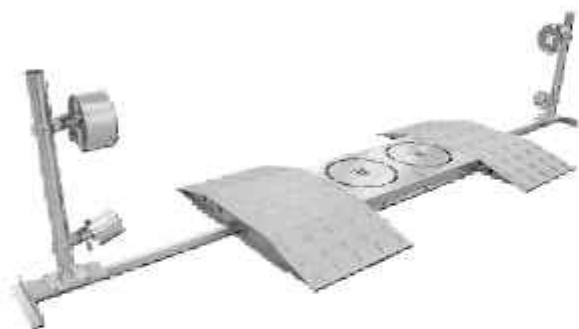
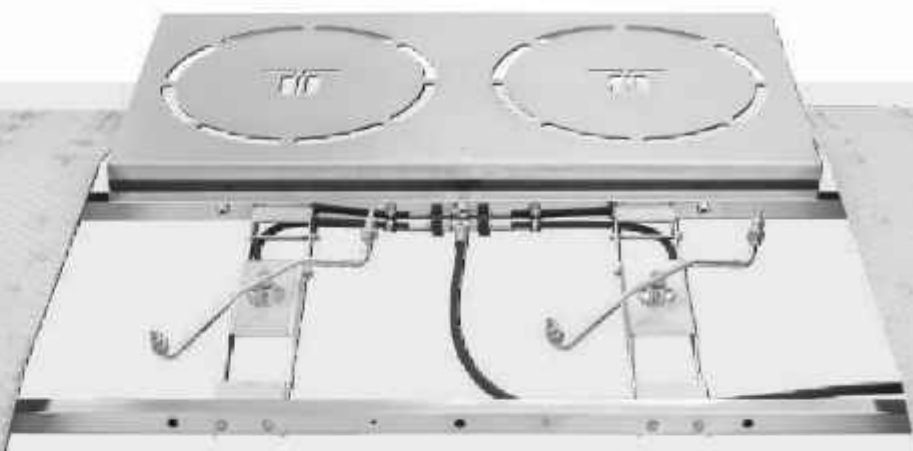

## Undercarriage Cleaner with Ramp

| Name                                   | Part No. | Piece | Length  | Width    | Height | Weight  |
|--|----------|-------|---------|----------|--------|---------|
| Undercarriage Cleaner with Ramp Set-up | 80.506   | 1x    | 4' 9.6" | 16' 5.6" | 4.7"   | 312 lbs |

Includes:

|                   |         |    |         |         |      |          |   |
|-------------------|---------|----|---------|---------|------|----------|---|
| Ramp              | 80.508  | 1x | 4' 9.6" | 8' 9.7" | 4.7" | 378 lbs  | 1 |
| Rigger            | 80.550  | 2x | 4'      | 1' 3.8" | 2.6" | 20.9 lbs | 2 |
| Low Volume WBP140 | 84.589  | 2x | ---     | ---     | ---  | 7.7 lbs  | 3 |
| Low Volume WBP250 | 84.599  | 2x | ---     | ---     | ---  | 10.5 lbs | 4 |
| Stand             | 903.986 | 2x | 3' 3.4" | ---     | ---  | 16.1 lbs | 5 |

Accessories:

|                       |         |    |         |         |          |          |   |
|-----------------------|---------|----|---------|---------|----------|----------|---|
| Extension             | 84.907  | 2x | 3' 3.4" | ---     | ---      | 13.2 lbs | 6 |
| Collision protection  | 905.884 | 1x | 2' 10"  | 6"      | 4"       | 17.6 lbs | 7 |
| High performance Pump | 80.561  | 1x | 3' 8.5" | 2' 7.5" | 6' 10.3" | 1100 lbs | 8 |
| Hose kit              | 80.560  | 1x | ---     | ---     | ---      | 27.6 lbs | 9 |

Consult your local laws for rules and regulations for wastewater runoff.

Our vehicles and fleets are valuable assets that are exposed to the influences of nature, chemicals and pollution. This leads to significant wear and tear on the chassis, wear parts and body. Keeping the undercarriage of your vehicle clean prevents rust and corrosion, reducing cost and prolonging component life.



Part No. 80.561 High performance Pump, information on request.



Part No. 80.513 Double ramp, information on request.

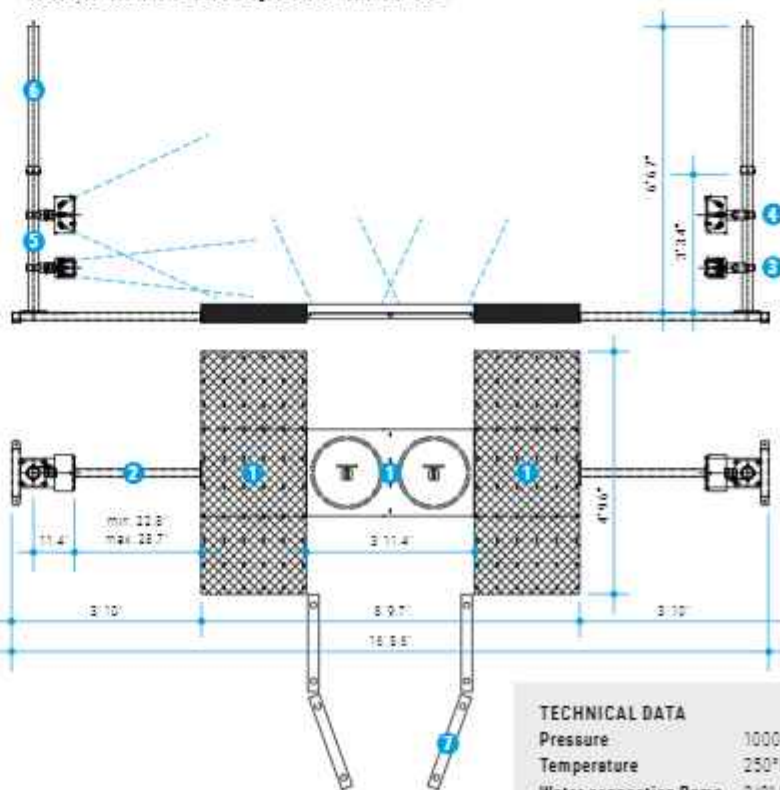

### TECHNICAL DATA

|                       |                  |
|-----------------------|------------------|
| Pressure              | 1000 psi (7 MPa) |
| Temperature           | 250°F            |
| Water connection Ramp | 3/8" NPTM        |
| Water connection WBP  | 4x 3/8" NPTF     |
| Throughput medium     | pH 3-12          |
| min. ground clearance | 4.8"             |

### Legend

M... = metric thrust, ...M = male, F = female, B = gas side thrust, R = gas side thrust conical, QV = quick connects, SV = profile ring fitting, D = diameter, L = length, NW = nominal width, SW = wrench size, IN = male input, OUT = male output, RB = basic position

- ✓ Delivered ready to install
- ✓ A must for every pay station
- ✓ Protects the coin slot

Mosmatic splash guards are a must to prevent water from entering into pay station coin/card slots causing unwanted damage. Choose between the standard version and the flexible version. The flexible version has spring-loaded mounting, adding extra endurance. Existing units already equipped with a Mosmatic splash guard, can be easily upgraded to the new system.

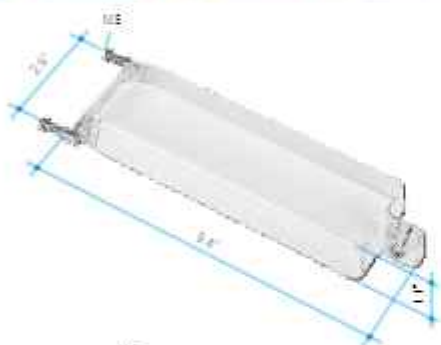

### Splash guard flexible

transparent Polycarbonate, INOX mounting brackets

| Part No. | Bracket version | Stopper | Weight  |
|----------|-----------------|---------|---------|
| 90.077   | round           | magnet  | 0.2 lbs |
| 90.096   | round           | rubber  | 0.2 lbs |



### Splash guard standard

transparent Polycarbonate, INOX mounting brackets

| Part No. | Bracket version | Stopper | Weight  |
|----------|-----------------|---------|---------|
| 90.015   | round           | magnet  | 0.2 lbs |
| 90.076   | angular         | magnet  | 0.2 lbs |



### Splash guard short

transparent Polycarbonate, INOX mounting brackets

| Part No. | Bracket version | Stopper | Weight  |
|----------|-----------------|---------|---------|
| 90.071   | round           | ---     | 0.2 lbs |

#### Legend

M... = metric thrust, ...M = male, F = female, B = gas pipe thrust, R = gas pipe thrust control, QV = quick connects, SV = profile ring fitting, D = diameter, L = length, NW = nominal width, SW = wrench size, IN = male input, OUT = male output, RG = basic position



- ✓ Available with weep option
- ✓ Ergonomically molded
- ✓ Low Trigger Force Technology

Mosmatic offers a wide variety of high pressure guns. From our Low Trigger Force guns that offer 90% reduced holding and 40% less trigger force to models with built in live swivels. Standard and Weep model designs are also available.



**Mosmatic HP Gun «Aero»**

Pressure: 4000 psi, Temperature: 300°F  
IN 3/8" NPTF, OUT 1/4" NPTF

| Part No. | Weep | Weight  |
|----------|------|---------|
| 29.034   | yes  | 1.1 lbs |
| 29.045   | no   | 1.1 lbs |

**Mosmatic HP Gun «Nano»**

Pressure: 4000 psi, Temperature: 300°F  
IN 3/8" NPTF, OUT 1/4" NPTF

| Part No. | Weep | Groove | Weight  |
|----------|------|--------|---------|
| 29.063   | ---  | ---    | 1.8 lbs |
| 29.082   | yes  | yes    | 1.8 lbs |

IN 3/8" F, OUT 1/4" F

| Part No. | Weep | Groove | Free flow | Weight  |
|----------|------|--------|-----------|---------|
| 29.967   | ---  | ---    | yes       | 1.6 lbs |



**Mosmatic HP Gun «Neo»**

Temperature: 300°F  
IN 3/8" NPTF, OUT 1/4" NPTF

| Part No. | Weep | LTF | Swivel | Pressure | Color  | Weight  |
|----------|------|-----|--------|----------|--------|---------|
| 29.081   | ---  | yes | ---    | 5000 psi | purple | 1.3 lbs |
| 29.132   | ---  | yes | yes    | 5000 psi | purple | 1.3 lbs |
| 29.134   | yes  | yes | yes    | 5000 psi | purple | 1.3 lbs |
| 29.142   | yes  | yes | ---    | 5000 psi | purple | 1.3 lbs |
| 29.147   | yes* | yes | ---    | 5000 psi | purple | 1.3 lbs |
| 29.162   | ---  | --- | yes    | 4000 psi | orange | 1.3 lbs |
| 29.164   | yes  | --- | yes    | 4000 psi | orange | 1.3 lbs |

**Mosmatic HP Gun «Neo»**

Temperature: 300°F  
IN 1/2" NPTF, OUT 1/2" NPTF

| Part No. | Pressure | Color | Weight  |
|----------|----------|-------|---------|
| 29.136   | 6700 psi | blue  | 1.5 lbs |

**HP Gun Repair Kit**

| Part No. | for HP Gun |
|----------|------------|
| 29.055   | Nano       |
| 29.146   | Neo        |

LTF = Low Trigger Force  
\* Perma-Flow

Legend

M. = metric thrust, L.M = male, F = female, Ø = gas side thrust, R = gas side thrust optional, QV = quick connects, SV = profile ring fitting  
D = diameter, L = length, NW = nominal width, SW = wrench size, IN = male input, OUT = male output, RB = basic position

**Our goal:**

**Providing solutions to solve today's cleaning and sanitation needs.**

# HIGH PRESSURE

## **Surface Cleaning and Maintenance**

Our complete range of surface cleaners, set the standard for today's commercial and industrial needs. Offering both recovery style and non, we are the perfect choice for large and small flatwork applications. Ergonomic, lightweight and durable designs make us the number one choice for your clean and sanitation needs.



## **Food Industry**

Today's industry calls for water conservation and higher sanitation requirements, Mosmatic components help increase cleaning efficiency while decreasing time and labor as well as reducing waste water.

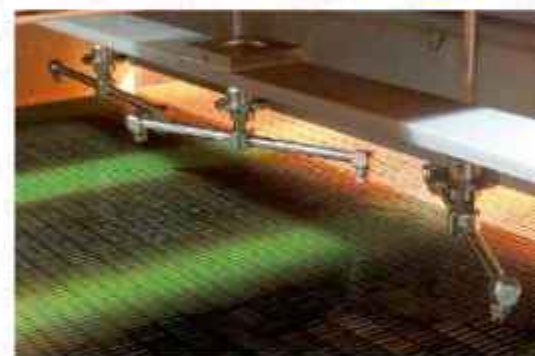

## **Municipal**

Working together with manufacturers of municipal vehicles, Mosmatic has developed solutions for the high demands of professional road and sidewalk cleaning. We also have the right components to bring in an economically friendly way to clean tunnels, shafts, ducts, pipes, noise protection walls and buildings.



## **Industrial Cleaning**

Mosmatic offers various cleaning tools for industries such as parts cleaning, shipbuilding, wood and metal processing but also for the cleaning of portable toilet cabins, silos, steam hoods and buildings. We offer products that are designed to withstand harsh environments and rugged daily use.





## GUM REMOVER

- ✓ Effective and efficient cleaning
- ✓ With fluid recovery port
- ✓ Gum remover bracket and trigger



### TECHNICAL DATA

|             |           |
|-------------|-----------|
| Pressure    | 5000 psi  |
| Temperature | 250°F     |
| Inlet       | 3/8" NPTF |



**FL-AHB-KAU 750**



**FL-AHB-KAU 520**

## FEATURES

### Chewing Gum remover

This special nozzle, uses it's own trigger gun to activate on chewing gum or persistent stains. The high pressure jets impact at a 45° angle to cut and lift the gum.

Available sizes: #3 (29.102), #4 (29.103), #5 (29.119)

Gum remover nozzle sold separately.



### Recovery System

Environmental protection is more important than ever, leading to the need to recycle waste water. The dual housing and vacuum port allow this function.

Residual water and debris can be recovered, recycled and reused.

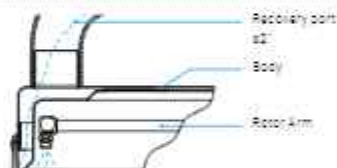

### Adjustable Height

Stainless steel frame for added stability. Optimize your cleaning results with the height adjustable housing.



### Stainless Steel Caster (Premium Quality)

Four 4" stainless steel casters with custom mounting brackets, ensure easy maneuvering even in confined spaces. Part No. 80.956

### Rotor Arms

Can withstand up to 7500 psi, and are precision welded and balanced.



### 2cp2 (2 Arms / 2 Nozzles)

Part No. 82.946 (ø18.5")

Optional: Part No. 82.9069 (ø17.7"), 1/8"

### 3cp3 (3 Arms / 3 Nozzles)

Part No. 82.947 (ø27.5")

### Quality Swivel

High rpm stainless steel swivel, features reinforced self-lubricated stainless steel ball bearings for improved performance. The dual spring based carbide seal system, guarantees long-lasting operation under tough conditions.



### DYCI Swivel

Part No. 55.253

| Name            | Part No. | ø   | Weight   | Swivel  | Rotor Arm    | HP-<br>Nozzles | HP-<br>Gun | Stainless<br>Steel<br>Caster |
|-----------------|----------|-----|----------|---------|--------------|----------------|------------|------------------------------|
| FL-AHB-KAU 520  | 80.786   | 21" | 44.0 lbs | 1x DYCI | 2x 1/8" NPTF | 2x 1503        | 2x         | 4x ø4"                       |
| FL-AHB-KAU 520* | 80.787   | 21" | 44.0 lbs | 1x DYCI | 2x 1/8" NPTF | 2x 1503        | 2x         | 4x ø4"                       |
| FL-AHB-KAU 750  | 80.788   | 30" | 58.5 lbs | 1x DYCI | 3x 1/8" NPTF | 3x 1503        | 2x         | 4x ø4"                       |

\* with plastic rim guard, no brush ring

Gum remover nozzle sold separately.



- ✓ Designed for professional cleaning
- ✓ With fluid recovery port
- ✓ High durability
- ✓ Height-adjustable



TECHNICAL DATA

- Pressure 5000 psi  
7300 psi
- Temperature 250°F
- Inlet 1/4" NPTM  
3/8" NPTF  
1/2" NPTF



FL-AH 750



FL-AH 520

FEATURES

Recovery System

Environmental protection is more important than ever, leading to the need to recycle waste water. The dual housing and vacuum port allow this function.

Residual water and debris can be recovered, recycled and reused.

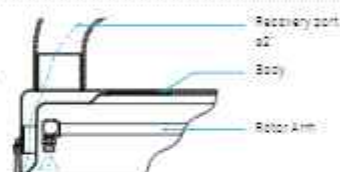

Adjustable Height

Stainless steel frame for added stability. Height adjustable housing ensures the best cleaning results.



Stainless Steel Caster (Premium Quality)

Four 4" stainless steel casters with custom mounting brackets ensure easy maneuvering even in confined spaces.  
Part No. 80,956

Rotor Arms

Can withstand up to 7300 psi and are precision welded and balanced.



2op2 (2 Arms / 2 Nozzles)

Part No. 82,946 (ø18.5"), 1/8"

Part No. 82,941 (ø18.5"), 1/4"

Optional: Part No. 82,9069 (ø17.7"), 1/8"

3op3 (3 Arms / 3 Nozzles)

Part No. 82,947 (ø27.5"), 1/8"

4op4 (4 Arms / 4 Nozzles)

Part No. 82,9133 (ø18.5"/19.8"), 1/4"

Part No. 82,9108 (ø27"/23.6"), 1/4"

Quality Swivel

High rpm stainless steel swivel features reinforced self lubricated stainless steel ball bearings for improved performance. The dual spring based carbide seal system, guarantees long lasting operation under tough conditions.



DYCI Swivel

Part No. 55,253

DXTI Swivel

Part No. 39,910

DYDI Swivel (7300 psi)

Part No. 55,263

| Name         | Part No. | ø   | NW   | Weight   | Swivel  | Rotor Arm    | HP-<br>Nozzles | HP-<br>Gun | Stainless<br>Steel<br>Caster |
|--------------|----------|-----|------|----------|---------|--------------|----------------|------------|------------------------------|
| FL-AH 520    | 80,784   | 21" | 1/4" | 38.5 lbs | 1x DYCI | 2x 1/8" NPTF | 2x 1503        | 1x         | 4x ø4"                       |
| FL-AH 520*   | 80,797   | 21" | 1/2" | 44.0 lbs | 1x DXTI | 4x 1/4" NPTF | 4x 1503        | 1x         | 4x ø4"                       |
| FL-AHY 520** | 80,189   | 21" | 1/4" | 37.5 lbs | 1x DYDI | 2x 1/8" NPTF | --             | --         | 4x ø4"                       |
| FL-AH 750    | 80,785   | 30" | 1/4" | 51.8 lbs | 1x DYCI | 3x 1/8" NPTF | 3x 1503        | 1x         | 4x ø4"                       |
| FL-AH 750*   | 80,798   | 30" | 1/2" | 57.3 lbs | 1x DXTI | 4x 1/4" NPTF | 4x 1503        | 1x         | 4x ø4"                       |
| FL-AHY 750** | 80,389   | 30" | 1/4" | 50.7 lbs | 1x DYDI | 3x 1/8" NPTF | --             | --         | 4x ø4"                       |

\* Inlet 1/2" NPTF \*\* Pressure: 7300 psi / Inlet 1/4" NPTM

- ✓ With fluid recovery port
- ✓ Integrate high quality swivel
- ✓ Ready to use

Mosmatic Allrounder with recovery is ideal for smaller and hard to reach areas both indoors and out. Small compact and lightweight design is ideal for jobs large or small. Using your vac system, water can be recovered, reused or discharged.



**TECHNICAL DATA**

Pressure 4000 psi  
 Temperature 250°F  
 Inlet 3/8" NPTF

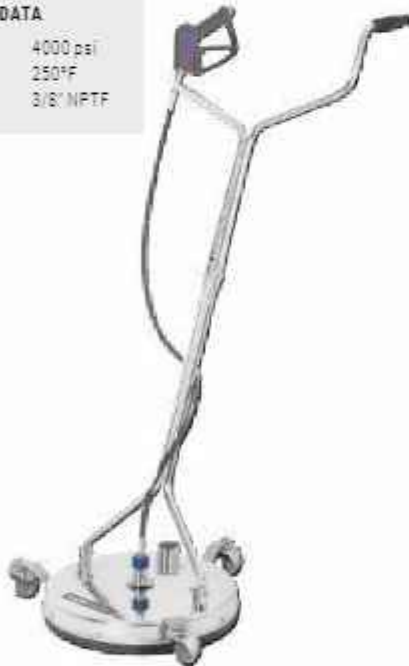

**FL-AER 410**



**FL-AER 300**

**FL-AER 200**

**FL-AEB 200**

**FEATURES**

**Recovery System**

Environmental protection is more important than ever. These recovery units have a double wall housing to optimize vacuum power.

Residual water and debris can be recovered, recycled and reused.

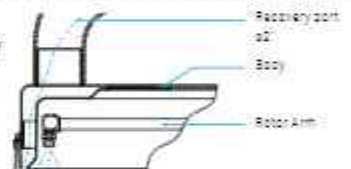

**Rotor Arms**

Can withstand up to 4000 psi, are precision welded and balanced.



**2w2 (2 Arms / 2 Nozzles)** - **2w2 (2 Arms / 2 Nozzles)** - **2w2 (2 Arms / 2 Nozzles)**  
 Part No. 82.621 (ø5") Part No. 82.623 (ø10") Part No. 82.625 (ø14")

**Proven innovation**

Developed by Mosmatic and in service for years, the toggle swivel has proven itself. The toggle joint feature allows effortless cleaning of walls and angled surfaces. The movement of the joint is adjustable for fatigue free cleaning.



**KDYF Toggle Swivel**

Part No. 58.908

**Quality Swivel**

High rpm stainless steel swivel, features reinforced self lubricated stainless steel ball bearings for improved performance. The dual spring based carbide seal system, guarantees long lasting operation under tough conditions.



**DYF Swivel**

Part No. 58.000 (ø8") Part No. 58.250 (ø16")

**Stainless Steel Caster**

Heavy duty ø2 1/2" casters with custom mounting brackets ensure easy maneuvering even in confined spaces.



**Stainless Steel Caster** Caster for ø8"  
 Part No. 80.943 Part No. 80.922

| Name       | Part No. | ø"  | Weight   | Swivel  | Rotor Arm    | Nozzles | HP-Gun | Wheels     |
|------------|----------|-----|----------|---------|--------------|---------|--------|------------|
| FL-AEB 200 | 78.280   | 8"  | 6.2 lbs  | 1x DYF  | 2x 1/8" NPTF | 2x 1503 | 1x     | -          |
| FL-AER 200 | 78.290   | 8"  | 9.2 lbs  | 1x KDYF | 2x 1/8" NPTF | 2x 1503 | 1x     | 3x ø1 1/4" |
| FL-AER 300 | 78.292   | 12" | 12.3 lbs | 1x KDYF | 2x 1/8" NPTF | 2x 1503 | 1x     | 3x ø2 1/4" |
| FL-AER 410 | 78.299   | 16" | 20.0 lbs | 1x DYF  | 2x 1/8" NPTF | 2x 1503 | 1x     | 3x ø2 1/4" |

- ✓ Integrated Recovery
- ✓ Temperatures up to 250°F
- ✓ Integrate high quality toggle swivel
- ✓ Ready to use



## TECHNICAL DATA

|             |           |
|-------------|-----------|
| Pressure    | 4000 psi  |
| Temperature | 250°F     |
| Inlet       | 3/8" NPTF |



FL-SAR

## FEATURES

**Integrated recovery**

The black anodized aluminum suction device collects the dirty water via the Venturi and double housing principle. Mount your export hose on the suction device and place it into the desired port to drain the water. The use of a vacuum system is no longer needed.

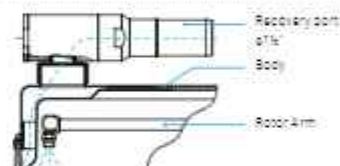
**Rotor Arms**

Can withstand up to 4000 psi, are precision welded and balanced.

**2w2 (2 Arms / 2 Nozzles)**

Part No. 82.623 (p10)

**Quality Swivel**

High rpm stainless steel swivel features reinforced self-lubricated stainless steel ball bearings for improved performance. The dual spring based carbide seal system, guarantees long lasting operation under tough conditions.

**KDYF Toggle Swivel**

Part No. 58.912

**Stainless Steel Caster**

Heavy duty ø2" casters with custom mounting brackets ensure easy maneuvering even in confined spaces.

**Stainless Steel Caster**

Part No. 80.943

| Name       | Part No. | ø   | Weight | Swivel  | Rotor Arm    | Nozzles          | HP-Gun | Casters |
|------------|----------|-----|--------|---------|--------------|------------------|--------|---------|
| FL-SAR 300 | 78.293   | 12" | 13 lbs | 1x KDYF | 2x 1/8" NPTF | 2x 1503 / 1x #3* | 1x     | 3x ø2"  |

## Accessories

| Name            | Part No. | Nozzles          |
|-----------------|----------|------------------|
| Nozzles package | 78.983   | 2x 1502 / 1x #2* |

\* #2 and #3 internal nozzles self recovery



- ✓ **Integrated Recovery**
- ✓ **Temperatures up to 250°F**
- ✓ **High durability**
- ✓ **Multifunctional**

The new Mosmatic Aqua Pro with an integrated water recovery system. This surface cleaner does not require an external industrial vacuum. Thanks to the venturi nozzle that is attached directly to the housing, wastewater can be discharged with a standard vac hose. The Aqua Pro can clean and recover individually, or both at the same time.



**TECHNICAL DATA**

**Pressure** 5000 psi  
**Temperature** 250°F  
**Inlet** 3/8" NPTF

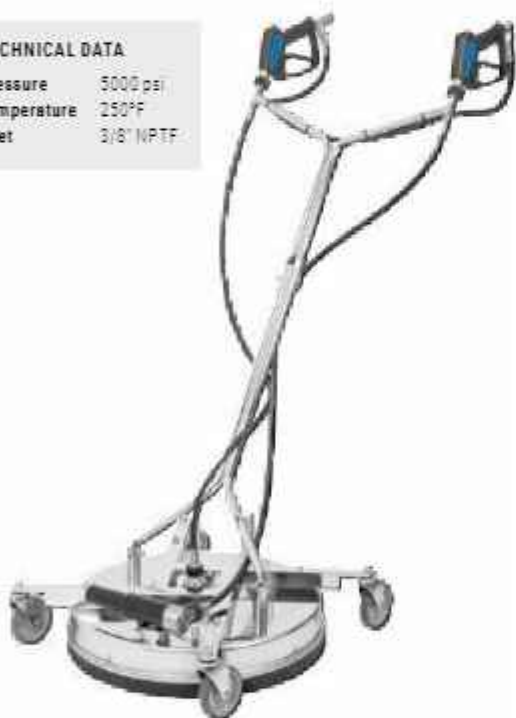

**FEATURES**

**Integrated recovery**

The black anodized aluminum suction device collects the wastewater via the Venturi and double housing principle. Mount your export hose on the suction device and place it into the desired port to drain the water. The use of a vacuum system is no longer needed.

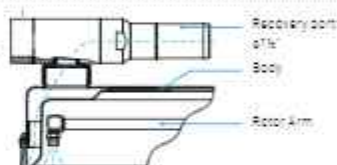

**Rotor Arms**

Can withstand up to 5000 psi, are precision welded and balanced.



**2cp2 (2 Arms / 2 Nozzles)**

Part No. 82.946 (ø18.5")

**Quality Swivel**

High rpm stainless steel swivel, features reinforced self lubricated stainless steel ball bearings for improved performance. The dual spring based carbide seal system, guarantees long lasting operation under tough conditions.



**DYCI Swivel**

Part No. 55.253

**Adjustable Height**

Stainless steel frame for added stability. Optimize your cleaning results with the height adjustable housing.



**Stainless Steel Caster (Premium Quality)**

Four 4" stainless steel casters with custom mounting brackets, ensure easy maneuvering even in confined spaces.  
 Part No. 80.956

**HP Guns**

1. HP-Gun • high pressure cleaning
2. HP-Gun • recovery function



| Name              | Part No.      | ø   | Weight | Swivel  | Rotor Arm    | Nozzles          | HP-Gun | Casters |
|-------------------|---------------|-----|--------|---------|--------------|------------------|--------|---------|
| <b>FL-SAR 520</b> | <b>80.789</b> | 21" | 44 lbs | 1x DYCI | 2x 1/8" NPTF | 2x 1503 / 1x #3* | 2x     | 4x ø4"  |

**Accessories**

| Name                   | Part No.      | Nozzles          |
|------------------------|---------------|------------------|
| <b>Nozzles package</b> | <b>78.983</b> | 2x 1502 / 1x #2* |

\* #2 and #3 internal nozzles self recovery

- ✓ With fluid recovery port
- ✓ Ready to use
- ✓ Designed for higher pressures



The Graffiti remover has an upgraded swivel and rotor arm for more industrial applications such as graffiti removal. It is also used in restoring a wide variety of surfaces, as well as indoor and outdoor contract cleaning.



### TECHNICAL DATA

Pressure 5000 psi  
 Temperature 250°F  
 Inlet 3/8" NPTF



**FL-ABB 300**



**FL-ABB 200**

## FEATURES

### Recovery System

Environmental protection is more important than ever. These recovery units have a double wall housing to optimize vacuum power.

Residual water and debris can be recovered, recycled and reused.

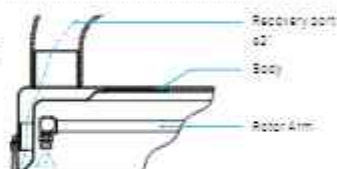

### Rotor Arms

Can withstand up to 7300 psi, are precision welded and balanced.



### 2p2 (2 Arms / 2 Nozzles)

Part No. 82.9051 (ø6") Part No. 82.323 (ø10")

### Brush Ring

Ideal for outdoor applications such as concrete, brick, limestone or wood surfaces.



### Plastic rim guard

Indoor use, prevents dirt and debris from building up on the rim. Adheres to purity regulation in the food and clinical industries.

### Quality Swivel

High rpm stainless steel swivel features reinforced self-lubricated stainless steel ball bearings for improved performance. The dual spring based carbide seal system, guarantees long lasting operation under tough conditions.



### DYW Swivel

Part No. 55.020

| Name        | Part No. | ø   | Weight  | Swivel | Rotor Arm    | HP-Nozzles | HP-Gun |
|-------------|----------|-----|---------|--------|--------------|------------|--------|
| FL-ABB 200  | 78.285   | 8"  | 6.0 lbs | 1x DYW | 2x 1/8" NPTF | 2x 1503    | 1x     |
| FL-ABB 200* | 78.286   | 8"  | 6.2 lbs | 1x DYW | 2x 1/8" NPTF | 2x 1503    | 1x     |
| FL-ABB 300  | 78.287   | 12" | 7.1 lbs | 1x DYW | 2x 1/8" NPTF | 2x 1503    | 1x     |
| FL-ABB 300* | 78.288   | 12" | 7.3 lbs | 1x DYW | 2x 1/8" NPTF | 2x 1503    | 1x     |

\* with Plastic rim guard

- ✓ Added wand and holder
- ✓ Solid construction
- ✓ Height-adjustable
- ✓ Quality high pressure swivel



**TECHNICAL DATA**

Pressure 4000 psi  
 Temperature 250°F  
 Inlet 3/8" NPTF



**FL-PH 750**



**FL-PH 520**

**FEATURES**

**Two Tools In One**

The wand quick connects to the existing HP-gun allowing you to prep your surface, clean corners, rinse over spray and clean other hard to reach areas.



**Adjustable Height**

Stainless steel frame for added stability. Adjust to compensate for uneven surfaces.



**Stainless Steel Caster (Premium Quality)**

Four 4" stainless steel casters with custom mounting brackets ensure easy maneuvering even in confined spaces.  
 Part No. 80,956

**Rotor Arms**

Can withstand up to 4000 psi, are precision welded and balanced.



**2w2 (2 Arms / 2 Nozzles)**

Part No. 82,942 (ø18.5")

**3w3 (3 Arms / 3 Nozzles)**

Part No. 82,943 (ø27.5")

Optional: Part No. 82,9069 (ø17.7"), 1/8"

**Quality Swivel**

High rpm stainless steel swivel features reinforced self-lubricated stainless steel ball bearings for improved performance. The dual spring based carbide seal system, guarantees long lasting operation under tough conditions.



Part No. 55,253

| Name      | Part No. | ø   | Weight   | Swivel  | Rotor Arm    | Wand Nozzle | HP- Nozzles | HP- Gun | Stainless Steel Caster |
|-----------|----------|-----|----------|---------|--------------|-------------|-------------|---------|------------------------|
| FL-PH 520 | 80,774   | 21" | 35.7 lbs | 1x DVCf | 2x 1/8" NPTF | 1x 1508     | 2x 1503     | 1x      | 4x ø4"                 |
| FL-PH 750 | 80,775   | 30" | 49.6 lbs |         | 3x 1/8" NPTF | 1x 1508     | 3x 1503     |         |                        |



- ✓ Added wand and holder
- ✓ Solid construction
- ✓ Quality high pressure swivel
- ✓ Ready to use
- ✓ Easy to maneuver



### TECHNICAL DATA

Pressure 4000 psi  
 Temperature 250°F  
 Inlet 3/8" NPTF



**FL-PB 750**



**FL-PB 520**

## FEATURES

### Two Tools In One

The wand quick connects to the existing HP-gun allowing you to prep your surface, clean corners, rinse over spray and clean other hard to reach areas.



### Large caster

The quality stainless steel caster and the two pneumatic tires enables easy maneuvering over uneven surfaces like ramps, grates and textured surfaces.



### Rotor Arms

Can withstand up to 4000 psi, are precision welded and balanced.



### 2ow2 (2 Arms / 2 Nozzles)

Part No. 82.942 (\$16.5')

### 3ow3 (3 Arms / 3 Nozzles)

Part No. 82.943 (\$27.5')

Optional: Part No. 82.9059 (\$17.7'), 1/8"

### Quality Swivel

High rpm stainless steel swivel features reinforced self-lubricated stainless steel ball bearings for improved performance. The dual spring based carbide seal system, guarantees long lasting operation under tough conditions.



Part No. 55.253

| Name      | Part No. | to  | Weight   | Swivel      | Rotor Arm    | Wand Nozzle | HP- Nozzles | HP- Gun | Caster            |
|-----------|----------|-----|----------|-------------|--------------|-------------|-------------|---------|-------------------|
| FL-PB 520 | 80.679   | 21" | 49.6 lbs | 1x<br>-DVOI | 2x 1/8" NPTF | 1x 1506     | 2x 1508     | 1x      | 1x ø5"<br>2x ø10" |
| FL-PB 750 | 80.689   | 30" | 58.4 lbs |             | 3x 1/8" NPTF | 1x 1508     | 3x 1508     |         |                   |

- ✓ Also model up to 7300 psi available
- ✓ Low pressure option
- ✓ Maintenance free
- ✓ Quality stainless steel swivel
- ✓ Ready to use

The surface cleaner for cold and hot water application reaches peak performance without any maintenance. Our most popular flat surface cleaner, ideal for cleaning parking lots, gas stations, school yards, entrance halls etc.

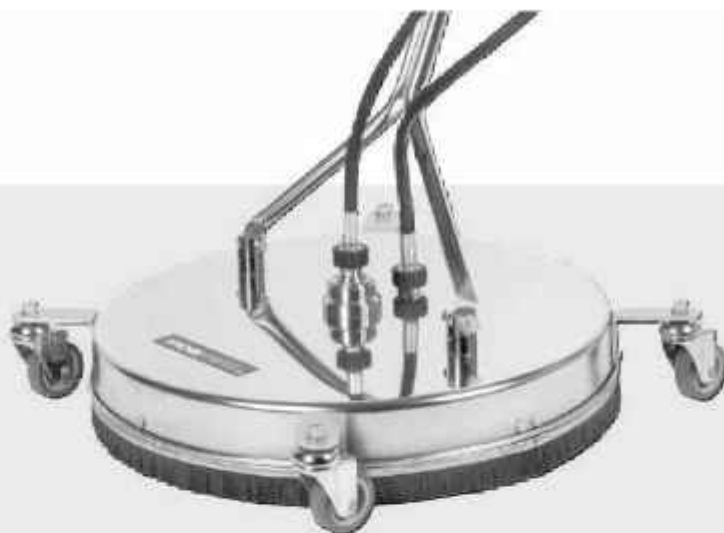

**TECHNICAL DATA**

Pressure 4000 / 7300 psi  
 Temperature 250°F  
 Inlet 3/8" NPTF  
 1/4" NPTM



**FL-CR 750**

**FEATURES**

**Rotor Arms**

Can withstand up to 7300 psi, are precision welded and balanced.

**2cw2** (2 Arms / 2 Nozzles) Part No. 82.942 (p18.5")  
**3cw3** (3 Arms / 3 Nozzles) Part No. 82.943 (p27.5")

**2cp2** (2 Arms / 2 Nozzles) Part No. 82.946 (p18.5"), 1/8", 7300 psi  
 Optional: Part No. 82.941 (p18.5"), 1/4", 7300 psi  
 Optional: Part No. 82.9059 (p17.7"), 1/8", 7300 psi

**3cp3** (3 Arms / 3 Nozzles) Part No. 82.947 (p27.5"), 1/8", 7300 psi



**Stainless Steel Caster**

Heavy duty 2" casters with custom mounting brackets ensure easy maneuvering even in confined spaces.



**Stainless Steel Caster**

Part No. 80.912

**Quality Swivel**

High rpm stainless steel swivel features reinforced self-lubricated stainless steel ball bearings for improved performance. The dual spring based carbide seal system, guarantees long-lasting operation under tough conditions.



**DYCI Swivel**

Part No. 55.253

**DYDI Swivel (7300 psi)**

Part No. 55.263

**Low pressure option**

This allows for the application of chemicals at low pressure, continuously adjustable through a regulating screw.



**FL-CR 520**

**FL-CG 520**

| Name         | Part No. | ø   | Weight   | Swivel  | Rotor Arm    | HP-<br>Nozzles | HP-<br>Gun | Stainless<br>Steel<br>Caster |
|--------------|----------|-----|----------|---------|--------------|----------------|------------|------------------------------|
| FL-CG 520    | 80.770   | 21" | 22.7 lbs | 1x DYCI | 2x 1/8" NPTF | 2x 1503        | 1x         | —                            |
| FL-CR 520    | 80.771   | 21" | 26.4 lbs | 1x DYDI | 2x 1/8" NPTF | 2x 1503        | 1x         | 4x ø2 1/4"                   |
| FL-CRz 520** | 80.776   | 21" | 30.0 lbs | 1x DYDI | 2x 1/8" NPTF | 2x 1503        | 1x         | 4x ø2 1/4"                   |
| FL-RY 520*   | 80.159   | 21" | 25.4 lbs | 1x DYDI | 2x 1/8" NPTF | —              | —          | 4x ø2 1/4"                   |
| FL-RY 750*   | 80.359   | 30" | 29.8 lbs | 1x DYDI | 3x 1/8" NPTF | —              | —          | 4x ø2 1/4"                   |
| FL-CR 750    | 80.772   | 30" | 34.1 lbs | 1x DYDI | 3x 1/8" NPTF | 3x 1503        | 1x         | 4x ø2 1/4"                   |

\* Pressure: 7300 psi / Inlet 1/4" NPTM, \*\* with low pressure package!

**Accessories**

| Name                 | Part No. | LP-Valve | LP-Hose | Assembly kit | Weight |
|----------------------|----------|----------|---------|--------------|--------|
| Low pressure package | 80.9053  | 1x       | 1x      | 1x           | 1.5 kg |



- ✓ Available in various designs
- ✓ Multi-functional, suitable for any surfaces
- ✓ Ready to install



### FEATURES

#### Rotor Arms

Can withstand up to 4000 psi, and are precision welded and balanced.

- 2w2 (2 Arms / 2 Nozzles)** Part No. 82.621 (ø5")
- 2w2 (2 Arms / 2 Nozzles)** Part No. 82.623 (ø10")
- 2w2 (2 Arms / 2 Nozzles)** Part No. 82.625 (ø16")



#### Proven Innovation

Developed by Mosmatic and in service for years, the toggle swivel has proven itself. The toggle joint feature allows effortless cleaning of walls and angled surfaces. The movement of the joint is adjustable for fatigue free cleaning.



#### KDYF Toggle Swivel

Part No. 58.908

#### Quality Swivel

High rpm stainless steel swivel, features reinforced self-lubricated stainless steel ball bearings for improved performance. The dual spring based carbide seal system, guarantees long lasting operation under tough conditions.



#### DYF Swivel

Part No. 58.000

#### Stainless Steel Caster

Heavy duty ø2 1/2" casters with custom mounting brackets ensure easy maneuvering and longevity.



#### Stainless Steel Caster

Part No. 80.943

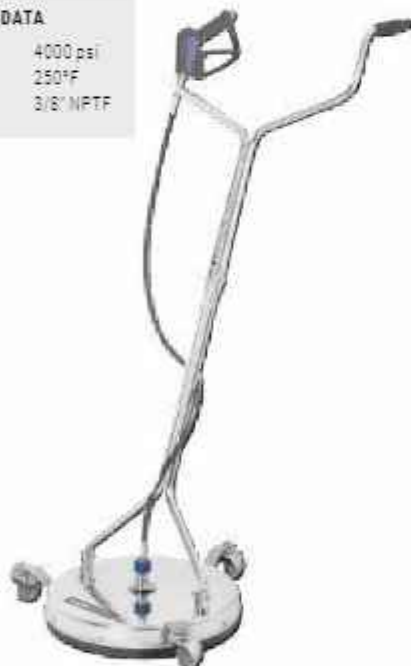

FL-ERG 410



FL-ER 410

FL-EG 410

FL-ER 300

FL-EG 300

FL-EG 200

FL-EB 200

| Name       | Part No. | ø   | Weight   | Swivel  | Rotor Arm    | HP-<br>Nozzles | HP-<br>Gun | Wand/<br>Fork | Stainless<br>Steel Caster |
|------------|----------|-----|----------|---------|--------------|----------------|------------|---------------|---------------------------|
| FL-EB 200  | 78.250   | 8"  | 4.2 lbs  | 1x DYF  | 2x 1/8" NPTF | 2x 1503        | 1x         | ---           | ---                       |
| FL-EG 200  | 78.260   | 8"  | 3.3 lbs  | 1x KDYF | 2x 1/8" NPTF | 2x 1503        | 1x *       | Wand *        | ---                       |
| FL-EG 300  | 78.262   | 12" | 7.1 lbs  | 1x KDYF | 2x 1/8" NPTF | 2x 1503        | 1x *       | Wand *        | ---                       |
| FL-ER 300  | 78.272   | 12" | 9.5 lbs  | 1x KDYF | 2x 1/8" NPTF | 2x 1503        | 1x *       | Wand *        | 3x ø2 1/2"                |
| FL-EG 410  | 78.264   | 16" | 10.4 lbs | 1x KDYF | 2x 1/8" NPTF | 2x 1503        | 1x         | Wand          | ---                       |
| FL-ER 410  | 78.274   | 16" | 13.0 lbs | 1x KDYF | 2x 1/8" NPTF | 2x 1503        | 1x         | Wand          | 3x ø2 1/2"                |
| FL-ERG 410 | 78.279   | 16" | 18.3 lbs | 1x DYF  | 2x 1/8" NPTF | 2x 1503        | 1x         | Fork          | 3x ø2 1/2"                |



- ✓ Steam cleaned surfaces are flash dry
- ✓ Huge time saving
- ✓ Mosmatic quality swivel and rotor arm
- ✓ Adjustable drive and impact angle
- ✓ Temperature up to 350°F



### TECHNICAL DATA

|                   |           |
|-------------------|-----------|
| Pressure          | 300 psi   |
| Temperature       | 350°F     |
| Inlet             | 3/8" NPTM |
| Throughput medium | Steam     |

Works best with  
a 10kW steam machine.

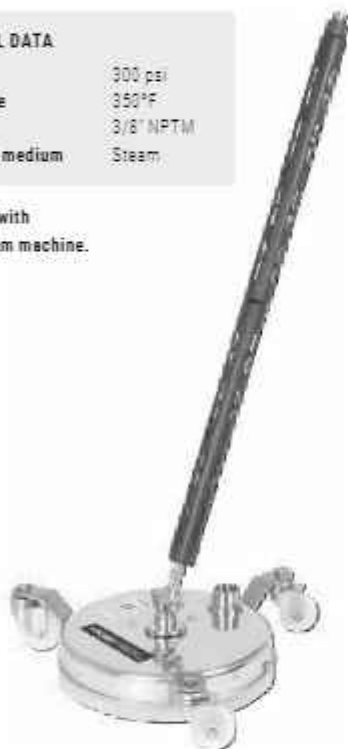

**STM 300**



**STM 200**

## FEATURES

### Quality Swivel

The heart of a Mosmatic Steaminator is the swivel which is reinforced with self-lubricating, stainless steel ball bearings and a high temperature seal system. The DXF is specially designed for high revolutions to ensure long lasting durability. Both STM models come with our patented swivel. This swivel is perfect for cleaning many surfaces including walls while remaining flush to the surface.



### KDXFS Toggle Swivel for ø8"/ø12"

Part No. 88.905

### DXFS Swivel for ø8"

Part No. 88.904

### Rotor arm

The adjustable rotor arm allows the user to change the spray angle and the impact on the surface being cleaned.



### 2x3 (2 Arms / 2 Nozzles)

Part No. 88.995 (ø6")

Part No. 88.996 (ø10")

### Recovery System

The double walled housing and reclaim port allow you to attach your vacuum system to the unit. This decreases drying time and allows the user to recover and recycle the used liquid and residue, making it an eco-friendly alternative to cleaning with just one wand.

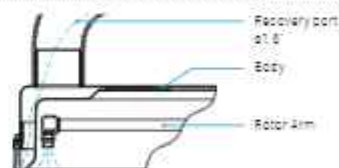

### Polyamide Casters

The casters allow free movement in any direction while keeping the nozzles at an even distance from the cleaning surface. Fatigue is therefore reduced while saving you time and energy.



### Polyamide Caster

Part No. 80.986 (for ø8" and ø12")

### Splash protection

The plastic rim guard prevents over spray and flying debris. It is extremely effective thanks to the wavy design.



### Steam nozzle



| Part No. | IN        | Angle | ø   |
|----------|-----------|-------|-----|
| 18.50290 | 1/8" NPTM | 50°   | 2.9 |

| Name    | Part No. | ø   | Swivel   | Rotor arm    | Nozzles     | PA Casters | Weight  |
|---------|----------|-----|----------|--------------|-------------|------------|---------|
| STM 200 | 78.094   | 8"  | 1x DXFS  | 2x 1/8" NPTF | 2x 18.50290 | 3x ø24"    | 5.7 lbs |
| STM 200 | 78.099   | 8"  | 1x KDXFS | 2x 1/8" NPTF | 2x 18.50290 | 3x ø24"    | 6.2 lbs |
| STM 300 | 78.194   | 12" | 1x KDXFS | 2x 1/8" NPTF | 2x 18.50290 | 3x ø24"    | 8.8 lbs |

Steam gun not included.

# HURRICANE FLIP

- ✓ 2-in-1
- ✓ Versatile in use
- ✓ High precision rotor arm/rotor unit
- ✓ High quality swivel or toggle swivel
- ✓ Easy flip function



The Mosmatic Hurricane Flip can be used as surface cleaner and underbody wash, all in one unit. Thanks to the low profile, the vehicle does not need to be lifted on a platform to be cleaned. The Hurricane Flip is time-saving, cost-efficient, and can be operated with cold and hot water.



### TECHNICAL DATA

Pressure 4000 psi  
 Temperature 250°F  
 Inlet 3/8" NPTF

### FEATURES

#### Flip function

Effortless turning of the wheels / 2-in-1 function. The Hurricane Flip can be converted from a floor cleaner to an undercarriage cleaner in just a few simple steps.

Part No. 80.9030 ø12" Part No. 80.9045 ø21"



### HURRICANE FLIP ø21" FEATURES

#### High quality swivel

DVF swivel with reinforced, self-lubricating stainless steel ball bearings and a carbide sealing system for high speed rotation.

Part No. 58.923



#### High precision rotor arm

The rotor arm, which is manufactured in an automated welding process is robust and balanced.

Part No. 82.942 ø18.5"



### HURRICANE FLIP ø12" FEATURES

#### High precision rotor unit

DVF swivel with reinforced, self-lubricating bearings made from stainless steel and a carbide sealing for high RPM. New rotor arm design with low profile for cleaning jobs with limited clearance.

Part No. 58.913



#### Toggle swivel

The proven toggle joint makes easy and effortless cleaning possible. Positioned on the side of the housing, this special design enables cleaning under the vehicle.

Part No. 42.906



#### HP-Coupling

The 1/4" quick coupler easily connects or disconnects the wand to the rotor unit for storage purposes or for use with other equipment.

Part No. 70.021 + 70.904



**Important: Do not use unprotected!**

### Hurricane Flip

| Name     | Part No. | ø   | min. Clearance | Weight   | Rotorarm     | HP-Nozzles | HP-Gun | Stainless Steel Caster |
|----------|----------|-----|----------------|----------|--------------|------------|--------|------------------------|
| HURF-300 | 78.607   | 12" | 4"             | 11.7 lbs | 2x 1/8" NPTF | 2x 1503    | 1x     | 3x ø2 1/2"             |
| HURF-520 | 80.616   | 21" | 5.7"           | 28.7 lbs | 2x 1/8" NPTF | 2x 1503    | 1x     | 3x ø2 1/4"             |

Other nozzle sizes please order separately.



- ✓ Ergonomical and versatile
- ✓ Easy to maneuver
- ✓ Ready to use
- ✓ Complete stainless steel



### TECHNICAL DATA

Pressure 4000 psi  
 Temperature 250°F  
 Inlet 3/8" NPTF

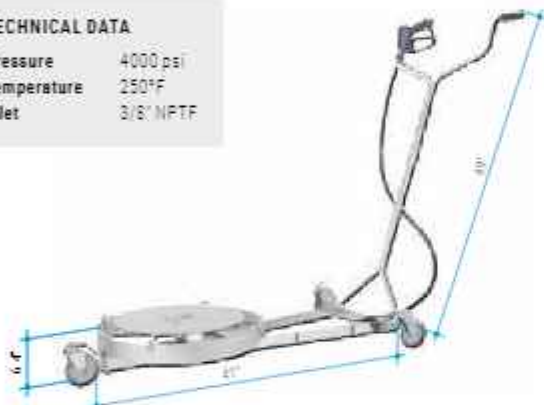

**HUR-520** 80.611

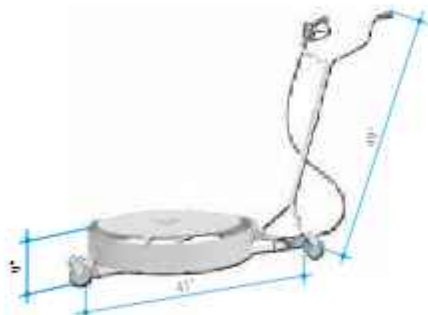

**HUR-750** 80.614

## FEATURES

### Stabilizer Nozzles

With the stabilizer nozzle, you can increase the distance and pressure impact to your surface. Standard on 80.613 and 80.614.



### HP-Nozzles

Standard HP, 15° nozzles are used to achieve the cleaning on the object. These nozzles are used on the models 80.611 and 80.612.



### Rotor Arms

Can withstand up to 4000 psi, are precision welded and balanced.



Part No. 82.991 ø19.5" Part No. 82.9014 ø27.5"

### Quality Swivel

High rpm stainless steel swivel features reinforced self-lubricated stainless steel ball bearings for improved performance. The dual spring based carbide seal system, guarantees long lasting operation under tough conditions.



Part No. 58.553

## Hurricane

| Name    | Part No. | ø   | min. Clearance | Weight | HP-Nozzles | HP-Gun | Caster/Wheels |
|---------|----------|-----|----------------|--------|------------|--------|---------------|
| HUR-520 | 80.611   | 21" | 6.5"           | 33 lbs | 2x 1303    | 1x     | 3x ø4"        |
| HUR-750 | 80.612   | 30" | 6.5"           | 42 lbs | 3x 1303    | 1x     | 3x ø4"        |
| HUR-520 | 80.613   | 21" | 9.1"           | 37 lbs | 2x 0003 EG | 1x     | 3x ø4"        |
| HUR-750 | 80.614   | 30" | 9.1"           | 45 lbs | 3x 0003 EG | 1x     | 3x ø4"        |

Other nozzles sizes please order separately.



### Accessories

| Name                 | Part No. | Nozzles | HP-Gun | Upper Fork | LP-Hose | Weight  |
|----------------------|----------|---------|--------|------------|---------|---------|
| Low pressure package | 80.9011  | ---     | 1x     | 1x         | 1x      | 8.4 lbs |

\* Nozzles not included, please order separately.

**Important: Do not use unprotected!**



- ✓ 6 different cleaning angles
- ✓ Ergonomical and versatile
- ✓ Easy to maneuver
- ✓ Ready to use
- ✓ Complete stainless steel



With the Hurricane Pro model, you are not only able to clean underneath vehicles, you also have the ability to pivot the spray deck which allows for multiple cleaning angles. The adjustable angles allow "all-around" cleaning of construction equipment, fleet vehicles, boats or agricultural machines using just one model undercarriage cleaner. The Hurricane Series is time-saving and cost efficient. Use this new cleaning tool from Mosmatic with either hot or cold pressure washer.



### TECHNICAL DATA

Pressure 4000 psi  
 Temperature 250°F  
 Inlet 3/8" NPTF



**HURp-520** 80.617



**HURpz-520** 80.618



### FEATURES

#### Cleaning angles

The Hurricane Pro cleaner offers the ability to pivot the spray deck which allows for multiple cleaning angles. Deck adjustment from 0° to maximum 90°.

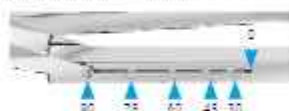

#### Large casters

Three large casters make your cleaning job easier with full range of motion, allowing you to maneuver even on rough surfaces.



#### Stabilizer Nozzles

With the stabilizer nozzle, you can increase the distance and pressure impact to your surface. Standard on 80.617 and 80.618.



#### Rotor Arms

Can withstand up to 4000 psi, are precision welded and balanced.



Part No. 82.891 ø18.5" Part No. 82.9014 ø27.5"

#### Quality Swivel

High rpm stainless steel swivel features reinforced self lubricated stainless steel ball bearings for improved performance. The dual spring based carbide seal system, guarantees long lasting operation under tough conditions.



Part No. 58.553

#### Low pressure option

This provides the ability to apply chemicals at low pressure, for example, salt neutralization, oil removal or other chemical applications.



### Hurricane Pro

| Name      | Part No. | ø   | min. Clearance | Weight | HP-Nozzles | LP-Nozzles | HP-Gun | Casters |
|-----------|----------|-----|----------------|--------|------------|------------|--------|---------|
| HURp-520  | 80.617   | 21" | 8.9"           | 68 lbs | 2x 0003 EG | —          | 1x     | 3x ø6"  |
| HURpz-520 | 80.618   | 21" | 8.9"           | 75 lbs | 2x 0003 EG | 4x 1508    | 2x     | 3x ø6"  |

Other nozzle sizes please order separately.

#### Accessories

| Name                 | Part No. | Nozzles | HP-Gun | Upper Fork | LP-Hose | Weight  |
|----------------------|----------|---------|--------|------------|---------|---------|
| Low pressure package | 80.9011  | —"      | 1x     | 1x         | 1x      | 8.4 lbs |

\* Nozzles not included, please order separately.

**Important: Do not use unprotected!**

- ✓ Height and width adjustable
- ✓ Quad bearing swivel
- ✓ For professional roof cleaners



## FEATURES

### Height and width adjustable

The DR-520. Width is adjustable up to 3.54' and 1.31' in height. Will work for most roof designs adding safety and stability.



### Safety Eye

Allows you to easily secure the roof cleaner with a safety rope or cable.



### Pressure Gauge

Use the pressure gauge to monitor your cleaning pressure. This allows you to ensure proper pressure when cleaning a variety of roofing materials.

Part No. 903.032



### Ball Valve

Makes it easy and convenient to turn off the flow to the unit.

Part No. 90.066



### Rotor Arms

Can withstand up to 4000 psi or 7300 psi, are precision welded and balanced.



**2ow2 (2 Arms / 2 Nozzles / 4000 psi)**    **2ow2 (2 Arms / 2 Nozzles / 7300 psi)**

Part No. 82.942 1/8" (p18.5")

Part No. 82.941 1/4" (p18.5")

Part No. 82.975 1/4" (p18.5")

### Quality Swivel

High rpm stainless steel swivel features 4x reinforced self lubricated stainless steel ball bearings for improved performance. The dual spring based carbide seal system, guarantees long lasting operation under tough conditions.



**DYU Swivel (7300 psi)**

Part No. 59.916

**DYT Swivel (4000 psi)**

Part No. 59.907

## TECHNICAL DATA

|             |                 |
|-------------|-----------------|
| Pressure    | 4000 / 7300 psi |
| Temperature | 250°F           |
| Inlet       | 3/8" NPTF       |
|             | Ø1/4" F         |



**DR-520**

### Height adjusters long

Add an additional 2.4" height if needed, e.g. for corrugated roofs.

Part No. 904.351 (1 pos)  
Requires 4 pieces



### Pedal switch

For additional safety, Mosmatic recommends you turn your flow on and off using the optional pedal switch.

Part No. 80.987



| Name    | Part No. | ø   | Width       | Height  | Weight   | Rotor Arm    | HP-Nozzles |
|---------|----------|-----|-------------|---------|----------|--------------|------------|
| DR-520  | 80.658   | 21" | 21.6"-25.2" | 7.7"-9" | 31.9 lbs | 2x 1/8" NPTF | ---        |
| DR-520* | 80.662   | 21" | 21.6"-25.2" | 7.7"-9" | 31.9 lbs | 2x 1/8" NPTF | ---        |

\* Pressure: 7300 psi / Inlet Ø1/4" F



- ✓ Cost effective upgrade
- ✓ Easy to assemble

For those of you who do not currently own a Mosmatic and wish to upgrade your equipment. The Upgrade Kit will allow you to replace the important "working parts" of your surface cleaner with Mosmatic high quality components.



### TECHNICAL DATA

Pressure 5000 psi  
 Temperature 250°F  
 Inlet 3/8" NPTF

### FEATURES

#### Adapter plate

The universal mounting plate allows you to mount the Mosmatic swivel on your existing housing. The plate has pre-drilled holes and adapts to most other brands of surface cleaners.



#### Extension fitting

The adapter is used to reduce the distance of the nozzle to the cleaning surface. Depending on the existing housing height, it may be necessary to use this optional adapter. The adapter will reduce the distance by 0.37".



#### Mounting bolts

Includes 3 bolts for fastening the adapter plate to swivel.



### Upgrade Kit

| Name | Part No. | Includes  |
|------|----------|---|
| FL-Z | 55.903   | ➊ Adapter plate, ➋ Mounting bolts, ➌ Distance-adapter |

### FEATURES

#### Quality Swivel

High rpm stainless steel swivel features reinforced self-lubricated stainless steel ball bearings for improved performance. The dual spring based carbide seal system, guarantees long-lasting operation under tough conditions.



#### Rotor Arms

Can withstand up to 5000 psi, are precision welded and balanced.



### ALL-IN-ONE PACKAGES

Includes the above Upgrade Kit 55.903, a swivel and rotor arm of your choice.

| Name | Part No. | Includes  |
|------|----------|---|
| FL-Z | 55.913   | ➊ DYC Swivel 3/8" NPTF, ➋ Adapter plate, ➌ Mounting bolts, ➍ Distance-adapter, ➎ Rotor Arm TKA 2w2¼" a12" |
| FL-Z | 55.914   | ➊ DYC Swivel 3/8" NPTF, ➋ Adapter plate, ➌ Mounting bolts, ➍ Distance-adapter, ➎ Rotor Arm TKA 2w2¼" a15" |
| FL-Z | 55.915   | ➊ DYC Swivel 3/8" NPTF, ➋ Adapter plate, ➌ Mounting bolts, ➍ Distance-adapter, ➎ Rotor Arm TKA 3w3¼" a18" |

Nozzles not included.





- ✓ Easy installation
- ✓ Self rotating and stainless steel
- ✓ Adjustable and non adjustable versions
- ✓ Protection plate available
- ✓ Maintenance free



Clean vent hoods, trash chutes, pipes, totes, manholes and most containers. This self-rotating unit is completely maintenance free. The rotating head spins within the protective cage directing the high pressure spray to your surface. The installation is simple and fast.



(81.526)

\* Nozzles not included.

**Important:**  
Do not use unprotected!

### TYR \*adjustable\*

The adjustable arms allow different spray angles. Perfect for horizontal ducts and tanks.

| warm water |          | cold water |          | ø   | IN        | Height | Weight  |
|------------|----------|------------|----------|-----|-----------|--------|---------|
| TYR-2s     | TYR-3s   | TRR-2s     | TRR-3s   |     |           |        |         |
| Part No.   | Part No. | Part No.   | Part No. |     |           |        |         |
| 81.505     | 81.705   | 85.505     | 85.705   | 3"  | 1/4" NPTF | 2.4"   | 1.1 lbs |
| 81.506     | 81.706   | 85.506     | 85.706   | 3"  | 3/8" NPTF | 2.4"   | 1.1 lbs |
| 81.525     | 81.725   | 85.525     | 85.725   | 6"  | 1/4" NPTF | 2.8"   | 2.2 lbs |
| 81.526     | 81.726   | 85.526     | 85.726   | 6"  | 3/8" NPTF | 2.8"   | 2.2 lbs |
| 81.555     | 81.755   | 85.555     | 85.755   | 12" | 1/4" NPTF | 2.8"   | 2.8 lbs |
| 81.556     | 81.756   | 85.556     | 85.756   | 12" | 3/8" NPTF | 2.8"   | 2.8 lbs |
| 81.565     | 81.765   | 85.565     | 85.765   | 16" | 1/4" NPTF | 2.8"   | 3.3 lbs |
| 81.566     | 81.766   | 85.566     | 85.766   | 16" | 3/8" NPTF | 2.8"   | 3.3 lbs |
| 81.575     | 81.775   | 85.575     | 85.775   | 20" | 1/4" NPTF | 2.8"   | 3.5 lbs |
| 81.576     | 81.776   | 85.576     | 85.776   | 20" | 3/8" NPTF | 2.8"   | 3.5 lbs |
| 81.585     | 81.785   | 85.585     | 85.785   | 24" | 1/4" NPTF | 2.8"   | 3.9 lbs |
| 81.586     | 81.786   | 85.586     | 85.786   | 24" | 3/8" NPTF | 2.8"   | 3.9 lbs |



(81.426)

\* Nozzles not included.

**Important:**  
Do not use unprotected!

### TYR \*fixed\*

The non adjustable arms with fixed spray angle is perfect for vertical chutes.

| warm water |          | cold water |          | ø   | IN        | Height | Weight  |
|------------|----------|------------|----------|-----|-----------|--------|---------|
| TYR-2f     | TYR-3f   | TRR-2f     | TRR-3f   |     |           |        |         |
| Part No.   | Part No. | Part No.   | Part No. |     |           |        |         |
| 81.405     | 81.605   | 85.405     | 85.605   | 3"  | 1/4" NPTF | 2.4"   | 1.1 lbs |
| 81.406     | 81.606   | 85.406     | 85.606   | 3"  | 3/8" NPTF | 2.4"   | 1.1 lbs |
| 81.425     | 81.625   | 85.425     | 85.625   | 6"  | 1/4" NPTF | 2.8"   | 2.2 lbs |
| 81.426     | 81.626   | 85.426     | 85.626   | 6"  | 3/8" NPTF | 2.8"   | 2.2 lbs |
| 81.455     | 81.655   | 85.455     | 85.655   | 12" | 1/4" NPTF | 2.8"   | 2.8 lbs |
| 81.456     | 81.656   | 85.456     | 85.656   | 12" | 3/8" NPTF | 2.8"   | 2.8 lbs |
| 81.465     | 81.665   | 85.465     | 85.665   | 16" | 1/4" NPTF | 2.8"   | 3.3 lbs |
| 81.466     | 81.666   | 85.466     | 85.666   | 16" | 3/8" NPTF | 2.8"   | 3.3 lbs |
| 81.475     | 81.675   | 85.475     | 85.675   | 20" | 1/4" NPTF | 2.8"   | 3.5 lbs |
| 81.476     | 81.676   | 85.476     | 85.676   | 20" | 3/8" NPTF | 2.8"   | 3.5 lbs |
| 81.485     | 81.685   | 85.485     | 85.685   | 24" | 1/4" NPTF | 2.8"   | 3.9 lbs |
| 81.486     | 81.686   | 85.486     | 85.686   | 24" | 3/8" NPTF | 2.8"   | 3.9 lbs |

#### TECHNICAL DATA

|             |                             |            |                            |
|-------------|-----------------------------|------------|----------------------------|
| Pressure    | 4000 psi                    | Nozzles    | 2f/2s for 2x 1/8" Nozzles* |
| Temperature | TYR 250°F / TRR 90°F        |            | 3f/3s for 3x 1/8" Nozzles* |
| Inlet       | see chart                   | Throughput | ph 3-12                    |
| Body        | stainless steel             |            |                            |
| RPM         | TYR 2000 rpm / TRR 1000 rpm |            |                            |

## TRL WAND

- ✓ Complete solution
- ✓ Delivered ready to install
- ✓ Ergonomic design

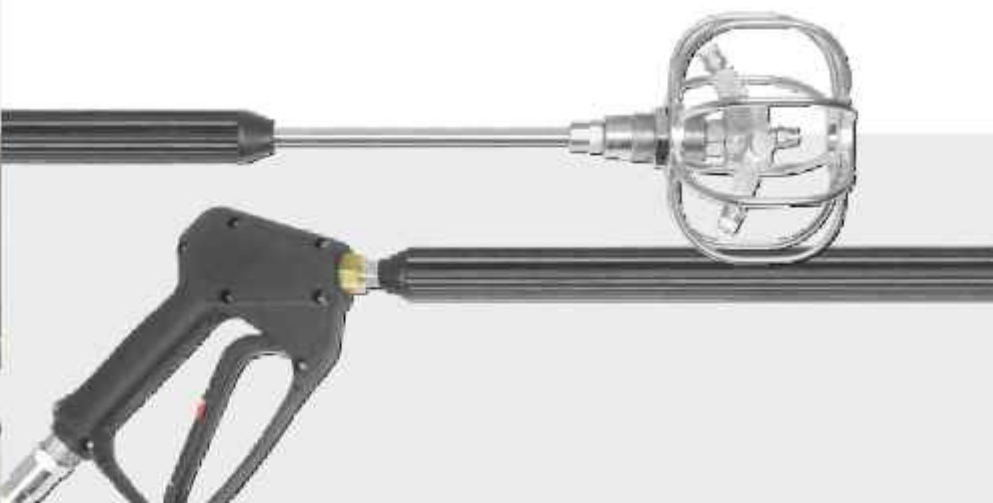

### TECHNICAL DATA

|             |           |
|-------------|-----------|
| Pressure    | 4000 psi  |
| Temperature | 250°F     |
| Inlet       | 3/8" NPTF |
| Throughput  | ph 3 - 12 |

**Important: Do not use unprotected!**

This complete cleaning wand with rotating spinner head was designed to clean tanks, trash cans, plastic containers and portable toilets. There are three nozzles included with the spinner head. Two are adjustable nozzles and are located on the side and one on the end of the unit. Side cleaning nozzles also prevent forward blowback.



### TRL Wand

with swivel

| Part No. | IN        | Swivel | Length | lb | HP/Nozzle | Weight  |
|----------|-----------|--------|--------|----|-----------|---------|
| 81.925   | 3/8" NPTF | yes    | 69"    | 6" | 3x 0502   | 5.5 lbs |

## HP SPECIAL WAND

- ✓ HP-Gun with low trigger force and swivel
- ✓ Variable handle
- ✓ With different nozzles available



### TECHNICAL DATA

|               |           |
|---------------|-----------|
| Pressure      | 4000 psi  |
| Temperature   | 250°F     |
| Nominal width | 1/4"      |
| Throughput    | ph 3 - 12 |

**Important: Do not use unprotected!**

The Mosmatic standard wands made of high quality stainless steel are now available with special nozzles. It can be chosen between Wand with Turbo Nozzle, with Chewing gum remover nozzle or with the Standard Mosmatic Nozzle. The solid construction and the unique workmanship ensure longevity and value.



### HP Rotor-Wand

| Part No. | IN        | Total length | Swivel | Nozzle | Weight  |
|----------|-----------|--------------|--------|--------|---------|
| 24.919   | 3/8" NPTF | 52"          | yes    | 14.915 | 4.6 lbs |



### HP Gum-Wand

| Part No. | IN        | Total length | Swivel | Nozzle | Weight  |
|----------|-----------|--------------|--------|--------|---------|
| 24.929   | 3/8" NPTF | 52"          | yes    | 29.119 | 4.4 lbs |



### HP Standard-Wand

| Part No. | IN        | Total length | Swivel | Nozzle | Weight  |
|----------|-----------|--------------|--------|--------|---------|
| 24.939   | 3/8" NPTF | 49"          | yes    | ---    | 3.3 lbs |
| 24.949*  | 3/8" NPTF | 49"          | yes    | ---    | 3.3 lbs |



# MANHOLE CLEANER

- ✓ With protection plate
- ✓ Optimal cleaning of vertical main
- ✓ Easy to use



The Mosmatic Manhole Cleaner is ideal for the restoration, cleaning and service of manholes, liftstations and other long vertical drops. Easy to use self rotating equipment made for higher flow rates. Stainless Steel protection plate included. Choose from a variety of sizes.



### TECHNICAL DATA

Pressure 2500 psi  
 Temperature 250°F  
 Inlet 1/2" NPTF (TXS-2f)  
 1" NPTF (TXS-4f)  
 Body stainless steel  
 Nozzles\* for 2x 1/8" (TXS-2f)  
 for 4x 1/8" (TXS-4f)  
 Throughput pH 3 - 12

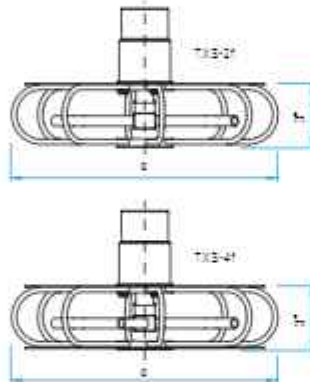

### TXS-2f with protective plate

| Part No. | ø   | Weight   |
|----------|-----|----------|
| 81.037   | 12" | 8.1 lbs  |
| 81.047   | 16" | 9.7 lbs  |
| 81.057   | 20" | 11.7 lbs |
| 81.067   | 24" | 14.1 lbs |
| 81.087   | 32" | 14.3 lbs |

### TXS-4f with double protective plate

| Part No. | ø   | Weight   |
|----------|-----|----------|
| 81.923   | 20" | 13.4 lbs |
| 81.928   | 16" | 11.9 lbs |

\* Nozzles not included

**Important: Do not use unprotected!**

# SILO CLEANER

- ✓ Adjusts to your application
- ✓ Equipped with stabilizer nozzles
- ✓ Completely maintenance-free



Mosmatic has a solution for cleaning Silo's and other large diameter vertical drops. The extendable arms with rollers help guide and maintain a close surface cleaning impact. Simply attach a suspension cable to the eyelets and use your winch to raise and lower the Silo Cleaner. Stabilizer nozzles increase the cleaning distance and impact and maintain a more concentrated spray pattern. Stainless steel construction and maintenance free design help to ensure long life and reliability.



### Silo-R

| Part No. | Length/Width | Height | Rotor Arm | Nozzles    | Wheels | Weight |
|----------|--------------|--------|-----------|------------|--------|--------|
| 81.095   | 6'6"-11'6"   | 8"     | 82.9036   | 2x 0005 EG | 4x ø4" | 55 lbs |

### FEATURES

#### Variable Lengths & Foldable

The length of the rotating arm is easily adjusted from 80" to 140". Folding the Silo Cleaner allows for a tight fit into the Silo loading port.

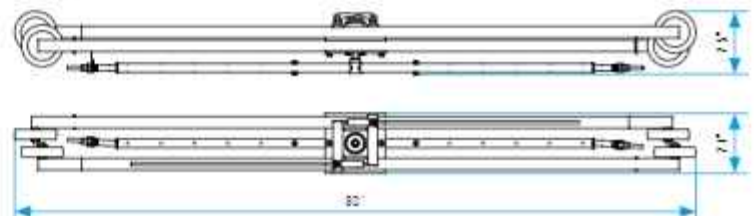

### TECHNICAL DATA

Pressure 2500 psi  
 Temperature 250°F  
 Inlet 1/2" NPTF



- ✓ Complete hydro-driven head for vehicle washes
- ✓ Long range impact stabilizer nozzles
- ✓ Stainless steel construction
- ✓ High and low volume versions available



This rotary-head equipped with four stabilizer nozzles makes it possible to clean all kinds of surfaces from a further distance without pressure loss. Air injection nozzles expand and contain the water flow allowing longer distance of travel and provide that "punch impact" needed for heavy debris cleaning.

Common applications:  
Train, Bus, Truck, Construction,  
Military Vehicles and Container Wash Systems.

**Important:**  
Do not use rotor arms unprotected!

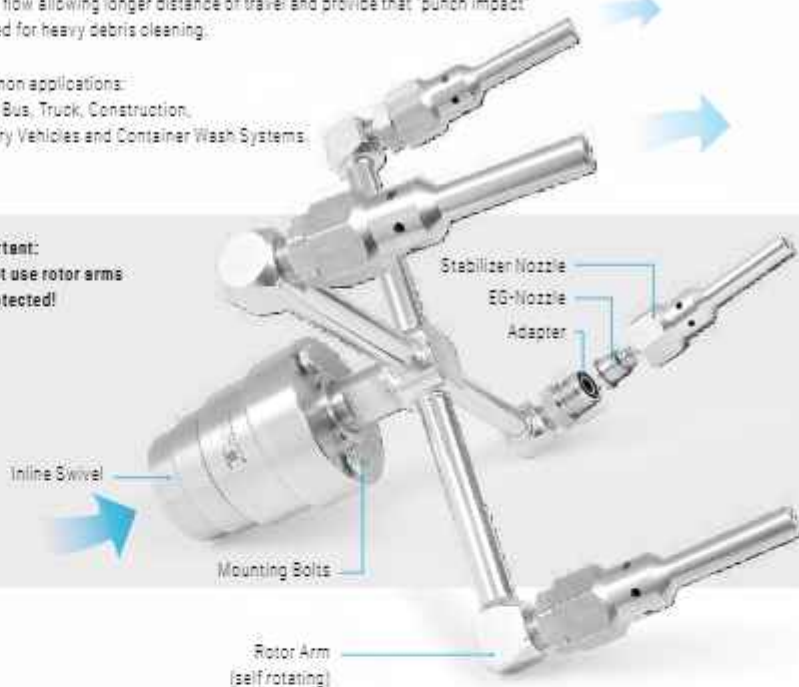

### TECHNICAL DATA

Pressure 2500 psi  
Temperature 250°F  
Inlet see chart.

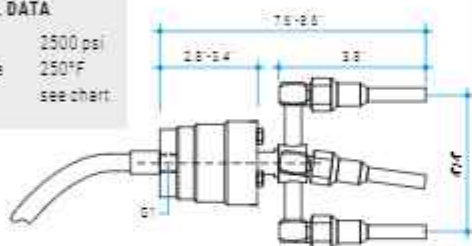

### Complete Spider <sup>A</sup>

| Part No. | G1 (F)    | NW | Swivel         | 25° Rotor Arm | Stabilizer Nozzles | Insert Nozzle | Bolts   |
|----------|-----------|----|----------------|---------------|--------------------|---------------|---------|
| 81.933   | 3/8" NPTF | 9  | DXTIs (39.663) | 4w4 (82.954)  | 4x 14.901          | —*            | 3 Units |
| 81.934   | 1/2" NPTF | 12 | DXTIs (39.865) | 4w4 (82.9084) | 4x 14.901          | —*            | 3 Units |
| 81.935   | 3/4" NPTF | 12 | DXTIs (39.907) | 4w4 (82.9084) | 4x 14.901          | —*            | 3 Units |
| 81.936   | 1" NPTF   | 12 | DXTIs (39.905) | 4w4 (82.9084) | 4x 14.901          | —*            | 3 Units |

\* Requires 4x EG-Nozzles, according to your pump specifications

### TECHNICAL DATA

Pressure DYT 4000 psi  
DXTI 2500 psi  
Temperature 250°F  
Inlet see chart

Design your personal Spider:  
Choose the swivel, rotor arm and  
the nozzles to suit your needs.  
Follow the numbers 1-4.

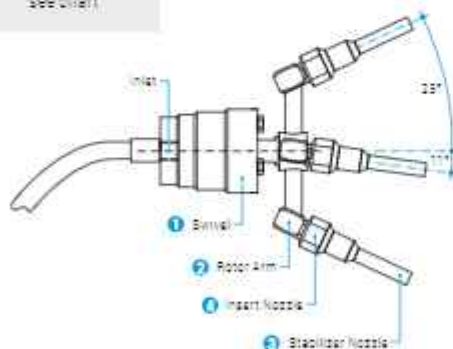

### Individual 3/8" Spider <sup>B</sup>

| 1 Swivel (Inlet)       | 2 Rotor Arm (Diameter)               | 3 Stabilizer Nozzle | 4 Insert Nozzle |
|------------------------|--------------------------------------|---------------------|-----------------|
| 39.663 DYT (3/8" NPTF) | 82.9110 TKA 2w2 1/4" 11°/25° (4')    | 14.901              | 0002 EG         |
|                        | 82.9111 TKA 2w2 1/4" 11°/25° (6')    | 14.939              | 0003 EG         |
|                        | 82.9112 TKA 2w2 1/4" 11°/25° (8')    |                     | 0004 EG         |
|                        | 82.9113 TKA 4w4 1/4" 11°/25° (4'/4') |                     | 0005 EG         |
|                        | 82.9114 TKA 4w4 1/4" 11°/25° (6'/6') |                     | 0006 EG         |
|                        | 82.9115 TKA 4w4 1/4" 11°/25° (8'/8') |                     | 0007 EG         |
|                        |                                      |                     | 0008 EG         |
|                        |                                      |                     | 0009 EG         |

### Individual 1/2" Spider

| 1 Swivel (Inlet)        | 2 Rotor Arm (Diameter)               | 3 Stabilizer Nozzle | 4 Insert Nozzle |
|-------------------------|--------------------------------------|---------------------|-----------------|
| 39.865 DXTI (1/2" NPTF) | 82.9120 TKA 2w2 1/4" 11°/25° (4')    | 14.901              | 0010 EG         |
| 39.907 DXTI (3/4" NPTF) | 82.9121 TKA 2w2 1/4" 11°/25° (6')    | 14.939              | 0011 EG         |
| 39.905 DXTI (1" NPTF)   | 82.9122 TKA 2w2 1/4" 11°/25° (8')    |                     | 0012 EG         |
|                         | 82.9123 TKA 4w4 1/4" 11°/25° (4'/4') |                     | 0014 EG         |
|                         | 82.9124 TKA 4w4 1/4" 11°/25° (6'/6') |                     | 0018 EG         |
|                         | 82.9125 TKA 4w4 1/4" 11°/25° (8'/8') |                     | 0020 EG         |

## FEATURES

#### Quality Swivel

High rpm stainless steel swivel features reinforced self-lubricated stainless steel ball bearings for improved performance.



#### Rotor Arms

Precision welded and balanced rotor arms offer smooth vibration-free rotation, giving longer life to your rotary union.



#### Stabilizer Nozzles

The Mosmatic stabilizer nozzles included with your Spider ensure the effectiveness of your cleaning by increasing the distance and impact of your spray.



Part No. 14.901 (1/4" NPTM) without insert nozzle

Part No. 14.939 (1/4" NPTM) without insert nozzle, short version



#### <sup>A</sup> Action diameter

| Distance | Cleaning surface |
|----------|------------------|
| 10'      | 13'              |
| 20'      | 22'              |
| 30'      | 31'              |
| 40'      | 40'              |

#### <sup>B</sup> Action diameter

| Distance | Cleaning surface |     |     |
|----------|------------------|-----|-----|
|          | ø4"              | ø6" | ø8" |
| 10'      | 17'              | 19' | 21' |
| 20'      | 26'              | 29' | 31' |
| 30'      | 37'              | 40' | 41' |
| 40'      | 47'              | 49' | 51' |

## SPIDER ADJUSTABLE

- ✓ Rotation speed controllable
- ✓ Spray angle adjustable
- ✓ Long range impact stabilizer nozzles
- ✓ Quadruple bearing system
- ✓ Suitable for high water volume
- ✓ Continuous NW 1/2"



Thanks to the infinitely adjustable 360° spray angle, the rotation speed of this cleaning head can be adjusted as required. The four stabilizer nozzles make it possible to clean all kinds of surfaces from a further distance without pressure loss. Air injection nozzles expand and contain the water flow allowing longer distance of travel and provide that "punch impact" needed for heavy debris cleaning.

Common applications:  
Train, Bus, Truck, Construction,  
Military Vehicles and Container Wash Systems.

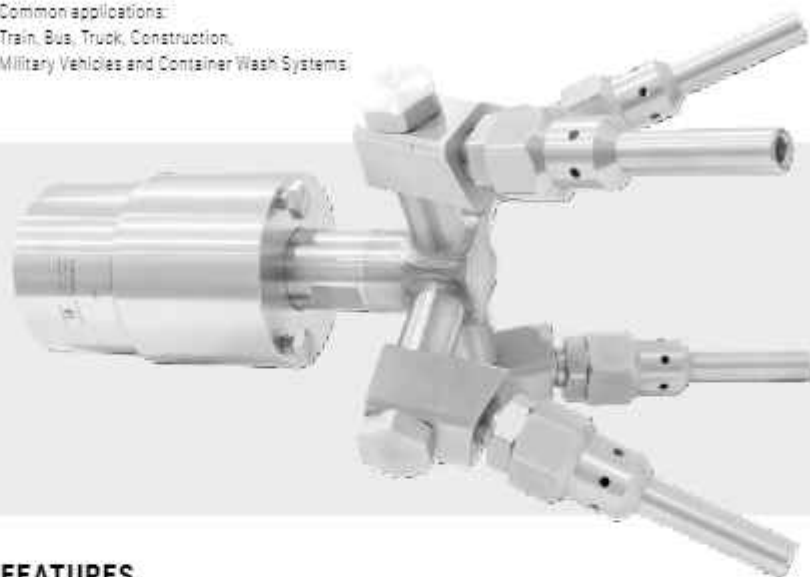

### TECHNICAL DATA

|             |          |
|-------------|----------|
| Pressure    | 2500 psi |
| Temperature | 250°F    |
| Inlet       | 1" NPTF  |

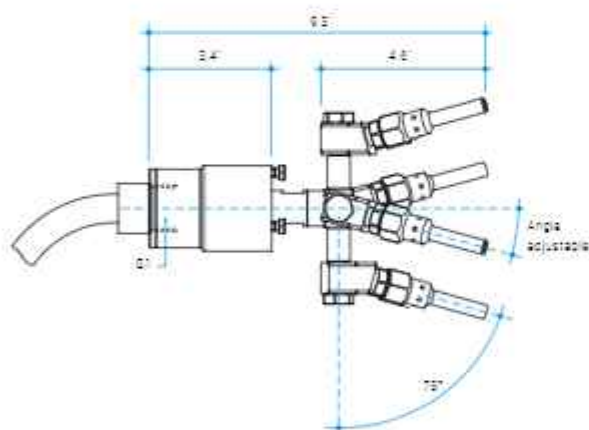

## FEATURES

### Quality Swivel

High rpm stainless steel swivel, features reinforced self-lubricated stainless steel ball bearings for improved performance. The dual spring based carbon seal system, guarantees long lasting operation under tough conditions.



### Adjustable Rotor Arm

The desired spray angle can be set in just a few steps thanks to the infinitely adjustable nozzle holder. Precision welded and balanced rotor arms offer smooth vibration free rotation, giving longer life to your swivel.



### Stabilizer Nozzles

The Mosmatic stabilizer nozzles included with your Spider ensure the effectiveness of your cleaning by increasing the distance and impact of your spray.



Part No: 14.933 (1/4" NPTM) without insert nozzle

## Spider adjustable

| Part No. | G1 (F)  | NW   | Swivel         | Rotor Arm    | Stabilizer Nozzles | Insert Nozzle | Bolts   |
|----------|---------|------|----------------|--------------|--------------------|---------------|---------|
| 81.944   | 1" NPTF | 1/2" | DXTis (39.905) | 4s4 (88.795) | 4x 14.933          | —             | 3 Units |

\* Requires 4x SS-nozzles, according to your pump specifications.

### Action diameter

| Distance | Cleaning surface |       |       |       |
|----------|------------------|-------|-------|-------|
|          | 10°              | 15°   | 20°   | 25°   |
| 10"      | 11.4"            | 13.0" | 15.0" | 17.3" |
| 20"      | 17.3"            | 20.9" | 23.6" | 27.6" |
| 30"      | 23.6"            | 28.4" | 33.0" | 38.2" |
| 40"      | 29.9"            | 35.8" | 42.2" | 48.8" |



# ROTOR ARMS

- ✓ Polished stainless steel
- ✓ Solid yet light construction
- ✓ Precision welded and balanced

High pressure rotor arms are constructed of stainless steel and come in a variety of configurations. Welded and balanced to eliminate dangerous vibrations and ensure smooth performance.

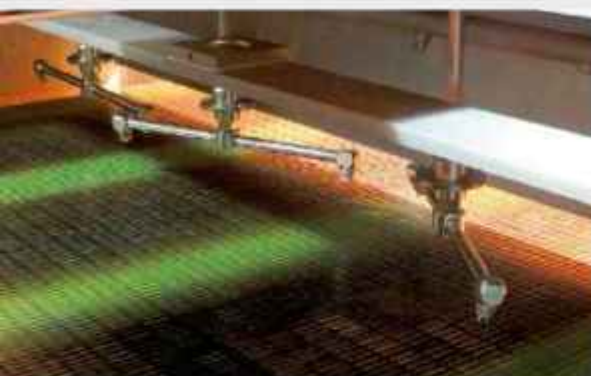

**Important:**  
Do not use rotor arms unprotected!

## TKA-2w2 (for two nozzles)    TKA-2w3 (for three nozzles)

| Part No.<br>1/4" Nozzles | Part No.<br>1/8" Nozzles | Part No.<br>1/4" Nozzles | Part No.<br>1/8" Nozzles | Diameter |
|--------------------------|--------------------------|--------------------------|--------------------------|----------|
| 82.705                   | 82.805                   | 82.720                   | 82.820                   | 4"       |
| 82.706                   | 82.806                   | 82.721                   | 82.821                   | 6"       |
| 82.707                   | 82.807                   | 82.722                   | 82.822                   | 8"       |
| 82.708                   | 82.808                   | 82.723                   | 82.823                   | 10"      |
| 82.709                   | 82.809                   | 82.724                   | 82.824                   | 12"      |
| 82.710                   | 82.810                   | 82.725                   | 82.825                   | 14"      |
| 82.711                   | 82.811                   | 82.726                   | 82.826                   | 16"      |
| 82.712                   | 82.812                   | 82.727                   | 82.827                   | 18"      |
| 82.791                   | 82.891                   | 82.792                   | 82.892                   | 18.5"    |
| 82.713                   | 82.813                   | 82.728                   | 82.828                   | 20"      |
| 82.714                   | 82.814                   | 82.729                   | 82.829                   | 22"      |
| 82.715                   | 82.815                   | 82.730                   | 82.830                   | 24"      |

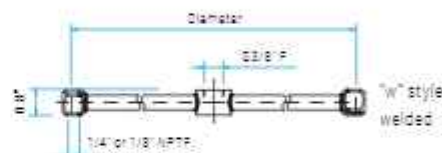

### Other styles

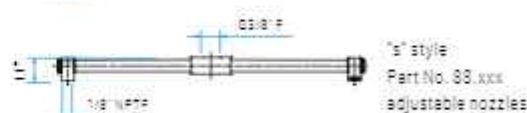
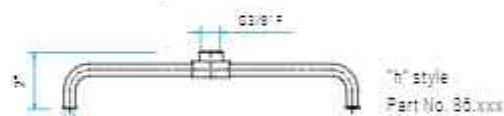

Matching swivel models are: DYT, DYCI, DYF, DYG, DYI.

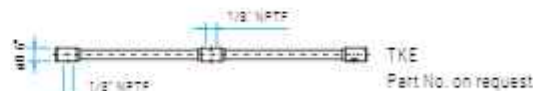

Matching swivel models are: DGL, DGS, DGF, DXL, DXG, DKF.

Mosmatic offers a variety of hardened stainless steel high pressure nozzles. All wash jet nozzles (MEG) are available in various sizes and spray angles. Standard nozzles are 1/8" & 1/4" NPTM, spray angles 0°, 5°, 15° & 25° and sizes 2 to 10.

Nozzles not included.

## TKA-3w3 (for three nozzles)    TKA-3w4 (for four nozzles)

| Part No.<br>1/4" Nozzles | Part No.<br>1/8" Nozzles | Part No.<br>1/4" Nozzles | Part No.<br>1/8" Nozzles | Diameter |
|--------------------------|--------------------------|--------------------------|--------------------------|----------|
| 82.765                   | 82.865                   | 82.780                   | 82.880                   | 4"       |
| 82.766                   | 82.866                   | 82.781                   | 82.881                   | 6"       |
| 82.767                   | 82.867                   | 82.782                   | 82.882                   | 8"       |
| 82.768                   | 82.868                   | 82.783                   | 82.883                   | 10"      |
| 82.769                   | 82.869                   | 82.784                   | 82.884                   | 12"      |
| 82.770                   | 82.870                   | 82.785                   | 82.885                   | 14"      |
| 82.771                   | 82.871                   | 82.786                   | 82.886                   | 16"      |
| 82.772                   | 82.872                   | 82.787                   | 82.887                   | 18"      |
| 82.793                   | 82.893                   | 82.794                   | 82.894                   | 18.5"    |
| 82.773                   | 82.873                   | 82.788                   | 82.888                   | 20"      |
| 82.774                   | 82.874                   | 82.789                   | 82.889                   | 22"      |
| 82.775                   | 82.875                   | 82.790                   | 82.890                   | 24"      |



## TKA-4w4 (for four nozzles)    TKA-4w5 (for five nozzles)

| Part No.<br>1/4" Nozzles | Part No.<br>1/8" Nozzles | Part No.<br>1/4" Nozzles | Part No.<br>1/8" Nozzles | Diameter  |
|--------------------------|--------------------------|--------------------------|--------------------------|-----------|
| 82.731                   | 82.831                   | 82.746                   | 82.846                   | 8"/8"     |
| 82.733                   | 82.833                   | 82.748                   | 82.848                   | 14"/8"    |
| 82.735                   | 82.835                   | 82.750                   | 82.850                   | 16"/6"    |
| 82.737                   | 82.837                   | 82.752                   | 82.852                   | 16"/10"   |
| 82.742                   | 82.842                   | 82.757                   | 82.857                   | 18.5"/14" |
| 82.743                   | 82.843                   | 82.758                   | 82.858                   | 20"/14"   |



### TECHNICAL DATA

|                          |  |
|--------------------------|--|
| <b>Pressure</b>          | 4000 psi (27.5 MPa)<br>also available as 7300 psi (50 MPa) |
| <b>Temperature</b>       | 250°F  |
| <b>Body &amp; pipe</b>   | stainless steel  |
| <b>IN</b>                | 3/8" F   |
| <b>OUT (for nozzles)</b> | 1/4" NPTF / 1/8" NPTF                                      |
| <b>Throughput medium</b> | pH 3-12  |

#### Legend

M = metric thrust, L = male, F = female, B = gas pipe thrust, R = gas pipe thrust conical, DV = quick connect, SW = profile ring fitting  
D = diameter, L = length, NW = nominal width, SW = insertion size, IN = male input, OUT = male output, RB = basic position



# NOZZLES



- ✓ 1/8", 1/4" and EG available
- ✓ Stainless steel
- ✓ Various spray angles

Mosmatic offers a variety of hardened stainless steel high pressure nozzles. All HP nozzles (Meg) are available in various sizes and spray angles. Standard nozzles are 1/8" & 1/4" NPT Male, spray angles 0°, 5°, 15° & 25° and sizes 2 through 10.

All EG nozzles, for use with stabilizer nozzles, have a 0° spray angle and are available from size 2 - 20.



HP



EG



Stabilizer Nozzle

## Your Part No.



## Nozzle recommendation (1 nozzle)

| Size | Orifice | Flow rate in GPM at: |         |         |         |          |          |          |          |          |          |          |          |          |          |  |
|------|---------|----------------------|---------|---------|---------|----------|----------|----------|----------|----------|----------|----------|----------|----------|----------|--|
|      |         | 500 psi              | 600 psi | 700 psi | 800 psi | 1000 psi | 1200 psi | 1500 psi | 2000 psi | 2500 psi | 3000 psi | 3500 psi | 4000 psi | 4500 psi | 5000 psi |  |
| 02   | 0.034   | 0.7                  | 0.8     | 0.8     | 0.9     | 1.0      | 1.1      | 1.2      | 1.4      | 1.6      | 1.7      | 1.9      | 2.0      | 2.1      | 2.2      |  |
| 025  | 0.039   | 0.9                  | 1.0     | 1.1     | 1.1     | 1.3      | 1.4      | 1.5      | 1.8      | 2.0      | 2.2      | 2.3      | 2.5      | 2.7      | 2.8      |  |
| 03   | 0.043   | 1.1                  | 1.2     | 1.3     | 1.3     | 1.5      | 1.6      | 1.8      | 2.1      | 2.4      | 2.6      | 2.8      | 3.0      | 3.2      | 3.4      |  |
| 035  | 0.048   | 1.2                  | 1.4     | 1.5     | 1.6     | 1.8      | 1.9      | 2.1      | 2.5      | 2.9      | 3.0      | 3.3      | 3.5      | 3.7      | 3.9      |  |
| 04   | 0.052   | 1.4                  | 1.6     | 1.7     | 1.8     | 2.0      | 2.2      | 2.5      | 2.9      | 3.2      | 3.5      | 3.7      | 4.0      | 4.2      | 4.5      |  |
| 045  | 0.055   | 1.6                  | 1.7     | 1.9     | 2.0     | 2.3      | 2.5      | 2.9      | 3.2      | 3.6      | 3.9      | 4.2      | 4.5      | 4.8      | 5.0      |  |
| 05   | 0.057   | 1.8                  | 1.9     | 2.1     | 2.2     | 2.5      | 2.7      | 3.1      | 3.5      | 4.0      | 4.3      | 4.7      | 5.0      | 5.3      | 5.6      |  |
| 055  | 0.060   | 1.9                  | 2.1     | 2.3     | 2.5     | 2.8      | 3.0      | 3.4      | 3.9      | 4.4      | 4.8      | 5.1      | 5.5      | 5.8      | 6.2      |  |
| 06   | 0.062   | 2.1                  | 2.3     | 2.5     | 2.7     | 3.0      | 3.3      | 3.7      | 4.2      | 4.7      | 5.2      | 5.6      | 6.0      | 6.4      | 6.7      |  |
| 065  | 0.064   | 2.3                  | 2.5     | 2.7     | 2.9     | 3.3      | 3.6      | 4.0      | 4.6      | 5.1      | 5.6      | 6.1      | 6.5      | 6.9      | 7.3      |  |
| 07   | 0.067   | 2.5                  | 2.7     | 2.9     | 3.1     | 3.5      | 3.8      | 4.3      | 5.0      | 5.5      | 6.1      | 6.5      | 7.0      | 7.4      | 7.8      |  |
| 075  | 0.070   | 2.7                  | 2.9     | 3.1     | 3.4     | 3.8      | 4.1      | 4.6      | 5.3      | 5.9      | 6.5      | 7.0      | 7.5      | 8.0      | 8.4      |  |
| 08   | 0.072   | 2.8                  | 3.1     | 3.4     | 3.6     | 4.0      | 4.4      | 4.9      | 5.7      | 6.3      | 6.9      | 7.5      | 8.0      | 8.5      | 8.9      |  |
| 085  | 0.074   | 3.0                  | 3.3     | 3.6     | 3.8     | 4.3      | 4.7      | 5.2      | 6.0      | 6.7      | 7.4      | 8.0      | 8.5      | 9.0      | 9.5      |  |
| 09   | 0.076   | 3.2                  | 3.5     | 3.8     | 4.0     | 4.5      | 4.9      | 5.5      | 6.4      | 7.1      | 7.8      | 8.4      | 9.0      | 9.6      | 10.1     |  |
| 095  | 0.078   | 3.4                  | 3.7     | 4.0     | 4.3     | 4.8      | 5.2      | 5.8      | 6.7      | 7.5      | 8.2      | 8.8      | 9.4      | 10.0     | 10.7     |  |
| 10   | 0.080   | 3.5                  | 3.9     | 4.2     | 4.5     | 5.0      | 5.5      | 6.1      | 7.1      | 7.9      | 8.7      | 9.4      | 10.0     | 10.6     | 11.2     |  |
| 11   | 0.083   | 3.9                  | 4.3     | 4.6     | 4.9     | 5.5      | 6.0      | 6.7      | 7.8      | 8.7      | 9.5      | 10.1     | 10.7     | 11.3     | 12.0     |  |
| 12   | 0.087   | 4.2                  | 4.7     | 5.0     | 5.4     | 6.0      | 6.6      | 7.4      | 8.5      | 9.5      | 10.4     | 11.2     | 12.0     | 12.7     | 13.4     |  |
| 125  | 0.089   | 4.4                  | 4.8     | 5.2     | 5.6     | 6.3      | 6.9      | 7.7      | 8.9      | 9.9      | 10.8     | 11.6     | 12.4     | 13.2     | 14.0     |  |
| 13   | 0.091   | 4.6                  | 5.0     | 5.4     | 5.8     | 6.5      | 7.1      | 8.0      | 9.2      | 10.3     | 11.3     | 12.1     | 12.9     | 13.7     | 14.5     |  |
| 14   | 0.093   | 5.0                  | 5.4     | 5.9     | 6.3     | 7.0      | 7.7      | 8.6      | 9.9      | 11.1     | 12.1     | 12.9     | 13.7     | 14.5     | 15.3     |  |
| 15   | 0.096   | 5.3                  | 5.8     | 6.3     | 6.7     | 7.5      | 8.2      | 9.2      | 10.6     | 11.9     | 13.0     | 14.1     | 15.0     | 15.9     | 16.8     |  |
| 20   | 0.109   | 7.1                  | 7.8     | 8.4     | 8.9     | 10.0     | 11.0     | 12.3     | 14.1     | 15.8     | 17.3     | 18.4     | 19.5     | 20.6     | 21.7     |  |

## Nozzle recommendation (2 to 5 nozzles)

| Pump capacity | Size   | Quantity of Nozzles / Pressure in psi: |           |           |           |      |
|---------------|--------|--|-----------|-----------|-----------|------|
|               |        | 2 Nozzles                              | 3 Nozzles | 4 Nozzles | 5 Nozzles |      |
| 4 gpm         | 02     | 4000                                   | 1800      | 1000      | 700       |      |
|               | 025    | 2200                                   | 1000      | 600       | -         |      |
|               | 03     | 1900                                   | 750       | -         | -         |      |
|               | 04     | 1000                                   | -         | -         | -         |      |
| 5 gpm         | 02     | -                                      | 2600      | 1500      | 1000      |      |
|               | 025    | 4000                                   | 1800      | 900       | 600       |      |
|               | 03     | 2700                                   | 1300      | 600       | -         |      |
|               | 04     | 1500                                   | 650       | -         | -         |      |
|               | 05     | 1000                                   | -         | -         | -         |      |
| 6 gpm         | 02     | -                                      | 4400      | 2250      | 1600      |      |
|               | 025    | -                                      | 2200      | 1300      | 900       |      |
|               | 03     | 4000                                   | 1900      | 1000      | 650       |      |
|               | 04     | 2400                                   | 1000      | 550       | -         |      |
|               | 05     | 1400                                   | 550       | -         | -         |      |
|               | 06     | 1000                                   | 450       | -         | -         |      |
| 8 gpm         | 02     | -                                      | -         | 4000      | 2500      |      |
|               | 025    | -                                      | -         | 2200      | 1500      |      |
|               | 03     | -                                      | 3200      | 1900      | 1100      |      |
|               | 04     | 4000                                   | 1800      | 1000      | 600       |      |
|               | 05     | 2500                                   | 1100      | 650       | -         |      |
|               | 06     | 1800                                   | 800       | -         | -         |      |
|               | 07     | 1300                                   | -         | -         | -         |      |
| 10 gpm        | 02     | -                                      | -         | -         | 4000      |      |
|               | 025    | -                                      | -         | 4000      | 2200      |      |
|               | 03     | -                                      | -         | 2750      | 1800      |      |
|               | 04     | -                                      | 2800      | 1500      | 1000      |      |
|               | 05     | 4000                                   | 1700      | 1000      | 650       |      |
|               | 06     | 2750                                   | 1300      | 700       | -         |      |
|               | 07     | 2000                                   | 900       | 500       | -         |      |
|               | 08     | 1500                                   | 650       | -         | -         |      |
|               | 09     | 1200                                   | -         | -         | -         |      |
| 15 gpm        | 03     | -                                      | -         | -         | 4000      |      |
|               | 04     | -                                      | -         | 3750      | 2200      |      |
|               | 05     | -                                      | 4000      | 2200      | 1400      |      |
|               | 06     | -                                      | 2750      | 1500      | 1000      |      |
|               | 07     | -                                      | 2000      | 1150      | 750       |      |
|               | 08     | 3500                                   | 1500      | 850       | 550       |      |
|               | 09     | 2800                                   | 1200      | 700       | -         |      |
|               | 10     | 2250                                   | 1000      | 550       | -         |      |
|               | 20 gpm | 04                                     | -         | -         | -         | 4000 |
|               |        | 05                                     | -         | -         | 4000      | 2500 |
| 06            |        | -                                      | -         | 2750      | 1700      |      |
| 07            |        | -                                      | 3600      | 2000      | 1300      |      |
| 08            |        | -                                      | 2800      | 1500      | 1000      |      |
| 09            |        | -                                      | 2200      | 1200      | 800       |      |
| 10            |        | 4000                                   | 1850      | 1000      | 640       |      |



### Ceramic nozzle (with swivel nut\*)

| Part No. | IN      | Angle | Size |
|----------|---------|-------|------|
| 29.076*  | 03/8" F | 80°   | 040  |
| 29.076   | ---     | 80°   | 040  |



### Foam nozzle

| Part No. | IN        | Angle | Size |
|----------|-----------|-------|------|
| 18.50400 | 1/8" NPTM | 50°   | 400  |



### Stabilizer Nozzle

| Part No. | IN        |
|----------|-----------|
| 14.901   | 1/4" NPTM |
| 14.902   | 1/8" NPTM |

Legend

M. = metric thrust, M = male, F = female, Ø = gas pipe thrust, R = gas pipe thrust conical, QV = quick connects, SV = profile ring fitting, D = diameter, L = length, NW = nominal width, SW = wrench size, IN = male input, OUT = male output, RB = basic position

- ✓ Cut cleaning in half
- ✓ Wider coverage with a 0° spray

The Mosmatic Turbo Nozzle increases your Cleaning coverage. The 0 degree rotation creates a penetrating chiselling action, saving you time and money. Use this high pressure upgrade solution for hard surface applications such as concrete, graffiti removal or mud-encrusted vehicles. Changing from a flat fan nozzle to a Turbo Nozzle will highly increase the cleaning efficiency.

**Important: Always start turbo nozzles in down position. Do not use unprotected!**



### Turbo Nozzle «Rex»

| Part No. | IN        | Size | Color      | max. Press. | max. Temp. | Weight  |
|----------|-----------|------|------------|-------------|------------|---------|
| 14.150   | 1/4" NPTF | 3.0  | yellow     | 5800 psi    | 212°F      | 1.3 lbs |
| 14.151   |           | 3.5  | purple     |             |            |         |
| 14.152   |           | 4.0  | brown      |             |            |         |
| 14.153   |           | 4.5  | lime       |             |            |         |
| 14.154   |           | 5.0  | black      |             |            |         |
| 14.155   |           | 5.5  | light blue |             |            |         |
| 14.156   |           | 6.0  | red        |             |            |         |
| 14.157   |           | 6.5  | white      |             |            |         |
| 14.158   |           | 7.0  | pink       |             |            |         |
| 14.159   |           | 8.0  | orange     |             |            |         |
| 14.160   |           | 9.0  | green      |             |            |         |
| 14.161   |           | 10.0 | grey       |             |            |         |

|        |           |      |            |          |       |         |
|--------|-----------|------|------------|----------|-------|---------|
| 14.170 | 1/2" NPTF | 3.0  | yellow     | 3600 psi | 212°F | 1.3 lbs |
| 14.171 |           | 3.5  | purple     |          |       |         |
| 14.172 |           | 4.0  | brown      |          |       |         |
| 14.173 |           | 4.5  | lime       |          |       |         |
| 14.174 |           | 5.0  | black      |          |       |         |
| 14.175 |           | 5.5  | light blue |          |       |         |
| 14.176 |           | 6.0  | red        |          |       |         |
| 14.177 |           | 6.5  | white      |          |       |         |
| 14.178 |           | 7.0  | pink       |          |       |         |
| 14.179 |           | 8.0  | orange     |          |       |         |
| 14.180 |           | 9.0  | green      |          |       |         |
| 14.181 |           | 10.0 | grey       |          |       |         |

Other sizes upon request.



### Turbo Nozzle «Rex small»

| Part No. | IN        | Size | Color      | max. Press. | max. Temp. | Weight  |
|----------|-----------|------|------------|-------------|------------|---------|
| 14.942   | 1/4" NPTF | 4.0  | brown      | 3600 psi    | 212°F      | 0.7 lbs |
| 14.944   |           | 5.5  | light blue |             |            |         |

Other sizes upon request.



### Turbo Nozzle «iRex»

| Part No. | IN        | Size | Color      | max. Press. | max. Temp. | Weight  |
|----------|-----------|------|------------|-------------|------------|---------|
| 14.250   | 1/4" NPTF | 3.0  | yellow     | 3600 psi    | 194°F      | 1.3 lbs |
| 14.251   |           | 3.5  | purple     |             |            |         |
| 14.252   |           | 4.0  | brown      |             |            |         |
| 14.253   |           | 4.5  | lime       |             |            |         |
| 14.254   |           | 5.0  | black      |             |            |         |
| 14.255   |           | 5.5  | light blue |             |            |         |
| 14.256   |           | 6.0  | red        |             |            |         |
| 14.257   |           | 6.5  | white      |             |            |         |
| 14.258   |           | 7.0  | pink       |             |            |         |
| 14.259   |           | 8.0  | orange     |             |            |         |
| 14.260   |           | 9.0  | green      |             |            |         |
| 14.261   |           | 10.0 | grey       |             |            |         |

Other sizes upon request.



### Hydro Digging Turbo Nozzle «iRex»

| Part No. | IN        | Size | Color  | max. Press. | max. Temp. | Weight  |
|----------|-----------|------|--------|-------------|------------|---------|
| 14.279   | 1/2" NPTF | 8.0  | orange | 2900 psi    | 194°F      | 1.3 lbs |
| 14.280   |           | 9.0  | green  |             |            |         |
| 14.281   |           | 10.0 | grey   |             |            |         |

Other sizes upon request.



### Rotor Nozzle «MOSjet», slow rotating

| Part No. | IN        | Size | Spray angle | max. Press. | max. Temp. | Weight   |
|----------|-----------|------|-------------|-------------|------------|----------|
| 14.946   | 1/4" NPTF | 020  | 24°         | 5000 psi    | 194°F      | 0.55 lbs |
| 14.947   |           | 040  |             |             |            |          |

Other sizes upon request.

#### Legend

M. = metric thrust, .M. = male, F. = female, B. = gas pipe thrust, R. = gas pipe thrust control, QV = quick connect, SV = profile ring fitting, D = diameter, L = length, NW = nominal width, SW = insertion size, IN = male input, OUT = male output, RG = basic position



| Adeptor with sieve                  | Part No.      | Weight   |  |
|-------------------------------------|---------------|----------|--|
| IN 3/8" NPTF, OUT 3/8" NPTM, MC 50  | <b>53.011</b> | 0.13 lbs |  |
| IN 3/8" NPTF, OUT 3/8" NPTM, MC 200 | <b>53.012</b> | 0.13 lbs |  |
| IN 1/2" NPTF, OUT 1/2" NPTM, MC 50  | <b>53.015</b> | 0.13 lbs |  |
| IN 1/2" NPTF, OUT 1/2" NPTM, MC 200 | <b>53.016</b> | 0.13 lbs |  |

MC = Mesh count

| Ball Valve 2-way        | Part No.      | Weight   |  |
|-------------------------|---------------|----------|--|
| IN G1/4" F, OUT G1/4" F | <b>90.066</b> | 0.93 lbs |  |
| IN G3/8" F, OUT G3/8" F | <b>90.100</b> | 1.17 lbs |  |
| IN G1/2" F, OUT G1/2" F | <b>90.110</b> | 1.41 lbs |  |

| Extension fitting                                  | Part No.     | Weight  |  |
|--|--------------|---------|--|
| for DR-520 roof cleaner<br>IN G3/8" F, OUT G3/8" M | <b>38217</b> | 0.1 lbs |  |

| Extension for surface cleaner               | Part No.      | Weight  |  |
|---|---------------|---------|--|
| 17", stainless<br>IN M22x1.5 F, OUT G1/4" M | <b>78.908</b> | 0.7 lbs |  |

| Hand grip replacement kit   | Part No.      | Weight  |  |
|-----------------------------|---------------|---------|--|
| for Surface Cleaner ø8"/12" | <b>78.945</b> | 0.4 lbs |  |

| Height adjusters long   | Part No.       | Weight  |  |
|-------------------------|----------------|---------|--|
| for DR-520 roof cleaner | <b>904.351</b> | 0.4 lbs |  |

| High pressure filter        | Part No.      | Weight   |  |
|-----------------------------|---------------|----------|--|
| IN 1/4" NPTF, OUT 1/4" NPTM | <b>90.061</b> | 0.4 lbs  |  |
| IN 3/8" NPTF, OUT 3/8" NPTM | <b>90.063</b> | 0.55 lbs |  |

| HP Quick connect coupler<br>stainless steel, 5000 psi | Part No.      | Weight   |  |
|---|---------------|----------|--|
| 1/4" NPTF, D 0.47", NW 1/4", SW 0.87"                 | <b>70.015</b> | 0.13 lbs |  |
| 1/4" NPTM, D 0.47", NW 1/4", SW 0.67"                 | <b>70.016</b> | 0.18 lbs |  |
| 3/8" NPTF, D 0.61", NW 3/8", SW 0.94"                 | <b>70.017</b> | 0.22 lbs |  |
| 3/8" NPTM, D 0.61", NW 3/8", SW 0.94"                 | <b>70.018</b> | 0.22 lbs |  |

| HP Quick connect plug<br>stainless steel, 5000 psi | Part No.      | Weight   |  |
|--|---------------|----------|--|
| 1/4" NPTF, D 0.47", NW 1/4", SW 0.67"              | <b>70.025</b> | 0.05 lbs |  |
| 1/4" NPTM, D 0.47", NW 1/4", SW 0.57"              | <b>70.026</b> | 0.05 lbs |  |
| 3/8" NPTF, D 0.61", NW 3/8", SW 0.87"              | <b>70.027</b> | 0.13 lbs |  |
| 3/8" NPTM, D 0.61", NW 3/8", SW 0.67"              | <b>70.028</b> | 0.13 lbs |  |

| Mosmatic HP Gun «NEO»   | Part No.      | Weight  |  |
|---|---------------|---------|--|
| 5000 psi, 300°F, Low Trigger Force<br>IN 3/8" NPTF, OUT 1/4" NPTF | <b>29.081</b> | 1.3 lbs |  |
| 8700 psi, 300°F, Low Trigger Force<br>IN 1/2" NPTF, OUT 1/2" NPTF | <b>29.136</b> | 1.5 lbs |  |

More products see HP Gun page.

| Nozzle guard  | Part No.      | Weight   |  |
|---|---------------|----------|--|
| plug on ø0.6" & G3/8"<br>Other versions upon request. | <b>29.010</b> | 0.02 lbs |  |

More products upon request.

| Nozzles   | Part No.       | Weight   |  |
|---|----------------|----------|--|
| Nozzle package #2 for AQUA surface cleaner              | <b>78.983</b>  | 0.09 lbs |  |
| Low pressure upgrade kit for Hurricane-Series           | <b>80.9011</b> | 8.4 lbs  |  |
| Gum remover nozzle, IN G1/4" F<br>Size #3               | <b>29.102</b>  | 1.3 lbs  |  |
| Gum remover nozzle, IN G1/4" F<br>Size #4               | <b>29.103</b>  | 1.3 lbs  |  |
| Gum remover nozzle, IN G1/4" F<br>Size #5               | <b>29.119</b>  | 1.3 lbs  |  |
| Ceramic nozzle, 80° angle<br>Size 180 (Ø40), IN G3/8" F | <b>29.076</b>  | 0.04 lbs |  |

| Pedal switch   | Part No.      | Weight   |  |
|--|---------------|----------|--|
| for DR-520 roof cleaner<br>IN M22x1.5 M, OUT M22x1.5 F | <b>80.987</b> | 31.0 lbs |  |

| Prop stand         | Part No.       | Weight  |  |
|--------------------|----------------|---------|--|
| for HURF-300, 3.3' | <b>78.9012</b> | 0.2 lbs |  |

| Protection plate                 | Part No.       | Weight  |  |
|----------------------------------|----------------|---------|--|
| for Surface Cleaner ø8"          | <b>902.922</b> | 0.4 lbs |  |
| for Surface Cleaner ø12"         | <b>900.066</b> | 1.2 lbs |  |
| for Duct Cleaner ø12", stainless | <b>901.022</b> | 1.5 lbs |  |
| for Duct Cleaner ø16", stainless | <b>901.023</b> | 2.9 lbs |  |
| for Duct Cleaner ø20", stainless | <b>901.024</b> | 4.6 lbs |  |
| for Duct Cleaner ø24", stainless | <b>901.025</b> | 6.6 lbs |  |
| Screw-set                        | <b>81.942</b>  | 0.1 lbs |  |

| Quick connection                  | Part No.      | Weight   |  |
|-----------------------------------|---------------|----------|--|
| IN M22x1.5 F, OUT 1/4", NW 1/8"   | <b>50.131</b> | 0.15 lbs |  |
| IN M22x1.5 F, OUT 5/16", NW 7/32" | <b>50.132</b> | 0.15 lbs |  |
| IN M22x1.5 F, OUT 3/8", NW 1/4"   | <b>50.133</b> | 0.13 lbs |  |

| Stabilizer Nozzle               | Part No.      | Weight  |  |
|---------------------------------|---------------|---------|--|
| 1/4" NPTM, 3.7"                 | <b>14.901</b> | 0.2 lbs |  |
| 1/8" NPTM, 3.7"                 | <b>14.902</b> | 0.2 lbs |  |
| 1/8" NPTM, 2.7"                 | <b>14.935</b> | 0.2 lbs |  |
| 1/4" NPTM, 2.8"                 | <b>14.939</b> | 0.2 lbs |  |
| Quick connect plug ø0.47", 4.1" | <b>14.940</b> | 0.2 lbs |  |

| Swivel for paint spray guns | Part No.      | Weight  |  |
|-----------------------------|---------------|---------|--|
| IN 1/4" NPTF, OUT 1/8" M    | <b>32.906</b> | 0.8 lbs |  |
| IN 1/8" NPTF, OUT 1/8" M    | <b>32.910</b> | 0.8 lbs |  |
| IN 1/4" NPTF, OUT 1/4" M    | <b>32.915</b> | 0.9 lbs |  |

| Toggle joint  | Part No.      | Weight   |  |
|---|---------------|----------|--|
| 4000 psi, 250°F<br>IN 1/4" NPTF, OUT 1/4" NPTF, NW 1/8" | <b>42.051</b> | 0.53 lbs |  |

| TYR Hook                    | Part No.      | Weight  |  |
|-----------------------------|---------------|---------|--|
| stabilize your Duct Cleaner | <b>81.905</b> | 0.2 lbs |  |

| TYR Mobile (adjustable) | Part No.      | Weight   |  |
|-------------------------|---------------|----------|--|
| for ø6"-12" pipe        | <b>81.911</b> | 9.0 lbs  |  |
| for ø12"-20" pipe       | <b>81.902</b> | 9.5 lbs  |  |
| for ø20"-24" pipe       | <b>81.903</b> | 15.6 lbs |  |

Duct Cleaner not included.



**Our goal:**

**To provide quality and reliability in design and performance.**

# ROTARY UNIONS

## **Car Wash Industry**

Rim cleaning, self-service car wash, undercarriage or touchless wash systems, Mosmatic swivels have been a source for all major manufacturers.



## **High Pressure Cleaning Industry**

With a proven design portfolio, Mosmatic offers a complete line of low and high rpm designs. From product advancements to exotic applications such as sea water we can assist, provide or design something for you.



## **Hydraulics and Pneumatics**

Provide longer life and reliability to your hydraulic or high pressure hose applications with Mosmatic large variety of swivels.



## **Industrial Cleaning**

With clean compact low profile designing, Mosmatic swivels can be integrated into many different application and installation areas. Don't compromise performance and design when we can assist with the right union for your needs.



**OPTIMAL** **ALTERNATIVE**

| Application                  | IMGV | IMGVI | IMGK | IMGS | DKS | IGE | IGE1 | IGR | WDE | WDE1 | WDE1LP | WDG | WDB | WDC | WDRS | DGL | DGG | DGF | DXL | DXG | DXF | DXTI | DXLS | DXGS | DXFS | DYL | DYG | DYF | DYW | DYU/DYDI | DYU/DYDU | DYKI | Q/S |  |  |
|------------------------------|------|-------|------|------|-----|-----|------|-----|-----|------|--------|-----|-----|-----|------|-----|-----|-----|-----|-----|-----|------|------|------|------|-----|-----|-----|-----|----------|----------|------|-----|--|--|
| Agriculture                  |      |       |      |      |     |     |      |     |     |      |        |     |     |     |      |     |     |     |     |     |     |      |      |      |      |     |     |     |     |          |          |      |     |  |  |
| Automatic carwashes          |      |       |      |      |     |     |      |     |     |      |        |     |     |     |      |     |     |     |     |     |     |      |      |      |      |     |     |     |     |          |          |      |     |  |  |
| Bus/Train/Truck wash systems |      |       |      |      |     |     |      |     |     |      |        |     |     |     |      |     |     |     |     |     |     |      |      |      |      |     |     |     |     |          |          |      |     |  |  |
| Ceiling Boom                 |      |       |      |      |     |     |      |     |     |      |        |     |     |     |      |     |     |     |     |     |     |      |      |      |      |     |     |     |     |          |          |      |     |  |  |
| Compressed air guns          |      |       |      |      |     |     |      |     |     |      |        |     |     |     |      |     |     |     |     |     |     |      |      |      |      |     |     |     |     |          |          |      |     |  |  |
| Container wash               |      |       |      |      |     |     |      |     |     |      |        |     |     |     |      |     |     |     |     |     |     |      |      |      |      |     |     |     |     |          |          |      |     |  |  |
| Conveyor belt cleaning       |      |       |      |      |     |     |      |     |     |      |        |     |     |     |      |     |     |     |     |     |     |      |      |      |      |     |     |     |     |          |          |      |     |  |  |
| Duct cleaning                |      |       |      |      |     |     |      |     |     |      |        |     |     |     |      |     |     |     |     |     |     |      |      |      |      |     |     |     |     |          |          |      |     |  |  |
| Fire Service                 |      |       |      |      |     |     |      |     |     |      |        |     |     |     |      |     |     |     |     |     |     |      |      |      |      |     |     |     |     |          |          |      |     |  |  |
| Fishnet cleaning             |      |       |      |      |     |     |      |     |     |      |        |     |     |     |      |     |     |     |     |     |     |      |      |      |      |     |     |     |     |          |          |      |     |  |  |
| Fleet wash                   |      |       |      |      |     |     |      |     |     |      |        |     |     |     |      |     |     |     |     |     |     |      |      |      |      |     |     |     |     |          |          |      |     |  |  |
| Food Industry                |      |       |      |      |     |     |      |     |     |      |        |     |     |     |      |     |     |     |     |     |     |      |      |      |      |     |     |     |     |          |          |      |     |  |  |
| Hose                         |      |       |      |      |     |     |      |     |     |      |        |     |     |     |      |     |     |     |     |     |     |      |      |      |      |     |     |     |     |          |          |      |     |  |  |
| Hose reels                   |      |       |      |      |     |     |      |     |     |      |        |     |     |     |      |     |     |     |     |     |     |      |      |      |      |     |     |     |     |          |          |      |     |  |  |
| HP-Cleaner                   |      |       |      |      |     |     |      |     |     |      |        |     |     |     |      |     |     |     |     |     |     |      |      |      |      |     |     |     |     |          |          |      |     |  |  |
| HP-Guns                      |      |       |      |      |     |     |      |     |     |      |        |     |     |     |      |     |     |     |     |     |     |      |      |      |      |     |     |     |     |          |          |      |     |  |  |
| Hydraulic                    |      |       |      |      |     |     |      |     |     |      |        |     |     |     |      |     |     |     |     |     |     |      |      |      |      |     |     |     |     |          |          |      |     |  |  |
| Mining Industry              |      |       |      |      |     |     |      |     |     |      |        |     |     |     |      |     |     |     |     |     |     |      |      |      |      |     |     |     |     |          |          |      |     |  |  |
| Municipal vehicle            |      |       |      |      |     |     |      |     |     |      |        |     |     |     |      |     |     |     |     |     |     |      |      |      |      |     |     |     |     |          |          |      |     |  |  |
| Paint guns                   |      |       |      |      |     |     |      |     |     |      |        |     |     |     |      |     |     |     |     |     |     |      |      |      |      |     |     |     |     |          |          |      |     |  |  |
| Paint Industry               |      |       |      |      |     |     |      |     |     |      |        |     |     |     |      |     |     |     |     |     |     |      |      |      |      |     |     |     |     |          |          |      |     |  |  |
| Parts washer                 |      |       |      |      |     |     |      |     |     |      |        |     |     |     |      |     |     |     |     |     |     |      |      |      |      |     |     |     |     |          |          |      |     |  |  |
| Pipe cleaning                |      |       |      |      |     |     |      |     |     |      |        |     |     |     |      |     |     |     |     |     |     |      |      |      |      |     |     |     |     |          |          |      |     |  |  |
| Pneumatic                    |      |       |      |      |     |     |      |     |     |      |        |     |     |     |      |     |     |     |     |     |     |      |      |      |      |     |     |     |     |          |          |      |     |  |  |
| Salt water                   |      |       |      |      |     |     |      |     |     |      |        |     |     |     |      |     |     |     |     |     |     |      |      |      |      |     |     |     |     |          |          |      |     |  |  |
| Self-foaming application     |      |       |      |      |     |     |      |     |     |      |        |     |     |     |      |     |     |     |     |     |     |      |      |      |      |     |     |     |     |          |          |      |     |  |  |
| Surface Cleaner              |      |       |      |      |     |     |      |     |     |      |        |     |     |     |      |     |     |     |     |     |     |      |      |      |      |     |     |     |     |          |          |      |     |  |  |
| Tire cleaning                |      |       |      |      |     |     |      |     |     |      |        |     |     |     |      |     |     |     |     |     |     |      |      |      |      |     |     |     |     |          |          |      |     |  |  |
| Touchless carwash            |      |       |      |      |     |     |      |     |     |      |        |     |     |     |      |     |     |     |     |     |     |      |      |      |      |     |     |     |     |          |          |      |     |  |  |
| Tunnel wash systems          |      |       |      |      |     |     |      |     |     |      |        |     |     |     |      |     |     |     |     |     |     |      |      |      |      |     |     |     |     |          |          |      |     |  |  |
| Wands                        |      |       |      |      |     |     |      |     |     |      |        |     |     |     |      |     |     |     |     |     |     |      |      |      |      |     |     |     |     |          |          |      |     |  |  |
| Wheel washer                 |      |       |      |      |     |     |      |     |     |      |        |     |     |     |      |     |     |     |     |     |     |      |      |      |      |     |     |     |     |          |          |      |     |  |  |

If you don't see your application on the chart, please contact us.

| <b>Inline + 90° Swivels</b>              | Nominal width  | Seal System | Pressure max. (psi) | RPM max. (rpm) | Temp. max. (°F) | Type | Page  |
|--|----------------|-------------|---------------------|----------------|-----------------|------|-------|
| Swivels, single bearing system           | NW 1/4" - 3/8" | O-ring      | 4000                | 30             | 250             | DGV  | 68    |
| Swivels, single bearing system           | NW 1/4"        |             | 7300/5000           | 30             | 250             | DGVI | 69    |
| Swivels, single bearing system, short    | NW 1/8" - 1/4" |             | 4000                | 30             | 250             | DGK  | 70-71 |
| Swivels, dual bearing system             | NW 1/4" - 3/8" |             | 4000                | 30             | 250             | DGS  | 72    |
| Swivel couplings, single bearing system  | NW 1/8" - 1/4" |             | 3600                | 30             | 250             | DKS  | 73    |
| Hi flo Swivels, single bearing system    | NW 3/8" - 1/2" |             | 2900/4000           | 30             | 250             | DGE  | 74    |
| Hi flo Swivels, triple bearing system    | NW 3/8" - 1/2" |             | 2900/5000           | 30             | 250             | DGEI | 75    |
| Hi flo Swivels, quadruple bearing system | NW 1/2" - 2"   |             | 150-3000            | 70-200         | 40-180          | DGR  | 76    |

|   |                  |        |                  |        |         |                 |    |
|---|------------------|--------|------------------|--------|---------|-----------------|----|
| 90° Swivels                             | NW 1/4" - 1/2"   | O-ring | 4000             | 30     | 250     | WDE             | 77 |
| 90° Swivels                             | NW 1/4" - 1"     |        | 3000/5800<br>725 | 30     | 250     | WDEI<br>WDEI LP | 78 |
| 90° Swivels                             | NW 1/4" - 1/2"   |        | 2200/4000        | 30     | 200/250 | WDG             | 79 |
| 90° Swivels, dual bearing system        | NW 1/4" - 3/8"   |        | 4000             | 30-200 | 250     | WDB             | 80 |
| 90° Swivels, dual bearing system        | NW 1/2"          |        | 4000             | 30-200 | 250     | WDC             | 81 |
| Hi flo 90° Swivels, dual bearing system | NW 3/8" - 2 1/2" |        | 150-3000         | 60-150 | 40-180  | WDRS            | 82 |

**High RPM Swivels**

|   |                |        |      |      |    |     |    |
|---|----------------|--------|------|------|----|-----|----|
| Swivels, triple bearing system                        | NW 1/4" - 3/8" | O-ring | 4000 | 1000 | 90 | DGL | 83 |
| Swivels, triple bearing system, with bulkhead fitting | NW 1/4" - 3/8" |        | 4000 | 1000 | 90 | DGG | 84 |
| Swivels, triple bearing system, with flange           | NW 1/4" - 3/8" |        | 4000 | 1000 | 90 | DGF | 85 |

|   |                |         |      |      |        |                     |    |
|---|----------------|---------|------|------|--------|---------------------|----|
| Swivels, triple bearing system                        | NW 1/4"        | Ceramic | 2500 | 2000 | 40-250 | DXL                 | 86 |
| Swivels, triple bearing system                        | NW 1/4"        |         | 300  | 1000 | 350    | DXLS / DXGS<br>DXFS | 87 |
| Swivels, triple bearing system, with bulkhead fitting | NW 1/4"        |         | 2500 | 2000 | 40-250 | DXG                 | 88 |
| Swivels, triple bearing system, with flange           | NW 1/4"        |         | 2500 | 2000 | 40-250 | DXF                 | 89 |
| Swivels, quadruple bearing system                     | NW 1/4" - 1/2" |         | 2500 | 2000 | 250    | DXTI                | 90 |

|   |                |         |           |      |     |             |    |
|---|----------------|---------|-----------|------|-----|-------------|----|
| Swivels, triple bearing system                        | NW 1/4"        | Carbide | 4000      | 2000 | 250 | DYL         | 91 |
| Swivels, triple bearing system, with bulkhead fitting | NW 1/4" - 3/8" |         | 4000      | 2000 | 250 | DYG         | 92 |
| Swivels, triple bearing system, with flange           | NW 1/4"        |         | 4000      | 2000 | 250 | DYF         | 93 |
| Swivels, triple bearing system                        | NW 1/4"        |         | 5000      | 2000 | 250 | DYW         | 94 |
| Swivels, triple bearing system                        | NW 1/4"        |         | 5000/7500 | 2000 | 250 | DYCI / DYDI | 95 |
| Swivels, quadruple bearing system                     | NW 1/4" - 3/8" |         | 5000/7500 | 2000 | 250 | DYT / DYU   | 96 |
| Swivels, quadruple bearing system                     | NW 1/4" - 3/8" |         | 5000      | 2000 | 250 | DYKI        | 97 |

**Accessories**

|                |  |  |  |  |  |     |    |
|----------------|--|--|--|--|--|-----|----|
| Quick connects |  |  |  |  |  | QVS | 98 |
|----------------|--|--|--|--|--|-----|----|

Additional Seal Options available  
 EPDM (E) or FKM/Viton (V). Please indicate letter of seal material after part number.



- ✓ Live rotation under maximum pressure
- ✓ Single bearing system
- ✓ Stainless steel internal parts
- ✓ Corrosion resistant
- ✓ Reinforced inner shaft
- ✓ Maintenance free

## Application

HP-Guns, hose connections, hydraulics, tangle-free applications

### TECHNICAL DATA

|                          |  |
|--------------------------|--|
| <b>Pressure</b>          | 4000 psi (27.5 MPa)  |
| <b>Temperature</b>       | 250°F  |
| <b>RPM</b>               | max. 30 rpm  |
| <b>Body</b>              | stainless steel<br>brass, nickel plated                    |
| <b>Inner part</b>        | stainless steel  |
| <b>Seal</b>              | O-ring NBR<br>(optional: EPDM or FKM)                      |
| <b>Bearing</b>           | Tx thrust ball bearing                                     |
| <b>Throughput medium</b> | pH 3-12<br>filtered 10 microns<br>compressed air (290 psi) |

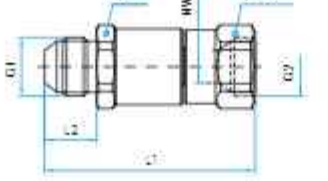
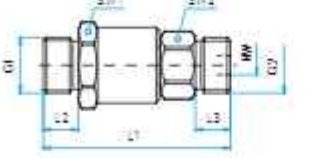
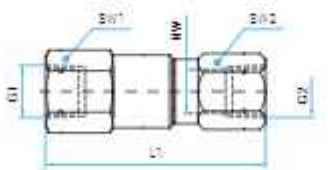
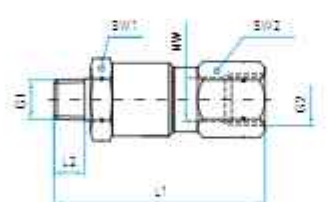
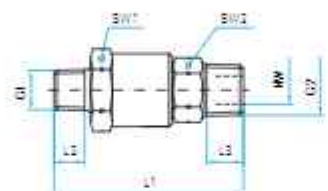
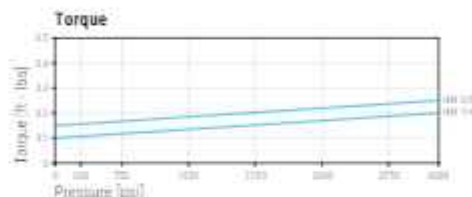
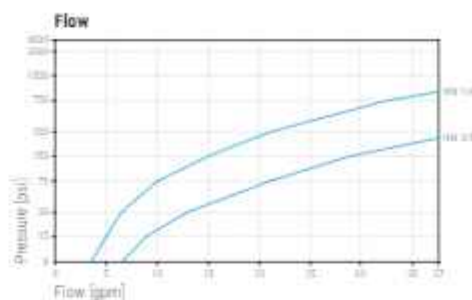

### DGV

| Part No. | G1 (M)    | G2 (M)    | NW   | SW1  | SW2  | L1   | L2   | L3   | Weight |
|----------|-----------|-----------|------|------|------|------|------|------|--------|
| 32.551   | 1/4" NPTM | 1/4" NPTM | 1/4" | 0.94 | 0.67 | 2.40 | 0.39 | 0.43 | 4.2 oz |
| 32.553   | 1/4" NPTM | 3/8" NPTM | 1/4" | 0.94 | 0.75 | 2.44 | 0.39 | 0.47 | 4.9 oz |
| 32.561   | 3/8" NPTM | 1/4" NPTM | 1/4" | 0.94 | 0.67 | 2.44 | 0.43 | 0.43 | 4.9 oz |
| 32.563   | 3/8" NPTM | 3/8" NPTM | 1/4" | 0.94 | 0.75 | 2.49 | 0.43 | 0.47 | 5.4 oz |
| 32.861   | 1/2" NPTM | 3/8" NPTM | 3/8" | 1.06 | 0.75 | 2.75 | 0.59 | 0.47 | 7.5 oz |
| 32.863   | 1/2" NPTM | 1/2" NPTM | 3/8" | 1.06 | 1.06 | 2.91 | 0.59 | 0.59 | 8.2 oz |

| Part No. | G1 (M)    | G2 (F)    | NW   | SW1  | SW2  | L1   | L2   | Weight |
|----------|-----------|-----------|------|------|------|------|------|--------|
| 32.552   | 1/4" NPTM | 1/4" NPTF | 1/4" | 0.94 | 0.75 | 2.60 | 0.39 | 5.2 oz |
| 32.554   | 1/4" NPTM | 3/8" NPTF | 1/4" | 0.94 | 0.87 | 2.71 | 0.39 | 5.6 oz |
| 32.562   | 3/8" NPTM | 1/4" NPTF | 1/4" | 0.94 | 0.75 | 2.69 | 0.43 | 5.7 oz |
| 32.564   | 3/8" NPTM | 3/8" NPTF | 1/4" | 0.94 | 0.87 | 2.75 | 0.43 | 6.2 oz |
| 32.852   | 3/8" NPTM | 3/8" NPTF | 3/8" | 1.06 | 0.87 | 2.87 | 0.43 | 6.4 oz |
| 32.854   | 3/8" NPTM | 1/2" NPTF | 3/8" | 1.06 | 1.06 | 2.87 | 0.43 | 7.1 oz |
| 32.864   | 1/2" NPTM | 1/2" NPTF | 3/8" | 1.06 | 1.06 | 3.03 | 0.59 | 8.7 oz |

| Part No. | G1 (F)    | G2 (F)    | NW   | SW1  | SW2  | L1   | Weight |
|----------|-----------|-----------|------|------|------|------|--------|
| 32.557   | 1/4" NPTF | 1/4" NPTF | 1/4" | 0.94 | 0.75 | 2.72 | 6.9 oz |
| 32.559   | 1/4" NPTF | 3/8" NPTF | 1/4" | 0.94 | 0.87 | 2.83 | 6.6 oz |
| 32.567   | 3/8" NPTF | 1/4" NPTF | 1/4" | 0.94 | 0.75 | 2.76 | 6.6 oz |
| 32.569   | 3/8" NPTF | 3/8" NPTF | 1/4" | 0.94 | 0.87 | 2.87 | 7.1 oz |

### DGV Face seal

| Part No. | G1 (M)      | G2 (M)      | NW   | SW1  | SW2  | L1   | L2   | L3   | Weight |
|----------|-------------|-------------|------|------|------|------|------|------|--------|
| 32.571   | 11/16"-16UN | 11/16"-16UN | 1/4" | 0.94 | 0.87 | 2.32 | 0.43 | 0.43 | 4.9 oz |
| 32.871   | 13/16"-16UN | 13/16"-16UN | 3/8" | 1.06 | 0.94 | 2.44 | 0.43 | 0.43 | 6.5 oz |

### DGV Hydraulic

| Part No. | G1 (M)     | G2 (F)     | NW   | SW1  | SW2  | L1   | L2   | Weight |
|----------|------------|------------|------|------|------|------|------|--------|
| 32.926   | 3/4" JIC M | 3/4" JIC F | 3/8" | 1.00 | 1.00 | 2.71 | 0.67 | 6.0 oz |

DGV Heat Shield see DGV1 page.

WWW.MOSMATIC.COM

- ✓ Live rotation under maximum pressure
- ✓ Complete stainless steel construction
- ✓ Single bearing system
- ✓ Corrosion resistant
- ✓ Maintenance free



### Application

HF-guns, high pressure hose reels, hydraulics, tangle-free applications

### TECHNICAL DATA

|                          |  |
|--------------------------|--|
| <b>Pressure</b>          | 7300 psi (50 MPa)<br>5000 psi* (35 MPa)                    |
| <b>Temperature</b>       | 250°F  |
| <b>RPM</b>               | max. 30 rpm  |
| <b>Body</b>              | stainless steel  |
| <b>Inner part</b>        | stainless steel  |
| <b>Seal</b>              | O-ring NBR<br>(optional: EPDM or FKM)                      |
| <b>Bearing</b>           | Tx thrust ball bearing                                     |
| <b>Throughput medium</b> | pH 3-12<br>filtered 10 microns<br>compressed air (290 psi) |

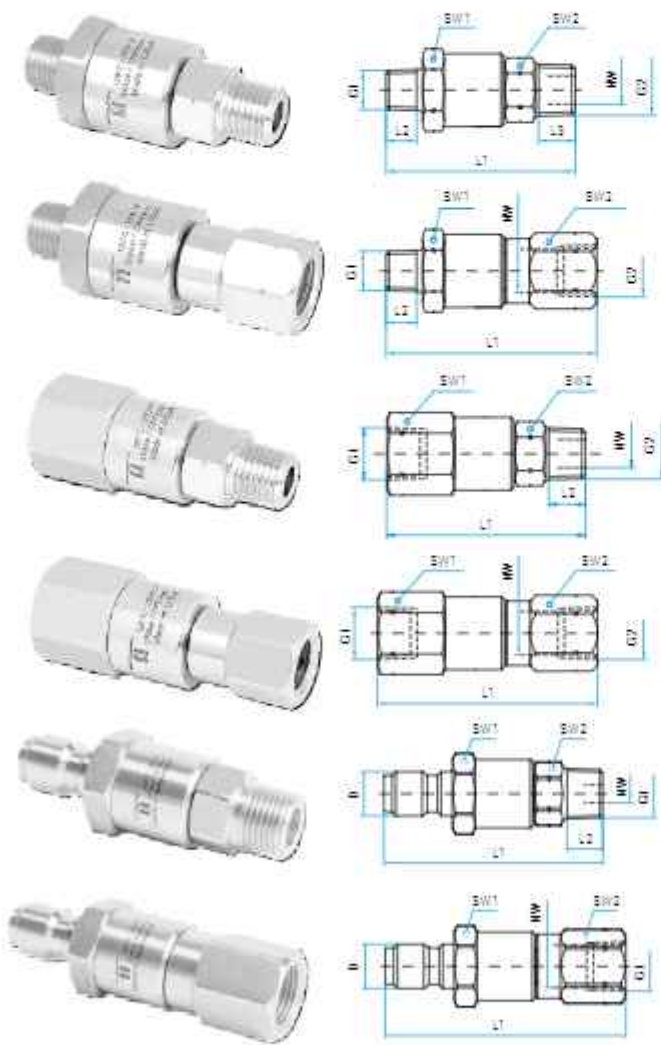
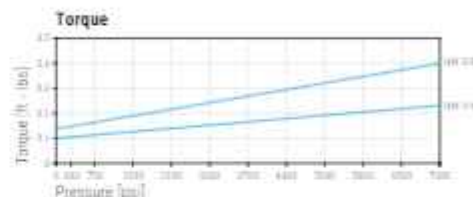
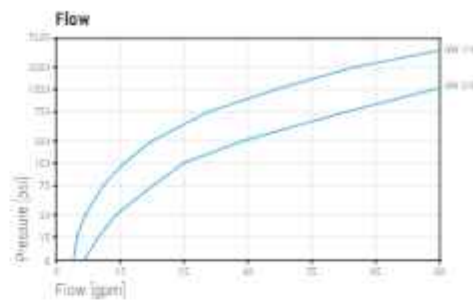

### DGVI

| Part No. | G1 (M)    | G2 (M)    | NW   | SW1  | SW2  | L1   | L2   | L3   | Weight |
|----------|-----------|-----------|------|------|------|------|------|------|--------|
| 32.763   | 3/8" NPTM | 3/8" NPTM | 1/4" | 0.94 | 0.75 | 2.48 | 0.43 | 0.47 | 5.4 oz |

| Part No. | G1 (M)    | G2 (F)    | NW   | SW1  | SW2  | L1   | L2   | Weight |
|----------|-----------|-----------|------|------|------|------|------|--------|
| 32.752   | 1/4" NPTM | 1/4" NPTF | 1/4" | 0.94 | 0.75 | 2.60 | 0.39 | 5.2 oz |
| 32.764   | 3/8" NPTM | 3/8" NPTF | 1/4" | 0.94 | 0.87 | 2.75 | 0.43 | 6.4 oz |
| 32.894   | 1/2" NPTM | 1/2" NPTF | 3/8" | 1.06 | 1.06 | 2.95 | 0.59 | 8.8 oz |

| Part No. | G1 (F)    | G2 (M)    | NW   | SW1  | SW2  | L1   | L2   | Weight |
|----------|-----------|-----------|------|------|------|------|------|--------|
| 32.768   | 3/8" NPTF | 3/8" NPTM | 1/4" | 0.94 | 0.75 | 2.60 | 0.47 | 5.9 oz |

| Part No. | G1 (F)    | G2 (F)    | NW   | SW1  | SW2  | L1   | Weight |
|----------|-----------|-----------|------|------|------|------|--------|
| 32.769   | 3/8" NPTF | 3/8" NPTF | 1/4" | 0.94 | 0.87 | 2.87 | 7.1 oz |

### DGVI with quick connect plug

| Part No. | D      | G1 (M)    | NW   | SW1  | SW2  | L1   | L2   | Weight |
|----------|--------|-----------|------|------|------|------|------|--------|
| 32.773*  | ±0.47" | 1/4" NPTM | 1/4" | 0.94 | 0.67 | 2.80 | 0.43 | 4.2 oz |
| 32.778*  | ±0.50" | 3/8" NPTM | 1/4" | 0.94 | 0.75 | 2.90 | 0.47 | 5.1 oz |

| Part No. | D      | G1 (F)    | NW   | SW1  | SW2  | L1   | Weight |
|----------|--------|-----------|------|------|------|------|--------|
| 32.774*  | ±0.47" | 1/4" NPTF | 1/4" | 0.94 | 0.75 | 3.00 | 5.0 oz |
| 32.779*  | ±0.50" | 3/8" NPTF | 1/4" | 0.94 | 0.87 | 3.20 | 6.2 oz |

### DGVI Heat Shield

| Part No. | Material  | Screw    | Weight |
|----------|-----------|----------|--------|
| 28.973** | PA, black | included | 1.2 oz |

\*\* minimum order quantity 15 pcs

### Legend

M. = metric thread, ...M = male, F = female, B = gas pipe thread, R = gas pipe thread optional, QV = quick connects  
 SW = profiling fitting, D = diameter, L = length, NW = nominal width, SW = seal size

### Additional Seal Options available

EPDM (E) or FKM/Viton (V). Please indicate letter of seal material after part number. Minimum orders apply.

WWW.MOSMATIC.COM



- ✓ Maintenance free
- ✓ Multitude of configurations
- ✓ Live rotation at maximum pressure
- ✓ Compact design

### Application

HP-Guns, hose connections, hydraulics, tangle-free applications

### TECHNICAL DATA

**Pressure** 4000 psi (27.5 MPa)  
**Temperature** 250°F  
**RPM** max. 30 rpm

**Body** stainless steel  
brass, nickel plated

**Inner part** stainless steel  
**Seal** O-ring NBR  
(optional: EPDM or FKM)  
**Bearing** Tx thrust ball bearing

**Throughput medium** pH 3-12  
filtered 10 microns  
compressed air (290 psi)

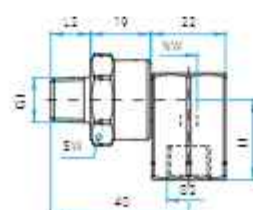
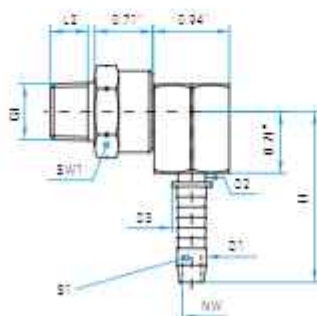
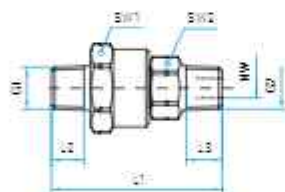
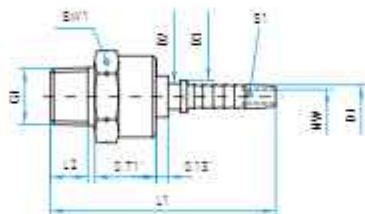
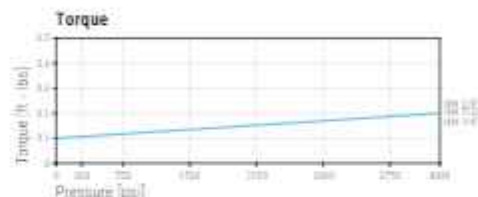
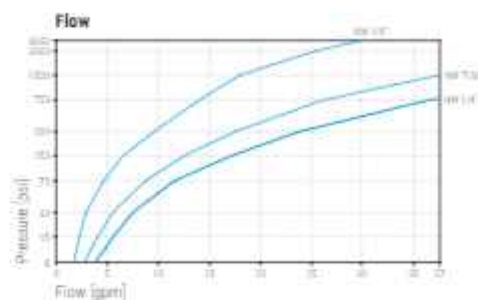

### DGK

| Part No. | G1 (M)    | S1    | NW    | SW1  | L1   | L2   | D1   | D2   | D3   | Weight |
|----------|-----------|-------|-------|------|------|------|------|------|------|--------|
| 32.081   | 1/4" NPTM | 1/4"  | 1/8"  | 0.94 | 2.55 | 0.39 | 0.27 | 0.29 | 0.37 | 2.6 oz |
| 32.082   | 1/4" NPTM | 5/16" | 7/32" | 0.94 | 2.68 | 0.39 | 0.33 | 0.34 | 0.44 | 2.8 oz |
| 32.089   | 1/4" NPTM | 3/8"  | 1/4"  | 0.94 | 2.70 | 0.39 | 0.40 | 0.42 | 0.54 | 2.6 oz |
| 32.181   | 3/8" NPTM | 1/4"  | 1/8"  | 0.94 | 2.39 | 0.43 | 0.27 | 0.29 | 0.37 | 3.2 oz |
| 32.182   | 3/8" NPTM | 5/16" | 7/32" | 0.94 | 2.68 | 0.43 | 0.33 | 0.34 | 0.44 | 3.3 oz |
| 32.189   | 3/8" NPTM | 3/8"  | 1/4"  | 0.94 | 2.76 | 0.43 | 0.40 | 0.42 | 0.54 | 4.6 oz |

### DGK (single bearing, compact)

| Part No. | G1 (M)    | G2 (M)    | NW   | SW1  | SW2  | L1   | L2   | L3   | Weight |
|----------|-----------|-----------|------|------|------|------|------|------|--------|
| 32.051   | 1/4" NPTM | 1/4" NPTM | 1/4" | 0.94 | 0.67 | 2.05 | 0.39 | 0.43 | 3.5 oz |
| 32.053   | 1/4" NPTM | 3/8" NPTM | 1/4" | 0.94 | 0.75 | 2.09 | 0.39 | 0.39 | 3.9 oz |
| 32.153   | 3/8" NPTM | 3/8" NPTM | 1/4" | 0.94 | 0.75 | 2.13 | 0.43 | 0.47 | 4.2 oz |

### DGK 90°

| Part No. | G1 (M)    | S1    | NW    | SW1  | L1   | L2   | D1   | D2   | D3   | Weight |
|----------|-----------|-------|-------|------|------|------|------|------|------|--------|
| 32.381   | 1/4" NPTM | 1/4"  | 1/8"  | 0.94 | 1.95 | 0.39 | 0.27 | 0.29 | 0.37 | 5.3 oz |
| 32.382   | 1/4" NPTM | 5/16" | 7/32" | 0.94 | 1.97 | 0.39 | 0.33 | 0.34 | 0.44 | 5.3 oz |
| 32.389   | 1/4" NPTM | 3/8"  | 1/4"  | 0.94 | 2.10 | 0.39 | 0.40 | 0.42 | 0.54 | 6.0 oz |
| 32.481   | 3/8" NPTM | 1/4"  | 1/8"  | 0.94 | 1.95 | 0.43 | 0.27 | 0.29 | 0.37 | 5.5 oz |
| 32.482   | 3/8" NPTM | 5/16" | 7/32" | 0.94 | 1.97 | 0.43 | 0.33 | 0.34 | 0.44 | 5.7 oz |
| 32.489   | 3/8" NPTM | 3/8"  | 1/4"  | 0.94 | 2.10 | 0.43 | 0.40 | 0.42 | 0.54 | 6.2 oz |

### DGK 90°

| Part No. | G1 (M)    | G1 (F)    | NW   | SW1  | L1   | L2   | Weight |
|----------|-----------|-----------|------|------|------|------|--------|
| 32.543   | 1/4" NPTM | 1/4" NPTF | 1/4" | 0.94 | 0.94 | 0.39 | 5.6 oz |
| 32.544   | 1/4" NPTM | 3/8" NPTF | 1/4" | 0.94 | 1.06 | 0.39 | 5.5 oz |
| 32.548   | 3/8" NPTM | 1/4" NPTF | 1/4" | 0.94 | 0.94 | 0.39 | 5.9 oz |
| 32.549   | 3/8" NPTM | 3/8" NPTF | 1/4" | 0.94 | 1.06 | 0.39 | 5.6 oz |

#### Legend

M. = metric thread, .M = male, F = female, B = gas pipe thread, R = gas pipe thread conical, QV = quick connects  
 SW = profiling fitting, D = diameter, L = length, NW = nominal width, SW = insertion size

#### Additional Seal Options available

EPDM (E) or FKM/Viton (V). Please indicate letter of seal material after part number. Minimum orders apply.



- ✓ Improved gun mobility
- ✓ Plug Nipple: ISO-6150 B-profile
- ✓ Spray guns and compressed air guns
- ✓ High quality design
- ✓ High quality swivel for use with your specific application



## Application

Compressed air guns, paint guns

### TECHNICAL DATA

|                          |  |
|--------------------------|--|
| <b>Pressure</b>          | 4000 psi (27.5 MPa)  |
| <b>Temperature</b>       | 250°F  |
| <b>RPM</b>               | max. 30 rpm  |
| <b>Body</b>              | stainless steel<br>brass, nickel plated                    |
| <b>Inner part</b>        | stainless steel  |
| <b>Seal</b>              | O-ring NBR<br>(optional: EPDM or FKM)                      |
| <b>Bearing</b>           | Tx thrust ball bearing                                     |
| <b>Throughput medium</b> | pH 3-12<br>filtered 10 microns<br>compressed air (290 psi) |

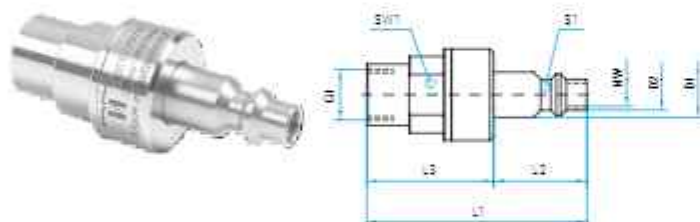
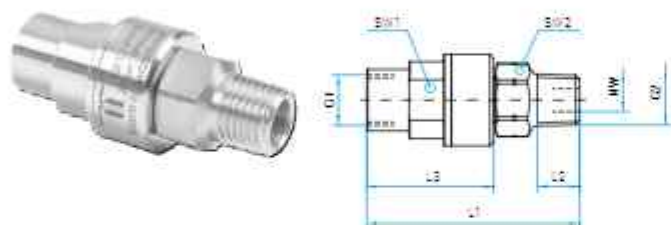
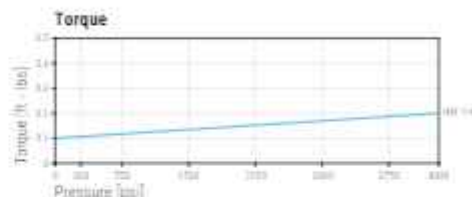
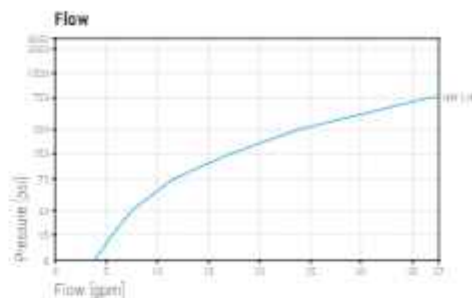

### DGK

| Part No. | G1 (F)  | G2 (M)    | NW   | SW1  | SW2  | L1   | L2   | L3   | Weight  |
|----------|---------|-----------|------|------|------|------|------|------|---------|
| 32.985   | G1/4" F | 1/4" NPTM | 1/4" | 0.67 | 0.67 | 2.16 | 0.43 | 1.30 | 3.2 oz. |

### DGK (ISO-6150 B-profile)

| Part No. | G1 (F)  | S1   | NW   | SW1  | L1   | L2   | L3   | D1   | D2   | Weight  |
|----------|---------|------|------|------|------|------|------|------|------|---------|
| 32.986   | G1/4" F | 1/4" | 1/4" | 0.67 | 2.24 | 0.94 | 1.30 | 0.46 | 0.31 | 2.8 oz. |

#### Legend

M. = metric thread, ...M = male, F = female, B = gas side thrust, R = gas side thrust optional, QV = quick connects  
 SW = profiling fitting, D = diameter, L = length, NW = nominal width, SW = swivel size

#### Additional Seal Options available

EPDM (E) or FKM/Viton (V). Please indicate letter of seal material after part number. Minimum orders apply.

- ✓ Very low torque
- ✓ Sealed stainless steel bearings
- ✓ Maintenance free
- ✓ Easy rotation at maximum pressure

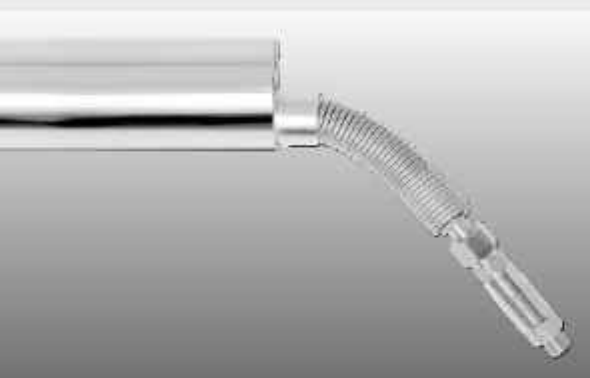

## Application

High and low pressure cleaning, hose connections, ceiling booms, hydraulic

### TECHNICAL DATA

|                          |  |
|--------------------------|--|
| <b>Pressure</b>          | 4000 psi (27.5 MPa)  |
| <b>Temperature</b>       | 250°F  |
| <b>RPM</b>               | max. 30 rpm  |
| <b>Body</b>              | brass, nickel plated                                       |
| <b>Inner part</b>        | stainless steel  |
| <b>Seal</b>              | O-ring NBR<br>(optional EPDM or FKM)                       |
| <b>Bearing</b>           | 1x thrust ball bearing<br>1x radial ball bearing           |
| <b>Throughput medium</b> | pH 3-12<br>filtered 10 microns<br>compressed air (290 psi) |

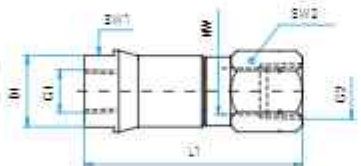
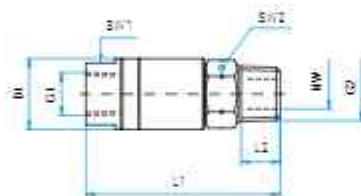
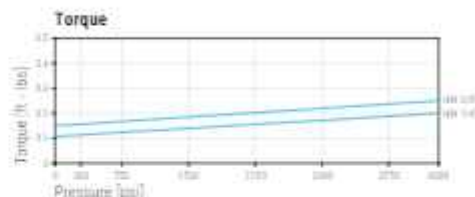
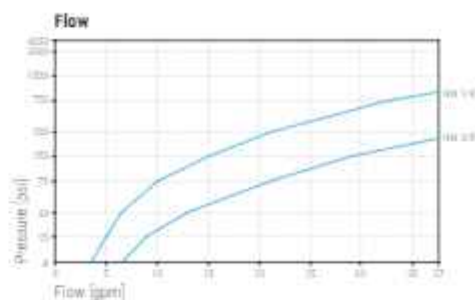

### DGS

| Part No. | G1 (F)    | G2 (M)    | NW   | SW1  | SW2  | L1   | L2   | D1   | Weight |
|----------|-----------|-----------|------|------|------|------|------|------|--------|
| 30.051   | 1/4" NPTF | 1/4" NPTM | 1/4" | 0.75 | 0.67 | 2.92 | 0.48 | 0.86 | 4.1 oz |
| 30.053   | 1/4" NPTF | 3/8" NPTM | 1/4" | 0.75 | 0.75 | 2.36 | 0.47 | 0.86 | 4.6 oz |
| 30.153   | 3/8" NPTF | 3/8" NPTM | 1/4" | 0.87 | 0.75 | 2.36 | 0.47 | 0.98 | 4.6 oz |
| 30.653   | 3/8" NPTF | 3/8" NPTM | 3/8" | 0.87 | 0.75 | 2.43 | 0.47 | 0.98 | 6.0 oz |

| Part No. | G1 (F)    | G2 (F)    | NW   | SW1  | SW2  | L1   | D1   | Weight |
|----------|-----------|-----------|------|------|------|------|------|--------|
| 30.014   | G1/4" F   | 3/8" NPTF | 1/4" | 0.75 | 0.87 | 2.63 | 0.86 | 5.5 oz |
| 30.052   | 1/4" NPTF | 1/4" NPTF | 1/4" | 0.75 | 0.75 | 2.52 | 0.86 | 4.9 oz |
| 30.054   | 1/4" NPTF | 3/8" NPTF | 1/4" | 0.75 | 0.87 | 2.63 | 0.86 | 5.6 oz |
| 30.154   | 3/8" NPTF | 3/8" NPTF | 1/4" | 0.87 | 0.87 | 2.63 | 0.98 | 5.6 oz |
| 30.654   | 3/8" NPTF | 3/8" NPTF | 3/8" | 0.87 | 0.87 | 2.71 | 0.98 | 6.0 oz |

#### Legend

M. = metric thread, M = male, F = female, B = gas side thrust, R = gas side thrust control, QV = quick connects, SW = profiling fitting, D = diameter, L = length, NW = nominal width, SW = hexagon size.

#### Additional Seal Options available

EPDM (E) or FKM/Viton (V). Please indicate letter of seal material after part number. Minimum orders apply.

- ✓ Live rotation under maximum pressure
- ✓ Single bearing system
- ✓ Self-lubricating ball bearings
- ✓ Easy to install

## Application

High pressure cleaning, hose connections, quick coupling

### TECHNICAL DATA

|                          |  |
|--------------------------|--|
| <b>Pressure</b>          | 3600 psi (25 MPa)  |
| <b>Temperature</b>       | 250°F  |
| <b>RPM</b>               | max. 30 rpm  |
| <b>Body</b>              | brass, nickel plated                                       |
| <b>Inner part</b>        | stainless steel  |
| <b>Seal</b>              | O-ring NBR<br>(optional: EPDM or FKM)                      |
| <b>Bearing</b>           | 1x thrust ball bearing                                     |
| <b>Throughput medium</b> | pH 3-12<br>filtered 10 microns<br>compressed air (290 psi) |

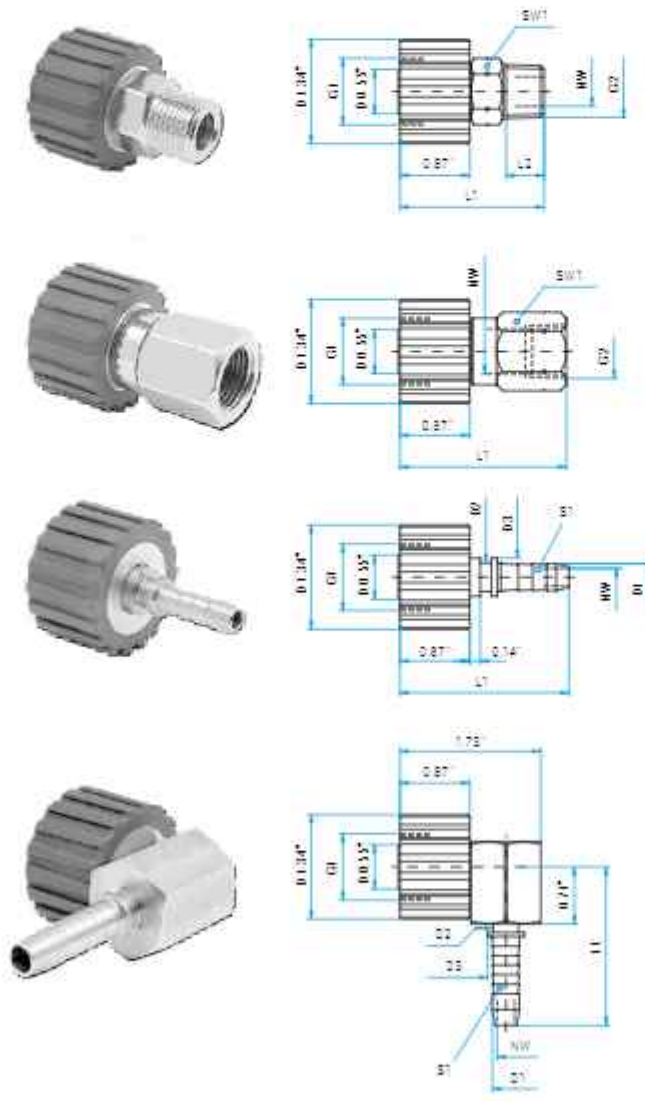
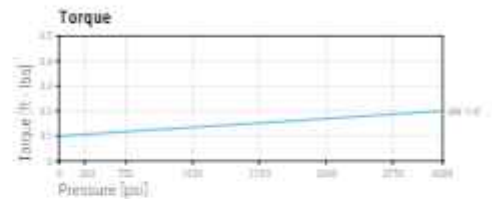
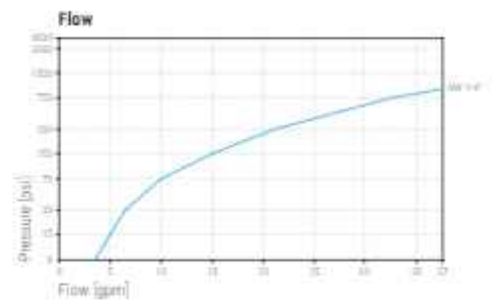

### DKS

| Part No. | G1 (QV)   | G2 (M)    | NW   | SW1  | L1   | L2   | Weight  | Color |
|----------|-----------|-----------|------|------|------|------|---------|-------|
| 70.051   | M21x1.5 F | 1/4" NPTM | 1/4" | 0.67 | 1.76 | 0.43 | 3.6 oz. | gray  |
| 70.053   | M21x1.5 F | 3/8" NPTM | 1/4" | 0.75 | 1.80 | 0.47 | 3.6 oz. | gray  |
| 70.151   | M22x1.5 F | 1/4" NPTM | 1/4" | 0.67 | 1.76 | 0.43 | 3.7 oz. | red   |
| 70.153   | M22x1.5 F | 3/8" NPTM | 1/4" | 0.75 | 1.80 | 0.47 | 3.7 oz. | red   |

| Part No. | G1 (Qv)   | G2 (F)    | NW   | SW1  | L1   | Weight  | Color |
|----------|-----------|-----------|------|------|------|---------|-------|
| 70.052   | M21x1.5 F | 1/4" NPTF | 1/4" | 0.75 | 1.96 | 3.6 oz. | gray  |
| 70.054   | M21x1.5 F | 3/8" NPTF | 1/4" | 0.67 | 2.08 | 3.6 oz. | gray  |
| 70.152   | M22x1.5 F | 1/4" NPTF | 1/4" | 0.75 | 1.96 | 3.7 oz. | red   |
| 70.154   | M22x1.5 F | 3/8" NPTF | 1/4" | 0.67 | 2.08 | 3.7 oz. | red   |

| Part No. | G1 (QV)   | G1    | NW    | L1   | D1   | D2   | D3   | Weight  | Color |
|----------|-----------|-------|-------|------|------|------|------|---------|-------|
| 70.131   | M22x1.5 F | 1/4"  | 7/8"  | 2.26 | 0.27 | 0.29 | 0.37 | 2.8 oz. | red   |
| 70.132   | M22x1.5 F | 5/16" | 7/32" | 2.34 | 0.33 | 0.34 | 0.44 | 3.0 oz. | red   |
| 70.139   | M22x1.5 F | 3/8"  | 1/4"  | 2.42 | 0.40 | 0.35 | 0.47 | 3.0 oz. | red   |

### DKS 90°

| Part No. | G1 (Qv)   | G1    | NW    | L1   | D1   | D2   | D3   | Weight  | Color |
|----------|-----------|-------|-------|------|------|------|------|---------|-------|
| 70.582   | M22x1.5 F | 5/16" | 7/32" | 1.97 | 0.33 | 0.31 | 0.45 | 5.7 oz. | red   |

#### Legend

M. = metric thread, ...M = male, F = female, B = gas pipe thread, R = gas pipe thread optional, QV = quick connects  
 SW = profiling fitting, D = diameter, L = length, NW = nominal width, SW = swivel size

#### Additional Seal Options available

EPDM (E) or FKM/Viton (V). Please indicate letter of seal material after part number.  
 Minimum orders apply.



- ✓ Maintenance free
- ✓ Sealed stainless steel bearings
- ✓ High flow

### Application

High flow, low rpm, automatic car wash systems, high pressure hose reels

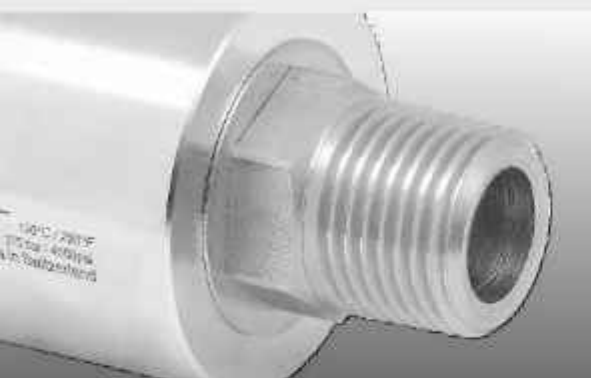

#### TECHNICAL DATA

|                          |  |
|--------------------------|--|
| <b>Pressure</b>          | 4000 psi (27.5 MPa)<br>2900 psi* (20 MPa)                  |
| <b>Temperature</b>       | 250°F  |
| <b>RPM</b>               | max. 30 rpm  |
| <b>Body</b>              | brass, nickel plated                                       |
| <b>Inner part</b>        | stainless steel  |
| <b>Seal</b>              | O-ring NBR<br>(optional: EPDM or FKM)                      |
| <b>Bearing</b>           | Tx thrust ball bearing                                     |
| <b>Throughput medium</b> | pH 3-12<br>filtered 10 microns<br>compressed air (290 psi) |

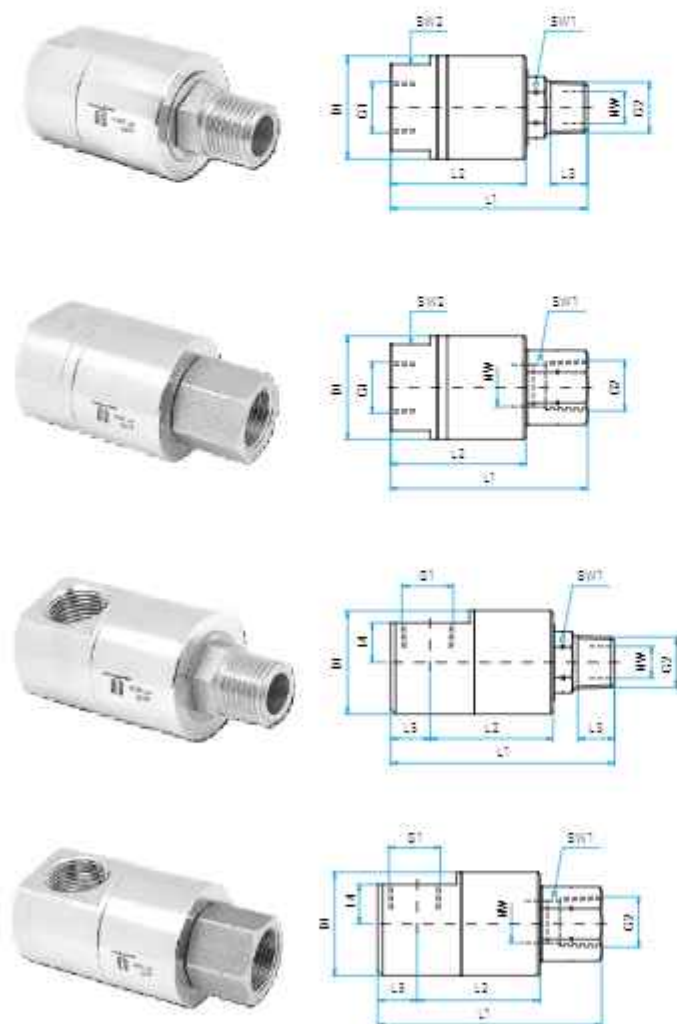
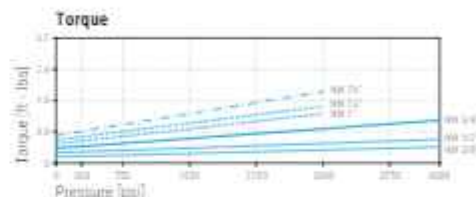
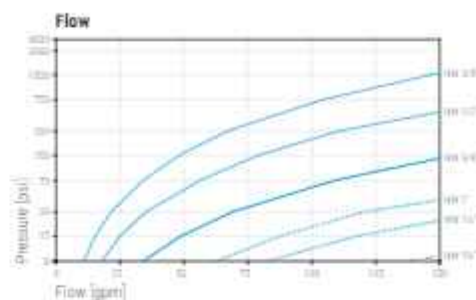

#### DGE

| Part No. | G1 (F)      | G2 (M)      | NW     | SW1  | SW2  | L1   | L2   | L3   | D1   | Weight  |
|----------|-------------|-------------|--------|------|------|------|------|------|------|---------|
| 34.852   | 3/8" NPTF   | 3/8" NPTM   | 3/8"   | 0.87 | 1.38 | 2.67 | 2.05 | 0.43 | 1.65 | 18.9 oz |
| 34.853   | 1/2" NPTF   | 1/2" NPTM   | 1/2"   | 0.87 | 1.38 | 3.15 | 2.17 | 0.59 | 1.65 | 18.9 oz |
| 34.854   | 3/4" NPTF   | 3/4" NPTM   | 3/4"   | 1.06 | 1.57 | 3.45 | 2.38 | 0.63 | 1.97 | 27.8 oz |
| 34.855*  | 1" NPTF     | 1" NPTM     | 1"     | 1.42 | 1.97 | 3.54 | 2.35 | 0.71 | 2.35 | 40.3 oz |
| 34.856*  | 1 1/4" NPTF | 1 1/4" NPTM | 1 1/4" | 1.50 | 1.81 | 4.17 | 2.65 | 0.79 | 2.35 | 47.8 oz |
| 34.857*  | 1 1/2" NPTF | 1 1/2" NPTM | 1 1/2" | 2.05 | 2.76 | 4.41 | 2.67 | 0.79 | 3.35 | 95.3 oz |

| Part No. | G1 (F)      | G2 (F)      | NW     | SW1  | SW2  | L1   | L2   | D1   | Weight  |
|----------|-------------|-------------|--------|------|------|------|------|------|---------|
| 34.862   | 3/8" NPTF   | 3/8" NPTF   | 3/8"   | 0.87 | 1.38 | 2.81 | 2.05 | 1.65 | 10.4 oz |
| 34.863   | 1/2" NPTF   | 1/2" NPTF   | 1/2"   | 1.06 | 1.38 | 3.15 | 2.17 | 1.65 | 22.0 oz |
| 34.864   | 3/4" NPTF   | 3/4" NPTF   | 3/4"   | 1.26 | 1.57 | 3.39 | 2.38 | 1.97 | 31.8 oz |
| 34.865*  | 1" NPTF     | 1" NPTF     | 1"     | 1.42 | 1.97 | 3.55 | 2.35 | 2.35 | 44.0 oz |
| 34.866*  | 1 1/4" NPTF | 1 1/4" NPTF | 1 1/4" | 1.97 | 1.97 | 3.94 | 2.65 | 2.35 | 50.0 oz |
| 34.867*  | 1 1/2" NPTF | 1 1/2" NPTF | 1 1/2" | 2.13 | 2.76 | 4.15 | 2.87 | 3.35 | 93.9 oz |

#### DGE 90°

| Part No. | G1 (F)      | G2 (M)      | NW     | SW1  | L1   | L2   | L3   | L4   | L5   | D1   | Weight   |
|----------|-------------|-------------|--------|------|------|------|------|------|------|------|----------|
| 34.872   | 3/8" NPTF   | 3/8" NPTM   | 3/8"   | 0.87 | 3.31 | 1.93 | 0.43 | 0.67 | 0.55 | 1.65 | 22.5 oz  |
| 34.873   | 1/2" NPTF   | 1/2" NPTM   | 1/2"   | 0.87 | 3.58 | 2.01 | 0.59 | 0.63 | 0.59 | 1.65 | 23.2 oz  |
| 34.874   | 3/4" NPTF   | 3/4" NPTM   | 3/4"   | 1.06 | 4.09 | 2.26 | 0.63 | 0.75 | 0.75 | 1.97 | 35.7 oz  |
| 34.875*  | 1" NPTF     | 1" NPTM     | 1"     | 1.42 | 4.53 | 2.52 | 0.71 | 0.91 | 0.83 | 2.35 | 56.7 oz  |
| 34.876*  | 1 1/4" NPTF | 1 1/4" NPTM | 1 1/4" | 1.50 | 5.24 | 2.62 | 0.79 | 1.02 | 1.10 | 2.75 | 74.2 oz  |
| 34.877*  | 1 1/2" NPTF | 1 1/2" NPTM | 1 1/2" | 2.05 | 5.71 | 2.99 | 0.79 | 1.18 | 1.18 | 3.35 | 128.9 oz |

| Part No. | G1 (F)      | G2 (F)      | NW     | SW1  | L1   | L2   | L4   | L5   | D1   | Weight   |
|----------|-------------|-------------|--------|------|------|------|------|------|------|----------|
| 34.882   | 3/8" NPTF   | 3/8" NPTF   | 3/8"   | 0.87 | 3.25 | 1.93 | 0.67 | 0.55 | 1.65 | 23.5 oz  |
| 34.883   | 1/2" NPTF   | 1/2" NPTF   | 1/2"   | 1.06 | 3.58 | 2.01 | 0.63 | 0.59 | 1.65 | 22.8 oz  |
| 34.884   | 3/4" NPTF   | 3/4" NPTF   | 3/4"   | 1.26 | 4.02 | 2.26 | 0.75 | 0.75 | 1.97 | 35.0 oz  |
| 34.885*  | 1" NPTF     | 1" NPTF     | 1"     | 1.42 | 4.55 | 2.52 | 0.91 | 0.83 | 2.35 | 53.9 oz  |
| 34.886*  | 1 1/4" NPTF | 1 1/4" NPTF | 1 1/4" | 1.97 | 5.00 | 2.01 | 1.02 | 1.10 | 2.35 | 75.4 oz  |
| 34.887*  | 1 1/2" NPTF | 1 1/2" NPTF | 1 1/2" | 2.13 | 5.47 | 2.01 | 1.18 | 1.18 | 3.35 | 127.5 oz |

Legend

M. = metric thread, .M = male, F = female, B = gas side thrust, R = gas side thrust control, QV = quick connects  
 SW = profiling fitting, D = diameter, L = length, NW = nominal width, SW = hexagon size

Additional Seal Options available

EPDM (E) or FKM/Viton (V). Please indicate letter of seal material after part number.  
 Minimum orders apply.

- ✓ Stainless steel construction
- ✓ Maintenance free
- ✓ Sealed stainless steel ball bearings
- ✓ High flow



### Application

Pharmaceutical industry, food industry, high flow, low rpm, automatic car wash systems

#### TECHNICAL DATA

|                          |  |
|--------------------------|--|
| <b>Pressure</b>          | 5000 psi (35 MPa)<br>2900 psi* (20 MPa)                      |
| <b>Temperature</b>       | 250°F  |
| <b>RPM</b>               | max. 30 rpm  |
| <b>Body</b>              | stainless steel  |
| <b>Inner part</b>        | stainless steel  |
| <b>Seal</b>              | O-ring NBR<br>(optional: EPDM or FKM)                        |
| <b>Bearing</b>           | 1x thrust ball bearing<br>2x sliding bearings                |
| <b>Throughput medium</b> | pH 3 - 12<br>filtered 10 microns<br>compressed air (290 psi) |

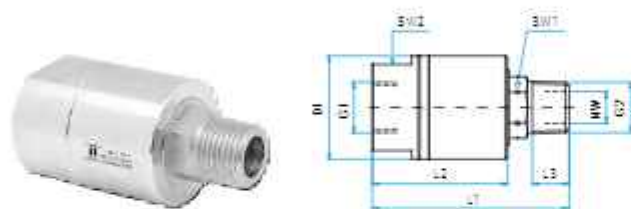
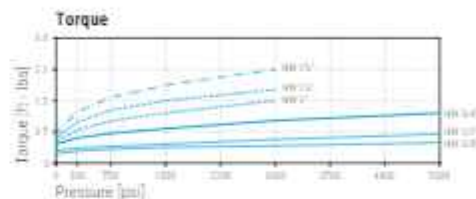
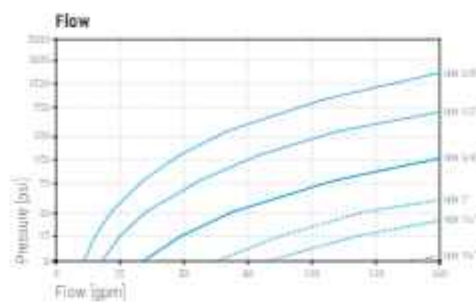

#### DGEI

| Part No. | G1 (F)      | G2 (M)      | NW     | SW1  | SW2  | L1   | L2   | L3   | D1   | Weight  |
|----------|-------------|-------------|--------|------|------|------|------|------|------|---------|
| 34.752   | 3/8" NPTF   | 3/8" NPTM   | 3/8"   | 0.87 | 1.38 | 2.67 | 2.05 | 0.43 | 1.65 | 18.9 oz |
| 34.753   | 1/2" NPTF   | 1/2" NPTM   | 1/2"   | 0.87 | 1.38 | 3.15 | 2.17 | 0.59 | 1.65 | 18.9 oz |
| 34.754   | 3/4" NPTF   | 3/4" NPTM   | 3/4"   | 1.05 | 1.58 | 3.65 | 2.58 | 0.63 | 1.97 | 27.8 oz |
| 34.755*  | 1" NPTF     | 1" NPTM     | 1"     | 1.42 | 1.97 | 3.74 | 2.56 | 0.71 | 2.35 | 40.3 oz |
| 34.756*  | 1 1/4" NPTF | 1 1/4" NPTM | 1 1/4" | 1.47 | 1.97 | 4.51 | 2.99 | 0.79 | 3.35 | 47.8 oz |
| 34.757*  | 1 1/2" NPTF | 1 1/2" NPTM | 1 1/2" | 1.97 | 2.75 | 4.61 | 3.07 | 0.79 | 3.33 | 95.0 oz |

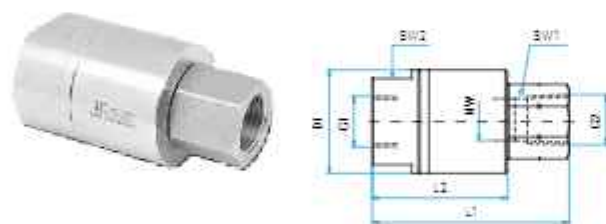

| Part No. | G1 (F)      | G2 (F)      | NW     | SW1  | SW2  | L1   | L2   | D1   | Weight  |
|----------|-------------|-------------|--------|------|------|------|------|------|---------|
| 34.762   | 3/8" NPTF   | 3/8" NPTF   | 3/8"   | 0.87 | 1.38 | 2.80 | 2.05 | 1.65 | 10.4 oz |
| 34.763   | 1/2" NPTF   | 1/2" NPTF   | 1/2"   | 1.06 | 1.38 | 3.15 | 2.17 | 1.65 | 22.0 oz |
| 34.764   | 3/4" NPTF   | 3/4" NPTF   | 3/4"   | 1.26 | 1.58 | 3.65 | 2.58 | 1.97 | 31.8 oz |
| 34.765*  | 1" NPTF     | 1" NPTF     | 1"     | 1.42 | 1.97 | 3.54 | 2.56 | 2.35 | 44.0 oz |
| 34.766*  | 1 1/4" NPTF | 1 1/4" NPTF | 1 1/4" | 1.97 | 1.97 | 4.23 | 2.99 | 2.35 | 50.0 oz |
| 34.767*  | 1 1/2" NPTF | 1 1/2" NPTF | 1 1/2" | 2.13 | 2.75 | 4.35 | 3.07 | 3.33 | 93.9 oz |



#### DGEI 90°

| Part No. | G1 (F)      | G2 (M)      | NW     | SW1  | L1   | L2   | L3   | L4   | L5   | D1   | Weight   |
|----------|-------------|-------------|--------|------|------|------|------|------|------|------|----------|
| 34.772   | 3/8" NPTF   | 3/8" NPTM   | 3/8"   | 0.87 | 3.46 | 2.09 | 0.43 | 0.67 | 0.55 | 1.65 | 22.5 oz  |
| 34.773   | 1/2" NPTF   | 1/2" NPTM   | 1/2"   | 0.87 | 3.82 | 2.09 | 0.59 | 0.63 | 0.75 | 1.65 | 23.2 oz  |
| 34.774   | 3/4" NPTF   | 3/4" NPTM   | 3/4"   | 1.06 | 4.35 | 2.40 | 0.63 | 0.75 | 0.87 | 1.97 | 35.7 oz  |
| 34.775*  | 1" NPTF     | 1" NPTM     | 1"     | 1.42 | 4.84 | 2.52 | 0.71 | 0.91 | 1.14 | 2.35 | 56.7 oz  |
| 34.776*  | 1 1/4" NPTF | 1 1/4" NPTM | 1 1/4" | 1.47 | 5.65 | 2.84 | 0.79 | 1.02 | 1.30 | 2.76 | 74.2 oz  |
| 34.777*  | 1 1/2" NPTF | 1 1/2" NPTM | 1 1/2" | 1.97 | 6.12 | 3.17 | 0.79 | 1.18 | 1.42 | 3.33 | 128.9 oz |

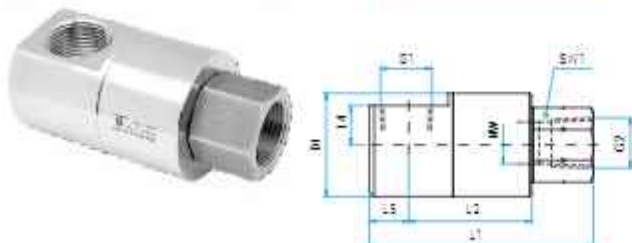

| Part No. | G1 (F)      | G2 (F)      | NW     | SW1  | L1   | L2   | L4   | L5   | D1   | Weight   |
|----------|-------------|-------------|--------|------|------|------|------|------|------|----------|
| 34.782   | 3/8" NPTF   | 3/8" NPTF   | 3/8"   | 0.87 | 3.39 | 2.09 | 0.67 | 0.55 | 1.65 | 23.5 oz  |
| 34.783   | 1/2" NPTF   | 1/2" NPTF   | 1/2"   | 1.06 | 3.82 | 2.09 | 0.63 | 0.75 | 1.65 | 22.8 oz  |
| 34.784   | 3/4" NPTF   | 3/4" NPTF   | 3/4"   | 1.26 | 4.35 | 2.40 | 0.75 | 0.87 | 1.97 | 36.0 oz  |
| 34.785*  | 1" NPTF     | 1" NPTF     | 1"     | 1.42 | 4.65 | 2.52 | 0.91 | 1.14 | 2.35 | 53.9 oz  |
| 34.786*  | 1 1/4" NPTF | 1 1/4" NPTF | 1 1/4" | 1.97 | 5.37 | 2.84 | 1.02 | 1.30 | 2.76 | 76.4 oz  |
| 34.787*  | 1 1/2" NPTF | 1 1/2" NPTF | 1 1/2" | 2.13 | 5.87 | 3.17 | 1.18 | 1.42 | 3.33 | 127.5 oz |

#### Legend

M. = metric thrust, ...M = male, F = female, B = gas side thrust, R = gas side thrust optional, QV = quick connects  
 SW = profiling fitting, D = diameter, L = length, NW = nominal width, SW = swivel size

#### Additional Seal Options available:

EPDM (E) or FKM/Viton (V). Please indicate letter of seal material after part number.  
 Minimum orders apply.



- ✓ Quadruple bearing system
- ✓ High flow
- ✓ Solid stainless steel construction
- ✓ Long service life
- ✓ Maintenance free
- ✓ Corrosion resistant

### Application

Thrust and radial forces, high pressure, industrial or food service applications

### TECHNICAL DATA

|                          |  |
|--------------------------|--|
| <b>Pressure</b>          | 150-3000 psi (1-20 MPa)<br>290 psi* (2 MPa)                  |
| <b>Temperature</b>       | 40°F - 180°F   |
| <b>RPM</b>               | see chart (max. RPM)   |
| <b>Body</b>              | stainless steel  |
| <b>Inner part</b>        | stainless steel  |
| <b>Seal</b>              | O-ring NBR<br>(optional: EPDM or FKM)                        |
| <b>Bearing</b>           | 2x radial ball bearings<br>2x thrust ball bearings           |
| <b>Throughput medium</b> | pH 3 - 12<br>filtered 10 microns<br>compressed air (290 psi) |

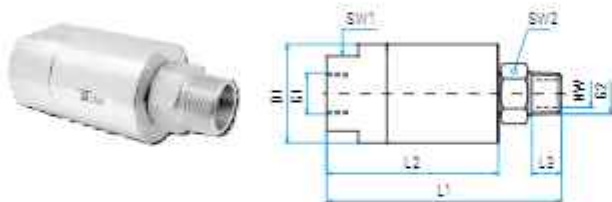
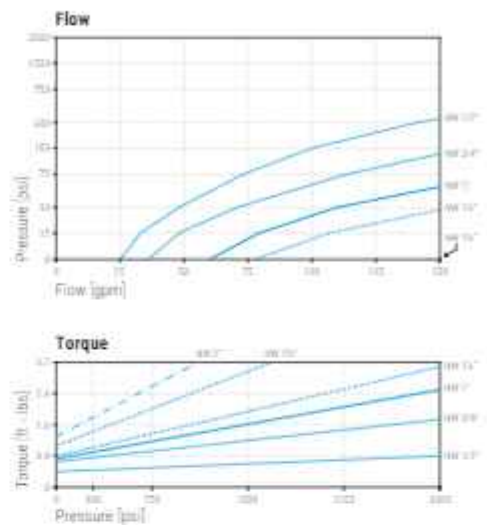

### DGR

| Part No. | G1 (F)      | G2 (M)      | NW     | SW1  | SW2  | L1   | L2   | L3   | D1   | max. RPM | Weight |
|----------|-------------|-------------|--------|------|------|------|------|------|------|----------|--------|
| 34.211   | 1/2" NPTF   | 1/2" NPTM   | 1/2"   | 1.50 | 1.06 | 4.69 | 3.43 | 0.59 | 1.97 | 200      | 41 oz  |
| 34.311   | 3/4" NPTF   | 3/4" NPTM   | 3/4"   | 1.65 | 1.26 | 5.00 | 3.66 | 0.59 | 2.17 | 150      | 51 oz  |
| 34.411   | 1" NPTF     | 1" NPTM     | 1"     | 1.81 | 1.42 | 5.51 | 3.78 | 0.71 | 2.36 | 130      | 59 oz  |
| 34.541   | 1 1/4" NPTF | 1 1/4" NPTM | 1 1/4" | 2.00 | 1.73 | 5.57 | 3.98 | 0.71 | 2.36 | 130      | 62 oz  |
| 34.511   | 1 1/2" NPTF | 1 1/2" NPTM | 1 1/2" | 2.55 | 2.17 | 6.05 | 4.09 | 0.79 | 3.15 | 100      | 111 oz |
| 34.611   | 2" NPTF     | 2" NPTM     | 2"     | 2.95 | 2.44 | 6.54 | 4.57 | 0.87 | 3.54 | 70       | 132 oz |
| 34.646*  | 2 1/2" NPTF | 2 1/2" NPTM | 2 1/2" | 3.35 | 3.35 | 10.9 | 8.53 | 1.14 | 6.30 | 50       | 713 oz |

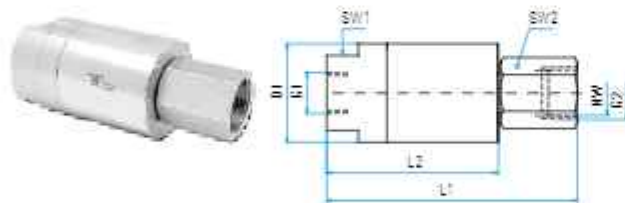

| Part No. | G1 (F)      | G2 (F)      | NW     | SW1  | SW2  | L1   | L2   | D1   | max. RPM | Weight |
|----------|-------------|-------------|--------|------|------|------|------|------|----------|--------|
| 34.212   | 1/2" NPTF   | 1/2" NPTF   | 1/2"   | 1.50 | 1.06 | 4.92 | 3.43 | 1.97 | 200      | 41 oz  |
| 34.312   | 3/4" NPTF   | 3/4" NPTF   | 3/4"   | 1.65 | 1.26 | 5.24 | 3.66 | 2.17 | 150      | 53 oz  |
| 34.412   | 1" NPTF     | 1" NPTF     | 1"     | 1.81 | 1.42 | 5.55 | 3.78 | 2.36 | 130      | 60 oz  |
| 34.542   | 1 1/4" NPTF | 1 1/4" NPTF | 1 1/4" | 2.00 | 1.73 | 5.55 | 3.98 | 2.36 | 130      | 61 oz  |
| 34.512   | 1 1/2" NPTF | 1 1/2" NPTF | 1 1/2" | 2.55 | 2.17 | 6.06 | 4.09 | 3.15 | 100      | 114 oz |
| 34.612   | 2" NPTF     | 2" NPTF     | 2"     | 2.95 | 2.56 | 6.70 | 4.57 | 3.54 | 70       | 133 oz |
| 34.647*  | 2 1/2" NPTF | 2 1/2" NPTF | 2 1/2" | 3.35 | 3.35 | 10.7 | 8.53 | 6.30 | 50       | 713 oz |

|        |                        |
|--------|------------------------|
| 34.911 | Seal kit for NW 1/2"   |
| 34.912 | Seal kit for NW 3/4"   |
| 34.913 | Seal kit for NW 1"     |
| 34.943 | Seal kit for NW 1 1/4" |
| 34.914 | Seal kit for NW 1 1/2" |
| 34.915 | Seal kit for NW 2"     |
| 34.950 | Seal kit for NW 2 1/2" |

|        |                          |
|--------|--------------------------|
| 34.920 | Repair kit for NW 1/2"   |
| 34.921 | Repair kit for NW 3/4"   |
| 34.922 | Repair kit for NW 1"     |
| 34.944 | Repair kit for NW 1 1/4" |
| 34.923 | Repair kit for NW 1 1/2" |
| 34.924 | Repair kit for NW 2"     |
| 34.951 | Repair kit for NW 2 1/2" |

Repair kit includes seal and bearing set.

Legend

M. = metric thrust, M = male, F = female, B = gas side thrust, R = gas side thrust control, QV = quick connects, SW = profiling fitting, D = diameter, L = length, NW = nominal width, SW = insertion size.

Additional Seal Options available

EPDM (E) or FKM/Viton (V). Please indicate letter of seal material after part number. Minimum orders apply.



- ✓ Stainless steel
- ✓ Maintenance free
- ✓ Sliding bearing

## Application

Ceiling boom, high pressure hose reels, high pressure cleaner, food industry

### TECHNICAL DATA

|                          |  |
|--------------------------|--|
| <b>Pressure</b>          | 4000 psi (27.5 MPa)  |
| <b>Temperature</b>       | 250°F  |
| <b>RPM</b>               | max. 30 rpm  |
| <b>Body</b>              | brass, nickel plated                                       |
| <b>Inner part</b>        | stainless steel  |
| <b>Seal</b>              | O-ring NBR / Support ring (optional EPDM or FKM)           |
| <b>Bearing</b>           | sliding bearing  |
| <b>Throughput medium</b> | pH 3-12<br>filtered 10 microns<br>compressed air (290 psi) |

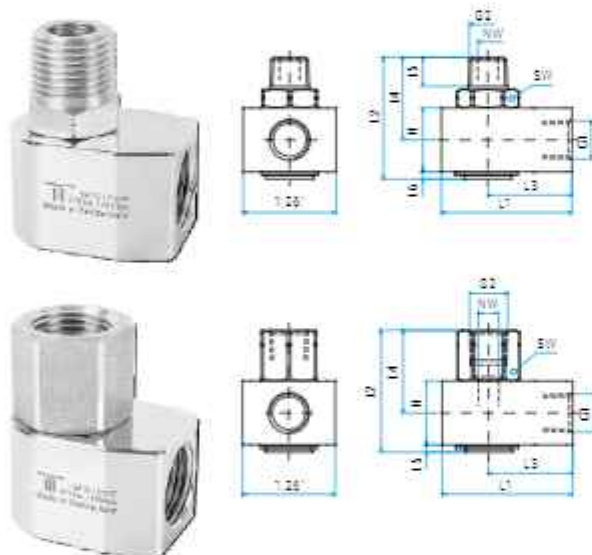
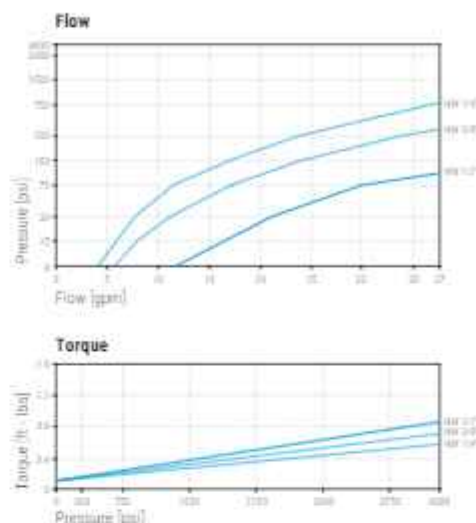

### WDE

| Part No. | G1 (F)    | G2 (M)    | NW   | H    | L1   | L2   | L3   | L4   | L5   | L6  | SW   | Weight |
|----------|-----------|-----------|------|------|------|------|------|------|------|-----|------|--------|
| 43.451   | 1/4" NPTF | 1/4" NPTM | 1/4" | 0.87 | 1.77 | 1.65 | 1.14 | 1.12 | 0.39 | 0.1 | 0.75 | 7.9 oz |
| 43.452   | 3/8" NPTF | 3/8" NPTM | 3/8" | 0.94 | 1.77 | 1.77 | 1.14 | 1.20 | 0.43 | 0.1 | 0.75 | 8.1 oz |
| 43.453   | 1/2" NPTF | 1/2" NPTM | 1/2" | 1.1  | 1.77 | 2.17 | 1.14 | 1.32 | 0.59 | 0.1 | 0.87 | 9.3 oz |
| 43.454   | 3/8" NPTF | 1/2" NPTM | 1/2" | 1.1  | 1.77 | 2.17 | 1.14 | 1.32 | 0.59 | 0.1 | 0.87 | 9.9 oz |

| Part No. | G1 (F)    | G2 (F)    | NW   | H    | L1   | L2   | L3   | L4   | L5  | SW   | Weight  |
|----------|-----------|-----------|------|------|------|------|------|------|-----|------|---------|
| 43.456   | 1/4" NPTF | 1/4" NPTF | 1/4" | 0.87 | 1.77 | 1.65 | 1.14 | 1.12 | 0.1 | 0.75 | 8.3 oz  |
| 43.457   | 3/8" NPTF | 3/8" NPTF | 3/8" | 0.94 | 1.77 | 1.77 | 1.14 | 1.20 | 0.1 | 0.75 | 7.9 oz  |
| 43.458   | 1/2" NPTF | 1/2" NPTF | 1/2" | 1.1  | 1.77 | 2.17 | 1.14 | 1.32 | 0.1 | 1.05 | 10.2 oz |
| 43.459   | 3/8" NPTF | 1/2" NPTF | 1/2" | 1.1  | 1.77 | 2.17 | 1.14 | 1.32 | 0.1 | 1.05 | 10.8 oz |

#### Legend

M. = metric thrust, ...M = male, F = female, B = gas side thrust, R = gas side thrust optional, QV = quick connects  
 SW = profiling fitting, D = diameter, L = length, NW = nominal width, SW = swivel size

#### Additional Seal Options available

EPDM (E) or FKM/Viton (V). Please indicate letter of seal material after part number. Minimum orders apply.

- ✓ Complete stainless steel
- ✓ Maintenance free
- ✓ Compact design
- ✓ Sliding bearing system



## Application

Hose reels

### TECHNICAL DATA

|                          |   |
|--------------------------|---|
| <b>Pressure</b>          | 5800 psi (40 MPa)<br>3000 psi (20 MPa)*<br>725 psi (5 MPa)    |
| <b>Temperature</b>       | 250°F   |
| <b>RPM</b>               | max. 30 rpm   |
| <b>Body</b>              | stainless steel   |
| <b>Inner part</b>        | stainless steel   |
| <b>Seal</b>              | O-ring NBR<br>(optional: EPDM or FKM)                         |
| <b>Bearing</b>           | sliding bearings  |
| <b>Throughput medium</b> | pH: 3 - 12<br>filtered 10 microns<br>compressed air (290 psi) |

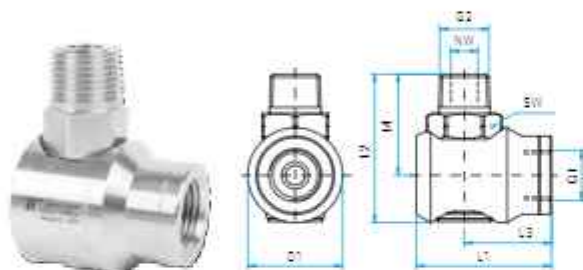
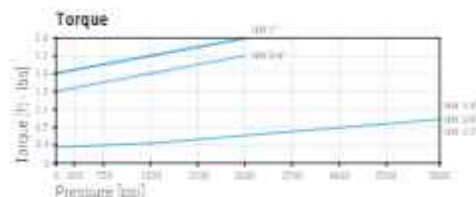
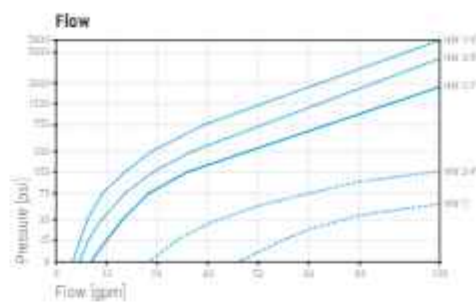

### WDEI (up to 5800 psi)

| Part No. | Box Part No. | G1 (F)    | G2 (M)    | NW   | L1   | L2   | L3   | L4   | D1   | SW   | Box    | Weight  |
|----------|--------------|-----------|-----------|------|------|------|------|------|------|------|--------|---------|
| 43.461   | 43.461B      | 1/4" NPTF | 1/4" NPTM | 1/4" | 1.77 | 2.13 | 1.14 | 1.50 | 1.25 | 0.87 | 25 pcs | 9.2 oz  |
| 43.462   | 43.462B      | 3/8" NPTF | 3/8" NPTM | 3/8" | 1.77 | 2.17 | 1.14 | 1.54 | 1.25 | 0.87 | 25 pcs | 8.7 oz  |
| 43.463   | 43.463B      | 1/2" NPTF | 1/2" NPTM | 1/2" | 1.97 | 2.60 | 1.34 | 1.81 | 1.37 | 0.97 | 25 pcs | 13.2 oz |
| 43.464*  | 43.464*      | 3/4" NPTF | 3/4" NPTM | 3/4" | 2.95 | 3.34 | 1.89 | 2.26 | 2.15 | 1.42 | 10 pcs | 27.5 oz |
| 43.465*  | 43.465*      | 1" NPTF   | 1" NPTM   | 1"   | 3.35 | 3.54 | 2.17 | 2.35 | 2.35 | 1.61 | 10 pcs | 37.7 oz |
| 43.466   | 43.466B      | 3/8" NPTF | 1/2" NPTM | 3/8" | 1.77 | 2.35 | 1.14 | 1.72 | 1.25 | 0.87 | 25 pcs | 9.5 oz  |
| 43.467   | 43.467B      | 1/2" NPTF | 3/8" NPTM | 1/2" | 1.97 | 2.44 | 1.34 | 1.55 | 1.37 | 0.87 | 25 pcs | 12.5 oz |

\* up to 3000 psi

### WDEI low Pressure (up to 725 psi)

| Part No. | Box Part No. | G1 (F)    | G2 (M)    | NW   | L1   | L2   | L3   | L4   | D1   | SW   | Box    | Weight  |
|----------|--------------|-----------|-----------|------|------|------|------|------|------|------|--------|---------|
| 43.481   | 43.481B      | 1/4" NPTF | 1/4" NPTM | 1/4" | 1.77 | 2.14 | 1.14 | 1.52 | 1.24 | 0.87 | 25 pcs | 8.5 oz  |
| 43.482   | 43.482B      | 3/8" NPTF | 3/8" NPTM | 3/8" | 1.77 | 2.18 | 1.14 | 1.55 | 1.24 | 0.87 | 25 pcs | 7.8 oz  |
| 43.483   | 43.483B      | 1/2" NPTF | 1/2" NPTM | 1/2" | 1.97 | 2.34 | 1.34 | 1.72 | 1.24 | 0.87 | 25 pcs | 7.8 oz  |
| 43.484   | 43.484B      | 3/4" NPTF | 3/4" NPTM | 3/4" | 2.95 | 3.15 | 1.89 | 2.13 | 2.00 | 1.42 | 10 pcs | 27.5 oz |
| 43.485   | 43.485B      | 1" NPTF   | 1" NPTM   | 1"   | 3.35 | 3.54 | 2.17 | 2.35 | 2.35 | 1.61 | 10 pcs | 37.7 oz |
| 43.486   | 43.486B      | 3/8" NPTF | 1/2" NPTM | 3/8" | 1.77 | 2.34 | 1.14 | 1.72 | 1.24 | 0.87 | 25 pcs | 7.8 oz  |
| 43.487   | 43.487B      | 1/2" NPTF | 3/8" NPTM | 1/2" | 1.97 | 2.18 | 1.34 | 1.55 | 1.24 | 0.87 | 25 pcs | 7.8 oz  |



### WDEI (up to 5800 psi)

| Part No. | Box Part No. | G1 (F)    | G2 (F)    | NW   | L1   | L2   | L3   | L4   | D1   | SW   | Box    | Weight  |
|----------|--------------|-----------|-----------|------|------|------|------|------|------|------|--------|---------|
| 43.471   | 43.471B      | 1/4" NPTF | 1/4" NPTF | 1/4" | 1.77 | 1.91 | 1.14 | 1.25 | 1.25 | 0.87 | 25 pcs | 9.3 oz  |
| 43.472   | 43.472B      | 3/8" NPTF | 3/8" NPTF | 3/8" | 1.77 | 1.91 | 1.14 | 1.25 | 1.25 | 0.87 | 25 pcs | 8.3 oz  |
| 43.473   | 43.473B      | 1/2" NPTF | 1/2" NPTF | 1/2" | 1.97 | 2.27 | 1.34 | 1.45 | 1.37 | 0.94 | 25 pcs | 12.2 oz |
| 43.474*  | 43.474*      | 3/4" NPTF | 3/4" NPTF | 3/4" | 2.95 | 2.95 | 1.89 | 1.97 | 2.15 | 1.42 | 10 pcs | 29.6 oz |
| 43.475*  | 43.475*      | 1" NPTF   | 1" NPTF   | 1"   | 3.35 | 3.07 | 2.17 | 1.89 | 2.35 | 1.61 | 10 pcs | 39.5 oz |

\* up to 3000 psi

### WDEI low Pressure (up to 725 psi)

| Part No. | Box Part No. | G1 (F)    | G2 (F)    | NW   | L1   | L2   | L3   | L4   | D1   | SW   | Box    | Weight  |
|----------|--------------|-----------|-----------|------|------|------|------|------|------|------|--------|---------|
| 43.491   | 43.491B      | 1/4" NPTF | 1/4" NPTF | 1/4" | 1.77 | 1.83 | 1.14 | 1.20 | 1.24 | 0.87 | 25 pcs | 8.8 oz  |
| 43.492   | 43.492B      | 3/8" NPTF | 3/8" NPTF | 3/8" | 1.77 | 1.85 | 1.14 | 1.24 | 1.24 | 0.87 | 25 pcs | 7.8 oz  |
| 43.493   | 43.493B      | 1/2" NPTF | 1/2" NPTF | 1/2" | 1.97 | 1.98 | 1.34 | 1.35 | 1.24 | 0.94 | 25 pcs | 7.0 oz  |
| 43.494   | 43.494B      | 3/4" NPTF | 3/4" NPTF | 3/4" | 2.95 | 2.74 | 1.89 | 1.73 | 2.03 | 1.42 | 10 pcs | 29.6 oz |
| 43.495   | 43.495B      | 1" NPTF   | 1" NPTF   | 1"   | 3.35 | 3.05 | 2.17 | 1.89 | 2.35 | 1.61 | 10 pcs | 39.5 oz |



Example of an OEM-box which includes 25 swivels.

|        |                       |        |                          |
|--------|-----------------------|--------|--------------------------|
| 43.922 | Seal kit NW 1/4"-1/2" | 43.934 | Seal kit LP NW 1/4"-1/2" |
| 43.930 | Seal kit NW 3/4"      | 43.935 | Seal kit LP NW 3/4"      |
| 43.931 | Seal kit NW 1"        | 43.936 | Seal kit LP NW 1"        |

#### Legend

M. = metric thrust, .M = male, F = female, B = gas pipe thrust, R = gas pipe thrust control, QV = quick connects  
 SW = profiling fitting, D = diameter, L = length, NW = nominal width, SW = insertion size

#### Additional Seal Options available

EPDM (E) or FKM/Viton (V). Please indicate letter of seal material after part number. Minimum orders apply.



- ✓ Compact design
- ✓ Stainless steel
- ✓ Maintenance free

### Application

Ceiling booms, high pressure hose reels, high pressure cleaners

### TECHNICAL DATA

|                          |  |
|--------------------------|--|
| <b>Pressure</b>          | 2200 psi (15 MPa)<br>4000 psi* (27.5 MPa)                  |
| <b>Temperature</b>       | 200°F / 250°F*   |
| <b>RPM</b>               | max. 30 rpm  |
| <b>Body</b>              | brass, nickel plated                                       |
| <b>Inner part</b>        | stainless steel  |
| <b>Seal</b>              | O-ring NBR / Support ring<br>(optional: EPDM or FKM)       |
| <b>Bearing</b>           | sliding bearing  |
| <b>Throughput medium</b> | pH 3-12<br>filtered 10 microns<br>compressed air (290 psi) |

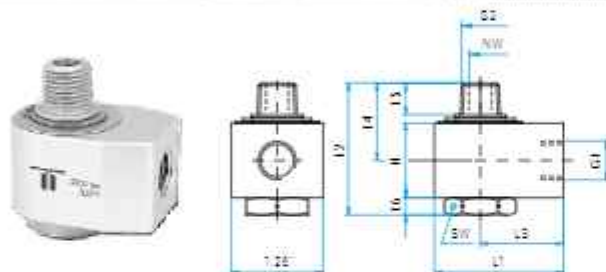
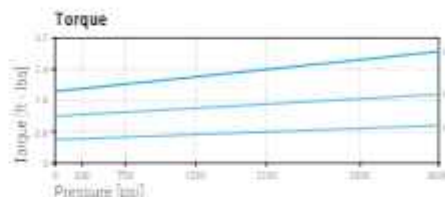
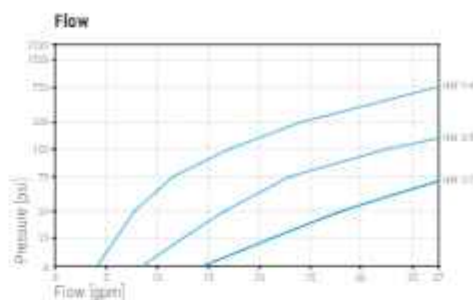

### WDG

| Part No. | G1 (F)    | G2 (M)    | NW   | H    | L1   | L2   | L3   | L4   | L5   | L6   | SW   | Weight  |
|----------|-----------|-----------|------|------|------|------|------|------|------|------|------|---------|
| 40.009*  | G1/4" F   | G3/4" M   | 1/4" | 1.02 | 1.77 | 1.73 | 1.14 | 0.95 | 0.33 | 0.25 | 0.87 | 9.8 oz  |
| 40.019*  | 3/8" NPTF | G1/4" M   | 1/4" | 1.02 | 1.77 | 1.73 | 1.14 | 0.95 | 0.43 | 0.25 | 0.87 | 9.7 oz  |
| 40.021   | 1/4" NPTF | 1/4" NPTM | 1/4" | 1.02 | 1.77 | 1.89 | 1.14 | 1.14 | 0.47 | 0.24 | 0.87 | 10.3 oz |
| 40.022   | 1/4" NPTF | 3/8" NPTM | 1/4" | 1.02 | 1.77 | 1.89 | 1.14 | 1.14 | 0.47 | 0.24 | 0.87 | 10.3 oz |
| 40.031   | 3/8" NPTF | 1/4" NPTM | 1/4" | 1.02 | 1.77 | 1.89 | 1.14 | 1.14 | 0.47 | 0.24 | 0.87 | 9.6 oz  |
| 40.032   | 3/8" NPTF | 3/8" NPTM | 1/4" | 1.02 | 1.77 | 1.89 | 1.14 | 1.14 | 0.47 | 0.24 | 0.87 | 10.0 oz |

\* 4000 psi / 250°F / without snap ring, for Mosmatic ceiling boom

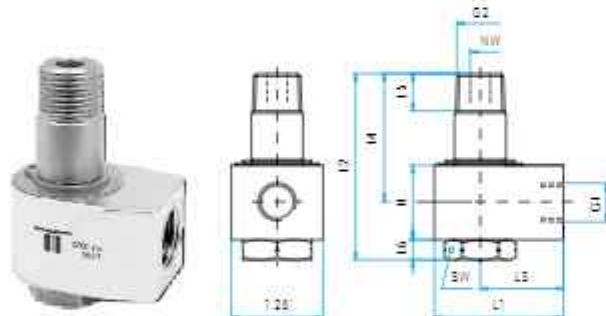

| Part No. | G1 (F)    | G2 (M)    | NW   | H    | L1   | L2   | L3   | L4   | L5   | L6   | SW   | Weight  |
|----------|-----------|-----------|------|------|------|------|------|------|------|------|------|---------|
| 40.028   | 1/4" NPTF | 1/4" NPTM | 1/4" | 1.02 | 1.77 | 2.55 | 1.14 | 1.77 | 0.47 | 0.27 | 0.87 | 10.0 oz |
| 40.029   | 1/4" NPTF | 3/8" NPTM | 1/4" | 1.02 | 1.77 | 2.55 | 1.14 | 1.77 | 0.51 | 0.27 | 0.87 | 11.7 oz |
| 40.039   | 3/8" NPTF | 3/8" NPTM | 1/4" | 1.28 | 1.77 | 2.09 | 1.14 | 1.18 | 0.43 | 0.28 | 0.94 | 11.4 oz |

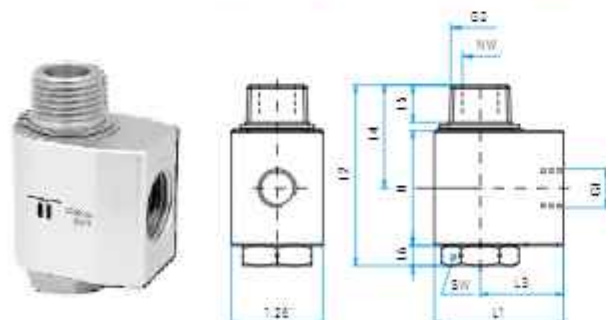

| Part No. | G1 (F)    | G2 (M)    | NW   | H    | L1   | L2   | L3   | L4   | L5   | L6   | SW   | Weight  |
|----------|-----------|-----------|------|------|------|------|------|------|------|------|------|---------|
| 40.211   | G1/2" F   | R1/2" M   | 1/2" | 1.57 | 1.77 | 2.48 | 1.14 | 1.42 | 0.43 | 0.28 | 0.94 | 13.5 oz |
| 40.231   | 1/2" NPTF | 1/2" NPTM | 1/2" | 1.57 | 1.77 | 2.48 | 1.14 | 1.42 | 0.43 | 0.28 | 0.94 | 13.5 oz |

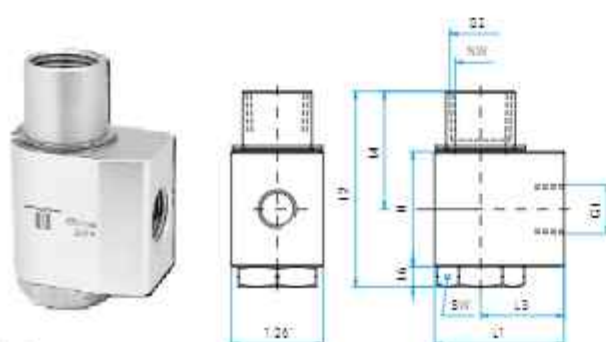

| Part No. | G1 (F)    | G2 (F)    | NW   | H    | L1   | L2   | L3   | L4   | L5   | L6   | SW      | Weight |
|----------|-----------|-----------|------|------|------|------|------|------|------|------|---------|--------|
| 40.223   | 3/8" NPTF | 1/2" NPTF | 1/2" | 1.57 | 1.77 | 2.75 | 1.14 | 1.89 | 0.28 | 1.06 | 14.1 oz |        |

|        |                             |
|--------|-----------------------------|
| 40.502 | Seal kit for NW 1/4"        |
| 40.503 | Seal kit for NW 3/8" + 1/2" |

### Legend

M. = metric thrust, .M = male, F = female, B = gas side thrust, R = gas side thrust optional, QV = quick connects  
 SW = profiling fitting, D = diameter, L = length, NW = nominal width, SW = swivel size

### Additional Seal Options available

EPDM (E) or FKM/Viton (V). Please indicate letter of seal material after part number.  
 Minimum orders apply.



- ✓ Slide or dual bearing systems
- ✓ Stainless steel
- ✓ Maintenance free

## Application

Ceiling boom, high pressure hose reels, high pressure cleaner

### TECHNICAL DATA

|                          |  |
|--------------------------|--|
| <b>Pressure</b>          | 4000 psi (27.5 MPa)  |
| <b>Temperature</b>       | 250°F  |
| <b>RPM</b>               | see chart (max. RPM)   |
| <b>Body</b>              | brass, nickel plated   |
| <b>Inner part</b>        | stainless steel  |
| <b>Seal</b>              | O-ring NBR<br>(optional EPDM or FKM)   |
| <b>Bearing</b>           | WDB: sliding bearing<br>WDBL: 2x radial ball bearings<br>WDBS: 2x radial ball bearings |
| <b>Throughput medium</b> | pH 3 - 12<br>filtered 10 microns<br>compressed air (290 psi)                           |

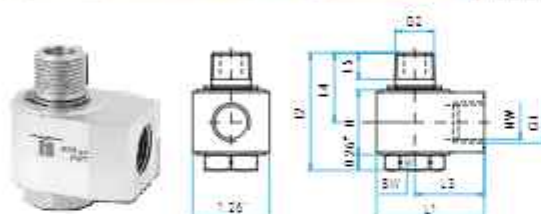
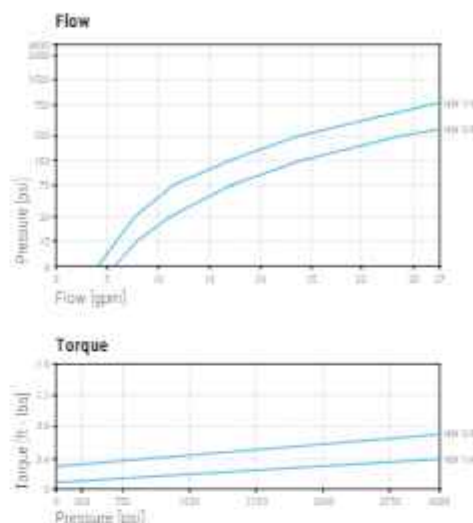

### WDB

| Part No. | G1 (F)    | G2 (M)    | NW   | H    | L1   | L2   | L3   | L4   | L5   | SW   | max. RPM | Weight  |
|----------|-----------|-----------|------|------|------|------|------|------|------|------|----------|---------|
| 43.251   | 1/4" NPTF | 1/4" NPTM | 1/4" | 1.05 | 1.77 | 1.89 | 1.14 | 1.10 | 0.39 | 0.87 | 30       | 10.0 oz |
| 43.252   | 3/8" NPTF | 3/8" NPTM | 3/8" | 1.05 | 1.77 | 1.93 | 1.14 | 1.14 | 0.43 | 0.87 | 30       | 9.2 oz  |
| 43.259*  | 3/8" NPTF | G1/4" M   | 1/4" | 1.05 | 1.77 | 1.77 | 1.14 | 0.98 | 0.43 | 0.87 | 30       | 9.6 oz  |
| 43.905   | 1/8" NPTF | 1/8" NPTF | 1/4" | 1.05 | 1.77 | 0.87 | 1.14 | 0.62 | -    | 0.87 | 30       | 10.0 oz |

\* without snap ring, for Mosmatic ceiling boom

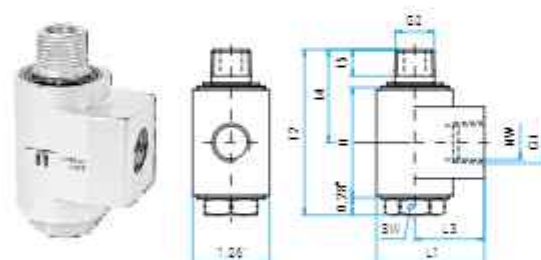

### WDBL (with radial ball bearings)

| Part No. | G1 (F)    | G2 (M)    | NW   | H    | L1   | L2   | L3   | L4   | L5   | SW   | max. RPM | Weight  |
|----------|-----------|-----------|------|------|------|------|------|------|------|------|----------|---------|
| 43.262   | 3/8" NPTF | 3/8" NPTM | 3/8" | 1.81 | 1.77 | 2.72 | 1.14 | 1.53 | 0.43 | 0.87 | 200      | 15.7 oz |

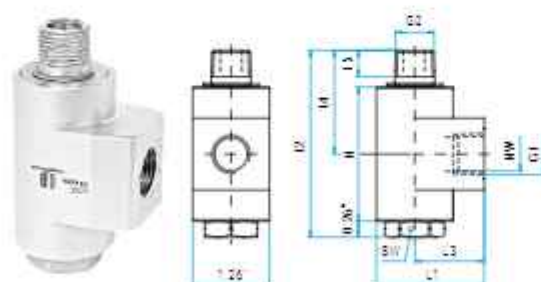

### WDBS (with radial ball bearings and protection plate)

| Part No. | G1 (F)    | G2 (M)    | NW   | H    | L1   | L2   | L3   | L4   | L5   | SW   | max. RPM | Weight  |
|----------|-----------|-----------|------|------|------|------|------|------|------|------|----------|---------|
| 43.272   | 3/8" NPTF | 3/8" NPTM | 3/8" | 2.20 | 1.77 | 3.07 | 1.14 | 1.70 | 0.43 | 0.87 | 200      | 18.5 oz |

|        |          |
|--------|----------|
| 43.904 | Seal kit |
|--------|----------|

#### Legend

M. = metric thread, ...M = male, F = female, B = gas side thrust, R = gas side thrust control, QV = quick connects  
 SW = profiling fitting, D = diameter, L = length, NW = nominal width, SW = hexagon size

#### Additional Seal Options available

EPDM (E) or FKM/Viton (V). Please indicate letter of seal material after part number. Minimum orders apply.

- ✓ Slide or dual bearing systems
- ✓ Stainless steel
- ✓ Maintenance free

### Application

High pressure hose reels, ceiling booms, high pressure cleaners

#### TECHNICAL DATA

**Pressure** 4000 psi (27.5 MPa)  
**Temperature** 250°F  
**RPM** see chart (max. RPM)  
**Body** brass, nickel plated  
**Inner part** stainless steel  
**Seal** O-ring NBR  
 (optional: EPDM or FKM)  
**Bearing** WDC: sliding bearing  
 WDCL: 2x radial ball bearings  
 WDCL: 2x radial ball bearings  
**Throughput medium** pH 9 - 12  
 filtered 10 microns  
 compressed air (290 psi)

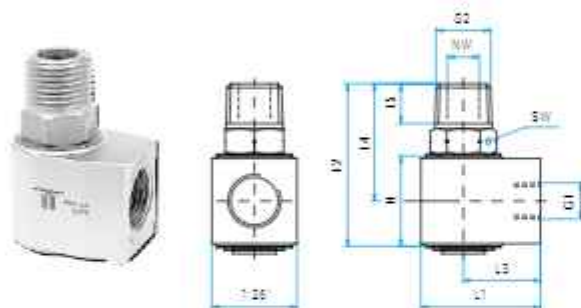
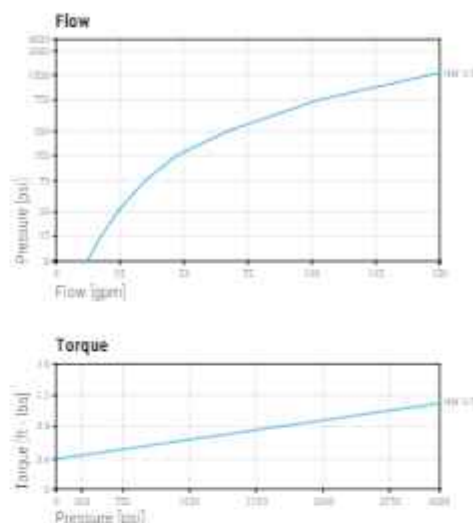

#### WDC

| Part No. | G1 (F)    | G2        | NW   | H    | L1   | L2   | L3   | L4   | L5   | SW   | max. RPM | Weight  |
|----------|-----------|-----------|------|------|------|------|------|------|------|------|----------|---------|
| 43.353   | 1/2" NPTF | 1/2" NPTM | 1/2" | 1.94 | 1.77 | 2.40 | 1.14 | 1.73 | 0.59 | 0.87 | 30       | 11.5 oz |
| 43.354   | 1/2" NPTF | 1/2" NPTF | 1/2" | 1.94 | 1.77 | 2.40 | 1.14 | 1.73 | 0.59 | 0.87 | 30       | 11.7 oz |

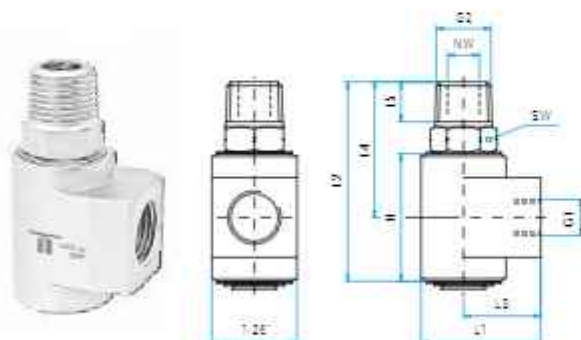

#### WDCL (with radial ball bearings)

| Part No. | G1 (F)    | G2        | NW   | H    | L1   | L2   | L3   | L4   | L5   | SW   | max. RPM | Weight  |
|----------|-----------|-----------|------|------|------|------|------|------|------|------|----------|---------|
| 43.363   | 1/2" NPTF | 1/2" NPTM | 1/2" | 1.81 | 1.77 | 2.87 | 1.14 | 1.97 | 0.59 | 0.87 | 200      | 15.3 oz |
| 43.364   | 1/2" NPTF | 1/2" NPTF | 1/2" | 1.81 | 1.77 | 2.87 | 1.14 | 1.97 | 0.59 | 1.06 | 200      | 15.5 oz |
| 43.902   | 3/8" NPTF | 1/4" NPTF | 3/8" | 1.81 | 1.77 | 2.48 | 1.14 | 1.57 | 0.47 | 0.87 | 200      | 14.6 oz |
| 43.932   | 1/2" NPTF | 3/8" NPTF | 1/2" | 1.81 | 1.77 | 2.64 | 1.14 | 1.73 | 0.51 | 0.87 | 200      | 14.4 oz |

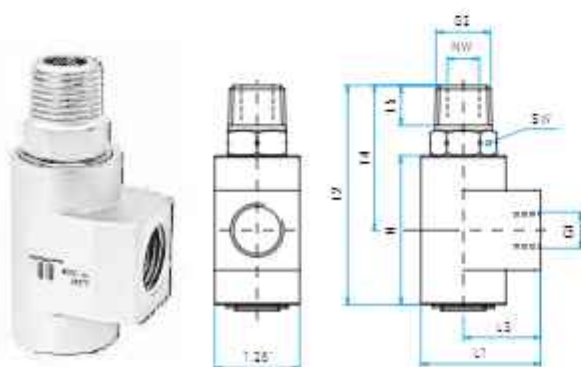

#### WDCL (with radial ball bearings and protection plate)

| Part No. | G1 (F)    | G2        | NW   | H    | L1   | L2   | L3   | L4   | L5   | SW   | max. RPM | Weight  |
|----------|-----------|-----------|------|------|------|------|------|------|------|------|----------|---------|
| 43.373   | 1/2" NPTF | 1/2" NPTM | 1/2" | 2.20 | 1.77 | 3.24 | 1.14 | 2.15 | 0.59 | 0.87 | 200      | 16.0 oz |
| 43.374   | 1/2" NPTF | 1/2" NPTF | 1/2" | 2.20 | 1.77 | 3.24 | 1.14 | 2.15 | 0.59 | 0.87 | 200      | 16.2 oz |

|        |          |
|--------|----------|
| 43.904 | Seal kit |
|--------|----------|

#### Legend

M. = metric thrust, ...M = male, F = female, B = gas pipe thrust, R = gas pipe thrust optional, QV = quick connects  
 SW = profiling fitting, D = diameter, L = length, NW = nominal width, SW = swivel size

#### Additional Seal Options available

EPDM (E) or FKM/Viton (V). Please indicate letter of seal material after part number.  
 Minimum orders apply.

- ✓ Dual bearing system
- ✓ Complete stainless steel construction
- ✓ Rugged design
- ✓ Maintenance free

### Application

Automatic car wash, Industrial application, high pressure hose reels, high flow



#### TECHNICAL DATA

|                          |  |
|--------------------------|--|
| <b>Pressure</b>          | 150-3000 psi (1-20 MPa)<br>290 psi* (2 MPa)                |
| <b>Temperature</b>       | 40°F - 180°F   |
| <b>RPM</b>               | see chart (max. RPM)                                       |
| <b>Body</b>              | stainless steel  |
| <b>Inner part</b>        | stainless steel  |
| <b>Seal</b>              | O-ring NBR<br>(optional: EPDM or FKM)                      |
| <b>Bearing</b>           | 2x radial ball bearings                                    |
| <b>Throughput medium</b> | pH 3-12<br>filtered 10 microns<br>compressed air (290 psi) |

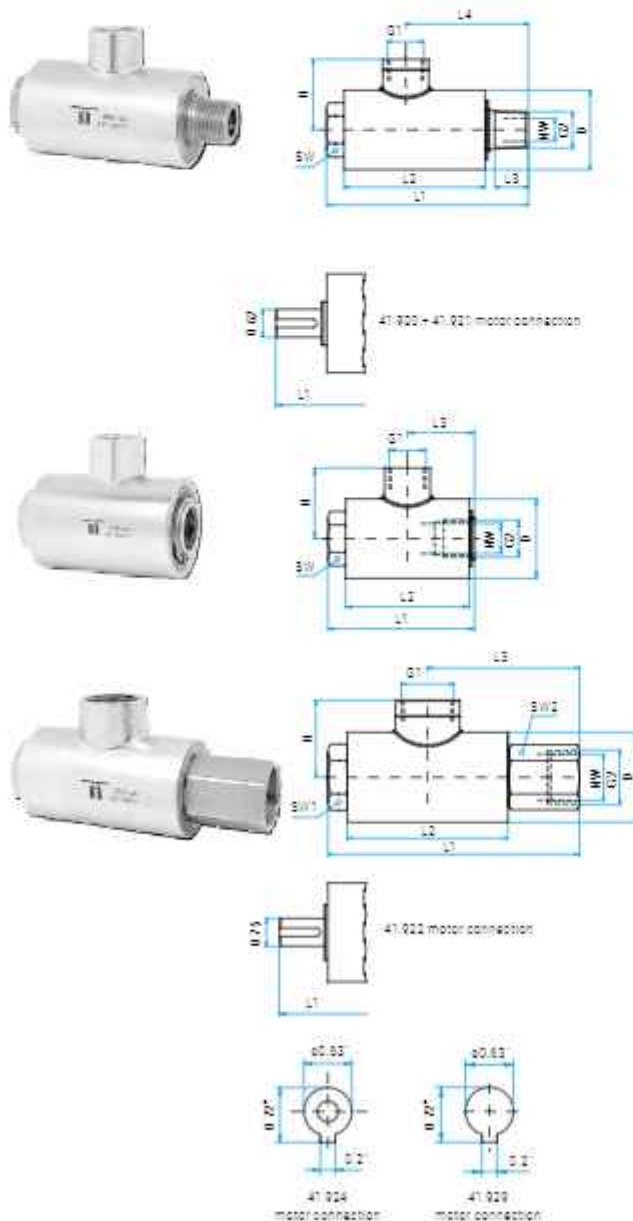
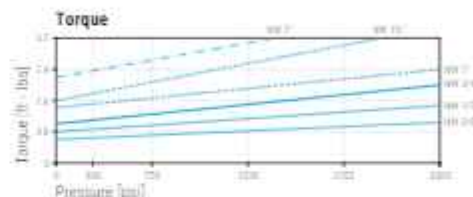
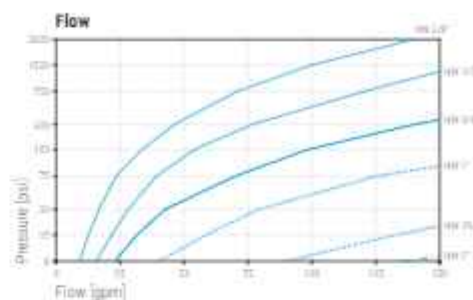

#### WDRS (no front to back forces allowed)

| Part No. | G1 (F)      | G2 (M)      | NW     | SW   | H    | L1   | L2   | L3   | L4   | D    | max. RPM | Weight |
|----------|-------------|-------------|--------|------|------|------|------|------|------|------|----------|--------|
| 41.161   | 3/8" NPTF   | 3/8" NPTM   | 3/8"   | 1.06 | 1.46 | 4.13 | 3.15 | 0.43 | 2.20 | 1.77 | 150      | 33 oz  |
| 41.261   | 1/2" NPTF   | 1/2" NPTM   | 1/2"   | 1.06 | 1.57 | 4.33 | 3.15 | 0.60 | 2.36 | 1.77 | 150      | 33 oz  |
| 41.361   | 3/4" NPTF   | 3/4" NPTM   | 3/4"   | 1.26 | 1.69 | 4.80 | 3.54 | 0.63 | 2.64 | 1.97 | 130      | 41 oz  |
| 41.461   | 1" NPTF     | 1" NPTM     | 1"     | 1.42 | 1.89 | 5.35 | 3.94 | 0.71 | 2.91 | 2.20 | 110      | 56 oz  |
| 41.561   | 1 1/2" NPTF | 1 1/2" NPTM | 1 1/2" | 2.17 | 2.36 | 5.91 | 4.33 | 0.79 | 3.27 | 2.80 | 76       | 99 oz  |
| 41.661   | 2" NPTF     | 2" NPTM     | 2"     | 2.76 | 2.76 | 7.09 | 5.28 | 0.87 | 3.82 | 3.54 | 60       | 173 oz |
| 41.646*  | 2 1/2" NPTF | 2 1/2" NPTM | 2 1/2" | 3.35 | 3.94 | 9.90 | 6.89 | 1.14 | 5.63 | 5.51 | 50       | 528 oz |

#### WDRS (with motor connection)

| Part No. | G1 (F)    | G2 (M)    | NW   | SW   | H    | L1   | L2   | L3   | L4   | D    | max. RPM | Weight |
|----------|-----------|-----------|------|------|------|------|------|------|------|------|----------|--------|
| 41.920   | 1/2" NPTF | 1/2" NPTM | 1/2" | 1.06 | 1.57 | 6.10 | 2.76 | 0.60 | 3.31 | 1.77 | 150      | 33 oz  |
| 41.921   | 1/2" NPTF | 1/2" NPTM | 1/2" | 0.75 | 1.57 | 6.10 | 3.15 | 0.60 | 3.31 | 1.77 | 150      | 36 oz  |

#### WDRS (no front to back forces allowed)

| Part No. | G1 (F)    | G2 (F)    | NW   | SW   | H    | L1   | L2   | L3   | D    | max. RPM | Weight |
|----------|-----------|-----------|------|------|------|------|------|------|------|----------|--------|
| 41.162   | 3/8" NPTF | 3/8" NPTF | 3/8" | 1.06 | 1.46 | 3.62 | 3.15 | 1.69 | 1.77 | 150      | 28 oz  |
| 41.262   | 1/2" NPTF | 1/2" NPTF | 1/2" | 1.06 | 1.57 | 3.62 | 3.15 | 1.69 | 1.77 | 150      | 28 oz  |

#### WDRS (no front to back forces allowed)

| Part No. | G1 (F)      | G2 (F)      | NW     | SW1  | SW2  | H    | L1   | L2   | L3   | D    | max. RPM | Weight |
|----------|-------------|-------------|--------|------|------|------|------|------|------|------|----------|--------|
| 41.362   | 3/4" NPTF   | 3/4" NPTF   | 3/4"   | 1.26 | 1.26 | 1.69 | 5.51 | 3.54 | 3.35 | 1.97 | 130      | 36 oz  |
| 41.462   | 1" NPTF     | 1" NPTF     | 1"     | 1.42 | 1.42 | 1.89 | 6.16 | 3.94 | 3.72 | 2.20 | 110      | 57 oz  |
| 41.562   | 1 1/2" NPTF | 1 1/2" NPTF | 1 1/2" | 2.17 | 2.17 | 2.36 | 6.77 | 4.33 | 3.90 | 2.80 | 76       | 101 oz |
| 41.662   | 2" NPTF     | 2" NPTF     | 2"     | 2.76 | 2.76 | 2.76 | 7.99 | 5.28 | 4.10 | 3.54 | 60       | 190 oz |
| 41.647*  | 2 1/2" NPTF | 2 1/2" NPTF | 2 1/2" | 3.35 | 3.35 | 3.94 | 9.70 | 6.89 | 5.63 | 5.51 | 50       | 528 oz |

#### WDRS (with motor connection)

| Part No. | G1 (F)    | G2 (F)    | NW   | SW2  | H    | L1   | L2   | L3   | D    | max. RPM | Weight |
|----------|-----------|-----------|------|------|------|------|------|------|------|----------|--------|
| 41.922   | 3/4" NPTF | 3/4" NPTF | 3/4" | 1.26 | 1.69 | 6.39 | 3.54 | 3.06 | 1.97 | 130      | 45 oz  |

#### WDRS (with motor connection, 1x radial ball bearings)

| Part No. | IN      | OUT                       | NW   | max. RPM | Weight |
|----------|---------|---------------------------|------|----------|--------|
| 40.924   | G3/8" F | 3x G1/4" F                | 3/8" | 130      | 106 oz |
| 40.929   | G3/8" F | 2x 1/8" NPTF / 1x G1/4" F | 3/8" | 130      | 113 oz |

|        |                        |        |                               |
|--------|------------------------|--------|-------------------------------|
| 41.911 | Seal kit for NW 3/8"   | 41.930 | Repair kit for NW 3/8" + 1/2" |
| 41.912 | Seal kit for NW 1/2"   | 41.931 | Repair kit for NW 3/4"        |
| 41.913 | Seal kit for NW 3/4"   | 41.932 | Repair kit for NW 1"          |
| 41.914 | Seal kit for NW 1"     | 41.933 | Repair kit for NW 1 1/2"      |
| 41.915 | Seal kit for NW 1 1/2" | 41.934 | Repair kit for NW 2"          |
| 41.916 | Seal kit for NW 2"     | 41.936 | Repair kit for NW 2 1/2"      |
| 41.925 | Seal kit for NW 2 1/2" |        |                               |

Repair kit includes seal and bearing set.

#### Legend

M. = metric thrust, ...M = male, F = female, B = gas pipe thrust, R = gas pipe thrust control, QV = quick connects  
 SW = profiling fitting, D = diameter, L = length, NW = nominal width, SW = insertion size.

#### Additional Seal Options available

EPDM (E) or FKM/Viton (V). Please indicate letter of seal material after part number. Minimum orders apply.



- ✓ High speed triple bearing system
- ✓ Corrosion resistant
- ✓ Solid construction
- ✓ Long service life
- ✓ Maintenance free



## Application

Thrust and radial forces, high flow, automatic car wash systems, high pressure hose reels

### TECHNICAL DATA

|                          |  |
|--------------------------|--|
| <b>Pressure</b>          | 4000 psi (27.5 MPa)  |
| <b>Temperature</b>       | 90°F (at 1'000 rpm)<br>250°F (at 30 rpm)                   |
| <b>RPM</b>               | max. 1'000 rpm   |
| <b>Body</b>              | DGL: brass, nickel plated<br>DGLI: stainless steel         |
| <b>Inner part</b>        | stainless steel  |
| <b>Seal</b>              | O-ring NBR<br>(optional: EPDM or FKM)                      |
| <b>Bearing</b>           | 2x radial ball bearings<br>1x thrust ball bearing          |
| <b>Throughput medium</b> | pH 3-12<br>filtered 10 microns<br>compressed air (290 psi) |

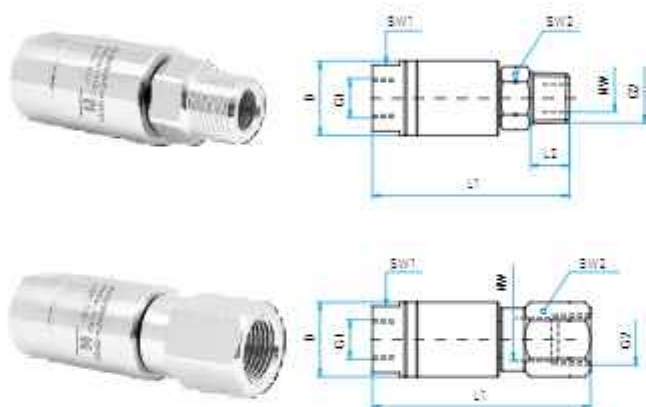
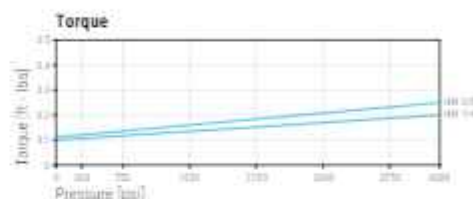
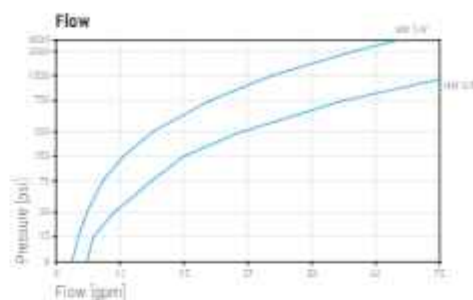

| DGL    |        | DGLI      |           | G1 (F) | G2 (M) | NW   | SW1  | SW2  | L1   | L2  | D  | Weight |
|--------|--------|-----------|-----------|--------|--------|------|------|------|------|-----|----|--------|
| 31.051 | 31.945 | 1/4" NPTF | 1/4" NPTM | 1/4"   | 0.67   | 0.67 | 2.55 | 0.43 | 0.98 | 5.7 | oz |        |
| 31.053 | 31.947 | 1/4" NPTF | 3/8" NPTM | 1/4"   | 0.67   | 0.75 | 2.59 | 0.47 | 0.98 | 5.7 | oz |        |
| 31.080 | ---    | 1/4" NPTF | 1/8" NPTM | 1/4"   | 0.67   | 0.39 | 2.24 | 0.31 | 0.98 | 5.3 | oz |        |
| 31.153 | 31.902 | 3/8" NPTF | 3/8" NPTM | 1/4"   | 0.67   | 0.75 | 2.59 | 0.47 | 0.98 | 5.8 | oz |        |
| 31.163 | 31.943 | 3/8" NPTF | G3/8" M   | 1/4"   | 0.67   | 0.75 | 2.59 | 0.47 | 0.98 | 5.7 | oz |        |
| 31.180 | ---    | 3/8" NPTF | 1/8" NPTM | 1/4"   | 0.67   | 0.39 | 2.24 | 0.31 | 0.98 | 4.9 | oz |        |
| 31.653 | 31.949 | 3/8" NPTF | 3/8" NPTM | 3/8"   | 0.67   | 0.75 | 2.63 | 0.47 | 0.98 | 5.8 | oz |        |

| Part No. | Part No. | G1 (F)    | G2 (F)    | NW   | SW1  | SW2  | L1   | D    | Weight |    |
|----------|----------|-----------|-----------|------|------|------|------|------|--------|----|
| 31.052   | 31.946   | 1/4" NPTF | 1/4" NPTF | 1/4" | 0.67 | 0.75 | 2.75 | 0.98 | 6.4    | oz |
| 31.054   | 31.948   | 1/4" NPTF | 3/8" NPTF | 1/4" | 0.67 | 0.67 | 2.87 | 0.98 | 6.8    | oz |
| 31.154   | 31.942   | 3/8" NPTF | 3/8" NPTF | 1/4" | 0.67 | 0.67 | 2.87 | 0.98 | 6.5    | oz |
| 31.654   | 31.951   | 3/8" NPTF | 3/8" NPTF | 3/8" | 0.67 | 0.67 | 2.87 | 0.98 | 6.5    | oz |

|        |                      |
|--------|----------------------|
| 33.910 | Seal kit for NW 1/4" |
|--------|----------------------|

#### Legend

M. = metric thrust, ...M = male, F = female, B = gas side thrust, R = gas side thrust optional, QV = quick connects  
 SW = profiling fitting, D = diameter, L = length, NW = nominal width, SW = swivel size

#### Additional Seal Options available

EPDM (E) or FKM/Viton (V). Please indicate letter of seal material after part number.  
 Minimum orders apply.

- ✓ High speed, triple bearing system
- ✓ Bulkhead fitting for mounting
- ✓ Corrosion resistant
- ✓ Highest quality and precision
- ✓ Maintenance free

### Application

High pressure cleaning technology, parts washers, tire cleaners, self rotating applications



#### TECHNICAL DATA

|                          |  |
|--------------------------|--|
| <b>Pressure</b>          | 4000 psi (27.5 MPa)  |
| <b>Temperature</b>       | 90°F (at 1'000 rpm)<br>250°F (at 30 rpm)                   |
| <b>RPM</b>               | max. 1'000 rpm   |
| <b>Body</b>              | DGG: brass, nickel plated<br>DGGI: stainless steel         |
| <b>Inner part</b>        | stainless steel  |
| <b>Seal</b>              | O-ring NBR<br>(optional: EPDM or FKM)                      |
| <b>Bearing</b>           | 2x radial ball bearings<br>1x thrust ball bearing          |
| <b>Throughput medium</b> | pH 3-12<br>filtered 10 microns<br>compressed air (290 psi) |

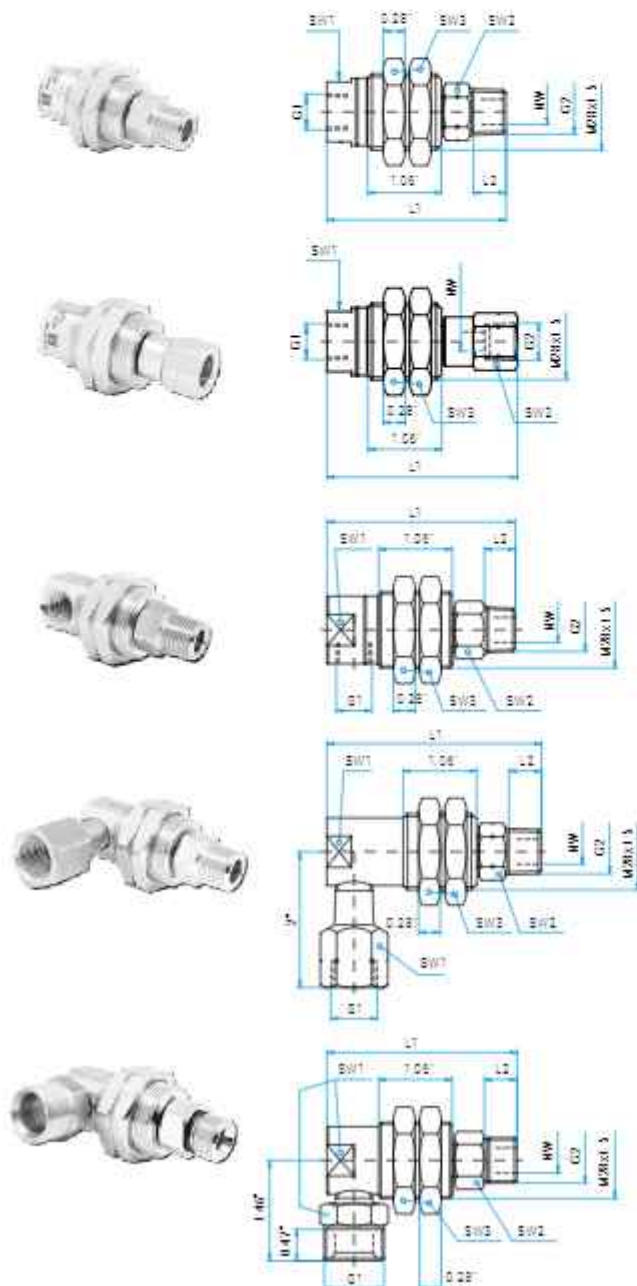
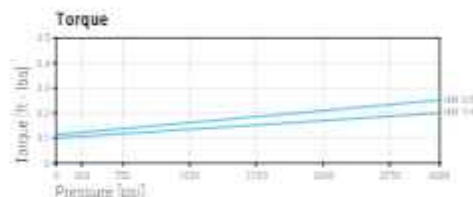
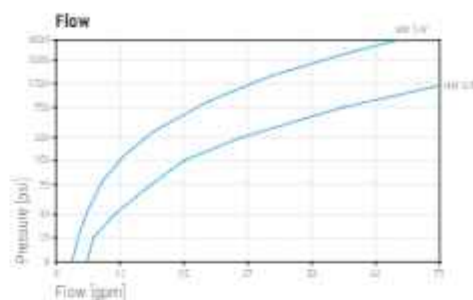

#### DGG DGGI

| Part No. | Part No. | G1 (F)    | G2 (M)    | NW   | SW1  | SW2  | SW3   | L1   | L2   | Weight |
|----------|----------|-----------|-----------|------|------|------|-------|------|------|--------|
| 33.051   | 33.924   | 1/4" NPTF | 1/4" NPTM | 1/4" | 0.87 | 0.67 | 1.34* | 2.71 | 0.43 | 8.5 oz |
| 33.053   | 33.925   | 1/4" NPTF | 3/8" NPTM | 1/4" | 0.87 | 0.75 | 1.34* | 2.75 | 0.47 | 7.4 oz |
| 33.063   | 33.907   | 1/4" NPTF | G3/8" M   | 1/4" | 0.87 | 0.75 | 1.34* | 2.59 | 0.39 | 8.7 oz |
| 33.080   | ---      | 1/4" NPTF | 1/8" NPTM | 1/4" | 0.87 | 0.39 | 1.34  | 2.24 | 0.31 | 7.0 oz |
| 33.151   | 33.927   | 3/8" NPTF | 1/4" NPTM | 1/4" | 0.87 | 0.67 | 1.34* | 2.55 | 0.43 | 7.4 oz |
| 33.153   | 33.928   | 3/8" NPTF | 3/8" NPTM | 1/4" | 0.87 | 0.75 | 1.34* | 2.59 | 0.47 | 8.5 oz |
| 33.163   | 33.929   | 3/8" NPTF | G3/8" M   | 1/4" | 0.87 | 0.75 | 1.34* | 2.59 | 0.39 | 8.4 oz |
| 33.180   | ---      | 3/8" NPTF | 1/8" NPTM | 1/4" | 0.87 | 0.39 | 1.34  | 2.24 | 0.31 | 6.7 oz |
| 33.653   | 33.930   | 3/8" NPTF | 3/8" NPTM | 3/8" | 0.87 | 0.75 | 1.34* | 2.63 | 0.47 | 7.6 oz |

\* at 2000 1/42

| Part No. | G1 (F)    | G2 (F)    | NW   | SW1  | SW2  | SW3  | L1   | Weight |
|----------|-----------|-----------|------|------|------|------|------|--------|
| 33.052   | 1/4" NPTF | 1/4" NPTF | 1/4" | 0.87 | 0.75 | 1.34 | 2.75 | 7.4 oz |
| 33.054   | 1/4" NPTF | 3/8" NPTF | 1/4" | 0.87 | 0.67 | 1.34 | 2.67 | 8.5 oz |
| 33.152   | 3/8" NPTF | 1/4" NPTF | 1/4" | 0.87 | 0.75 | 1.34 | 2.75 | 8.7 oz |
| 33.154   | 3/8" NPTF | 3/8" NPTF | 1/4" | 0.87 | 0.67 | 1.34 | 2.67 | 8.8 oz |

#### DGG 90°

| Part No. | G1 (F)    | G2 (M)    | NW   | SW1  | SW2  | SW3  | L1   | L2   | Weight |
|----------|-----------|-----------|------|------|------|------|------|------|--------|
| 33.351   | 1/4" NPTF | 1/4" NPTM | 1/4" | 0.87 | 0.67 | 1.34 | 2.71 | 0.43 | 7.8 oz |
| 33.353   | 1/4" NPTF | 3/8" NPTM | 1/4" | 0.87 | 0.75 | 1.34 | 2.75 | 0.47 | 8.3 oz |

| Part No. | G1 (F)    | G2 (M)    | NW   | SW1  | SW2  | SW3  | L1   | L2   | Weight  |
|----------|-----------|-----------|------|------|------|------|------|------|---------|
| 33.453   | 3/8" NPTF | 3/8" NPTM | 1/4" | 0.87 | 0.75 | 1.34 | 2.75 | 0.47 | 10.7 oz |
| 33.463   | 3/8" NPTF | G3/8" M   | 1/4" | 0.87 | 0.75 | 1.34 | 2.75 | 0.39 | 12.1 oz |

| Part No. | G1 (QV)   | G2 (M)  | NW   | SW1  | SW2  | SW3  | L1   | L2   | Weight  |
|----------|-----------|---------|------|------|------|------|------|------|---------|
| 33.503   | M21x1.5 M | G3/8" M | 1/4" | 0.87 | 0.75 | 1.34 | 2.75 | 0.47 | 10.4 oz |
| 33.553   | M22x1.5 M | G3/8" M | 1/4" | 0.87 | 0.75 | 1.34 | 2.75 | 0.47 | 11.7 oz |

|        |                      |
|--------|----------------------|
| 33.910 | Seal kit for NW 1/4" |
|--------|----------------------|

#### Legend

M. = metric thrust, M = male, F = female, B = gas pipe thrust, R = gas pipe thrust control, QV = quick connects  
 SW = profiling fitting, B = diameter, L = length, NW = nominal width, SW = insertion size

#### Additional Seal Options available

EPDM (E) or FKM/Viton (V). Please indicate letter of seal material after part number. Minimum orders apply.



- ✓ High speed, triple bearing system
- ✓ Body design for easy installation
- ✓ Maintenance free
- ✓ Highest precision and quality



### Application

High pressure cleaning technology, parts washers, tire cleaners, self rotating applications

### TECHNICAL DATA

|                          |  |
|--------------------------|--|
| <b>Pressure</b>          | 4000 psi (27.5 MPa)  |
| <b>Temperature</b>       | 90°F (at 1'000 rpm)<br>250°F (at 30 rpm)                   |
| <b>RPM</b>               | max. 1'000 rpm   |
| <b>Body</b>              | brass, nickel plated                                       |
| <b>Inner part</b>        | stainless steel  |
| <b>Seal</b>              | O-ring NBR<br>(optional: EPDM or FKM)                      |
| <b>Bearing</b>           | 2x radial ball bearings<br>1x thrust ball bearing          |
| <b>Throughput medium</b> | pH 3-12<br>filtered 10 microns<br>compressed air (290 psi) |

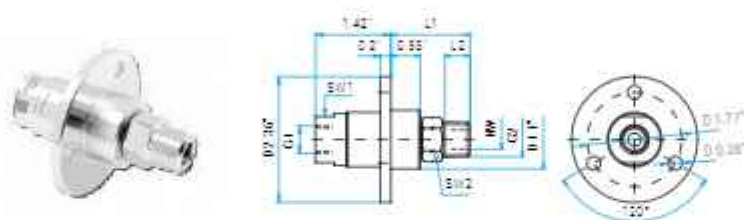
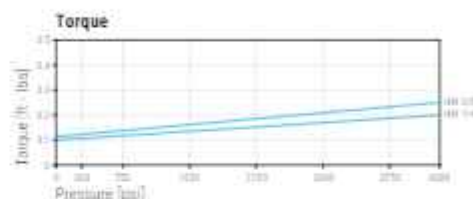
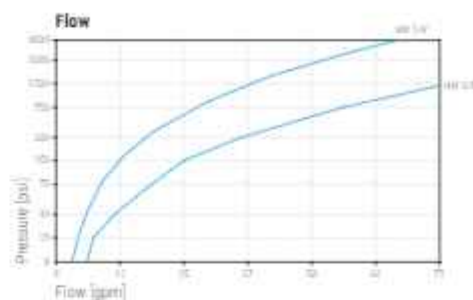

### DGF

| Part No. | G1 (F)    | G2 (M)    | NW   | SW1  | SW2  | L1   | L2   | Weight  |
|----------|-----------|-----------|------|------|------|------|------|---------|
| 35.051   | 1/4" NPTF | 1/4" NPTM | 1/4" | 0.87 | 0.67 | 1.45 | 0.43 | 10.4 oz |
| 35.053   | 1/4" NPTF | 3/8" NPTM | 1/4" | 0.87 | 0.75 | 1.49 | 0.47 | 11.0 oz |
| 35.063   | 1/4" NPTF | G3/8" M   | 1/4" | 0.87 | 0.75 | 1.49 | 0.39 | 12.0 oz |
| 35.080   | 1/4" NPTF | 1/8" NPTM | 1/4" | 0.87 | 0.39 | 1.17 | 0.31 | 9.8 oz  |
| 35.151   | 3/8" NPTF | 1/4" NPTM | 1/4" | 0.87 | 0.67 | 1.45 | 0.43 | 11.0 oz |
| 35.153   | 3/8" NPTF | 3/8" NPTM | 1/4" | 0.87 | 0.75 | 1.49 | 0.47 | 10.4 oz |
| 35.163   | 3/8" NPTF | G3/8" M   | 1/4" | 0.87 | 0.75 | 1.49 | 0.39 | 11.6 oz |
| 35.180   | 3/8" NPTF | 1/8" NPTM | 1/4" | 0.87 | 0.39 | 1.17 | 0.31 | 9.5 oz  |
| 35.653   | 3/8" NPTF | 3/8" NPTM | 3/8" | 0.87 | 0.75 | 1.49 | 0.47 | 11.3 oz |

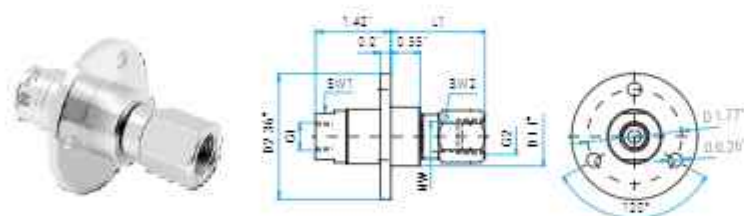

| Part No. | G1 (F)    | G2 (F)    | NW   | SW1  | SW2  | L1   | Weight  |
|----------|-----------|-----------|------|------|------|------|---------|
| 35.052   | 1/4" NPTF | 1/4" NPTF | 1/4" | 0.87 | 0.75 | 1.65 | 11.0 oz |
| 35.054   | 1/4" NPTF | 3/8" NPTF | 1/4" | 0.87 | 0.87 | 1.75 | 11.0 oz |
| 35.152   | 3/8" NPTF | 1/4" NPTF | 1/4" | 0.87 | 0.75 | 1.65 | 11.0 oz |
| 35.154   | 3/8" NPTF | 3/8" NPTF | 1/4" | 0.87 | 0.87 | 1.75 | 11.0 oz |

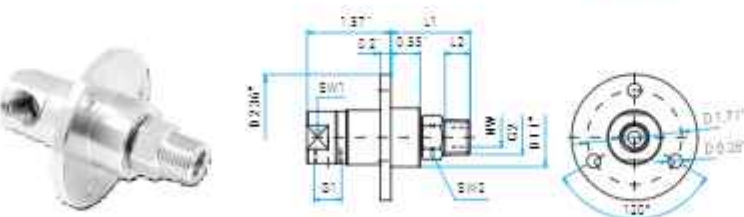

### DGF 90°

| Part No. | G1 (F)    | G2 (M)    | NW   | SW1  | SW2  | L1   | L2   | Weight  |
|----------|-----------|-----------|------|------|------|------|------|---------|
| 35.351   | 1/4" NPTF | 1/4" NPTM | 1/4" | 0.87 | 0.67 | 1.45 | 0.43 | 13.0 oz |
| 35.353   | 1/4" NPTF | 3/8" NPTM | 1/4" | 0.87 | 0.75 | 1.49 | 0.47 | 13.0 oz |

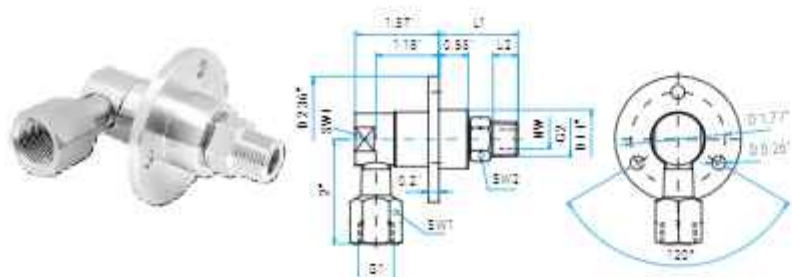

| Part No. | G1 (F)    | G2 (M)    | NW   | SW1  | SW2  | L1   | L2   | Weight  |
|----------|-----------|-----------|------|------|------|------|------|---------|
| 35.453   | 3/8" NPTF | 3/8" NPTM | 1/4" | 0.87 | 0.75 | 1.49 | 0.47 | 13.0 oz |
| 35.463   | 3/8" NPTF | G3/8" M   | 1/4" | 0.87 | 0.75 | 1.49 | 0.39 | 12.9 oz |

### Legend

M. = metric thrust, ...M = male, F = female, B = gas pipe thrust, R = gas pipe thrust optional, QV = quick connects  
 SW = profiling fitting, D = diameter, L = length, NW = nominal width, SW = swivel size

### Additional Seal Options available

EPDM (E) or FKM/Viton (V). Please indicate letter of seal material after part number.  
 Minimum orders apply.



- ✓ High speed, triple bearing systems
- ✓ Seal failure warning, through weep holes
- ✓ Stainless steel
- ✓ Maintenance free



## Application

High pressure cleaning technology, parts washers, tire cleaners, high rpm

### TECHNICAL DATA

|                          |  |
|--------------------------|--|
| <b>Pressure</b>          | 2500 psi (17 MPa)  |
| <b>Temperature</b>       | 40°F - 250°F   |
| <b>RPM</b>               | max. 2'000 rpm   |
| <b>Body</b>              | DXL: brass, nickel plated<br>DXLI: stainless steel           |
| <b>Inner part</b>        | stainless steel  |
| <b>Seal</b>              | ceramic  |
| <b>Bearing</b>           | 2x radial ball bearings<br>1x thrust ball bearing            |
| <b>Throughput medium</b> | pH 9 - 12<br>filtered 10 microns<br>compressed air (290 psi) |

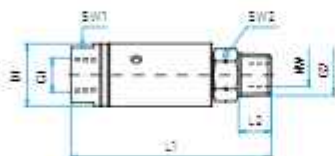
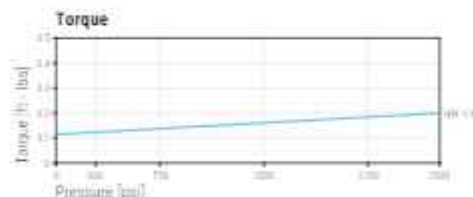
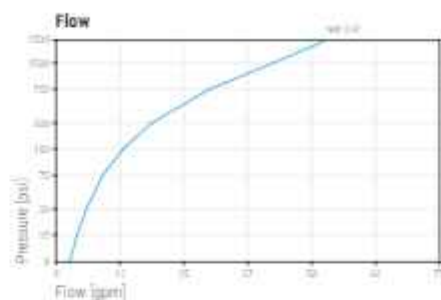

| DXL      |          | DXLI      |           |      |      |      |      |      |      |        |  |
|----------|----------|-----------|-----------|------|------|------|------|------|------|--------|--|
| Part No. | Part No. | G1 (F)    | G2 (M)    | NW   | SW1  | SW2  | L1   | L2   | D1   | Weight |  |
| 36.051   | 36.056   | 1/4" NPTF | 1/4" NPTM | 1/4" | 0.67 | 0.67 | 3.10 | 0.43 | 0.98 | 6.7 oz |  |
| 36.053   | 36.058   | 1/4" NPTF | 3/8" NPTM | 1/4" | 0.87 | 0.75 | 3.14 | 0.47 | 0.98 | 7.2 oz |  |
| 36.063   | 36.068   | 1/4" NPTF | G3/8" M   | 1/4" | 0.87 | 0.75 | 3.14 | 0.39 | 0.98 | 6.9 oz |  |
| 36.080   | ---      | 1/4" NPTF | 1/8" NPTM | 1/4" | 0.87 | 0.39 | 2.83 | 0.31 | 0.98 | 6.2 oz |  |
| 36.151   | 36.156   | 3/8" NPTF | 1/4" NPTM | 1/4" | 0.87 | 0.67 | 3.10 | 0.43 | 0.98 | 6.5 oz |  |
| 36.153   | 36.158   | 3/8" NPTF | 3/8" NPTM | 1/4" | 0.87 | 0.75 | 3.14 | 0.47 | 0.98 | 6.8 oz |  |
| 36.163   | 36.168   | 3/8" NPTF | G3/8" M   | 1/4" | 0.87 | 0.75 | 3.14 | 0.39 | 0.98 | 6.7 oz |  |
| 36.180   | ---      | 3/8" NPTF | 1/8" NPTM | 1/4" | 0.87 | 0.39 | 2.83 | 0.31 | 0.98 | 6.8 oz |  |

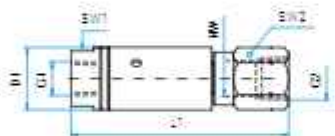

| Part No. | Part No. | G1 (F)    | G2 (F)    | NW   | SW1  | SW2  | L1   | D1   | Weight |
|----------|----------|-----------|-----------|------|------|------|------|------|--------|
| 36.052   | 36.057   | 1/4" NPTF | 1/4" NPTF | 1/4" | 0.87 | 0.75 | 3.30 | 0.98 | 7.5 oz |
| 36.054   | 36.059   | 1/4" NPTF | 3/8" NPTF | 1/4" | 0.87 | 0.67 | 3.42 | 0.98 | 7.8 oz |
| 36.152   | 36.157   | 3/8" NPTF | 1/4" NPTF | 1/4" | 0.87 | 0.75 | 3.30 | 0.98 | 6.7 oz |
| 36.154   | 36.159   | 3/8" NPTF | 3/8" NPTF | 1/4" | 0.87 | 0.67 | 3.42 | 0.98 | 7.5 oz |

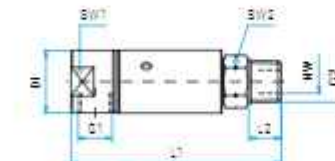

| DXL 90°  |          | DXLI 90°  |           |      |      |      |      |      |      |        |
|----------|----------|-----------|-----------|------|------|------|------|------|------|--------|
| Part No. | Part No. | G1 (F)    | G2 (M)    | NW   | SW1  | SW2  | L1   | L2   | D1   | Weight |
| 36.351   | 36.356   | 1/4" NPTF | 1/4" NPTM | 1/4" | 0.87 | 0.67 | 3.25 | 0.43 | 0.98 | 7.1 oz |
| 36.353   | 36.358   | 1/4" NPTF | 3/8" NPTM | 1/4" | 0.87 | 0.75 | 3.30 | 0.47 | 0.98 | 7.1 oz |

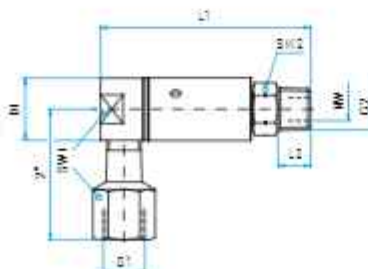

| Part No. | G1 (F)    | G2 (M)    | NW   | SW1  | SW2  | L1   | L2   | D1   | Weight |
|----------|-----------|-----------|------|------|------|------|------|------|--------|
| 36.453   | 3/8" NPTF | 3/8" NPTM | 1/4" | 0.67 | 0.75 | 3.30 | 0.47 | 0.98 | 6.5 oz |
| 36.463   | 3/8" NPTF | G3/8" M   | 1/4" | 0.67 | 0.75 | 3.30 | 0.39 | 0.98 | 9.5 oz |

|        |                     |
|--------|---------------------|
| 36.901 | Seal kit            |
| 36.903 | Seal kit + adhesive |

- ✓ For Steam
- ✓ High speed, triple bearing systems
- ✓ Flange for easy installation
- ✓ Seal failure warning through weep holes



## Application

Steam cleaner, self rotating applications

### TECHNICAL DATA

|                   |  |
|-------------------|--|
| Pressure          | 300 psi (2 MPa)                                    |
| Temperature       | 350°F  |
| RPM               | max. 1'000 rpm                                     |
| Body              | brass, nickel plated                               |
| Inner part        | stainless steel                                    |
| Seal              | ceramic  |
| Bearing           | 2x radial ball bearings<br>1x thrust ball bearings |
| Throughput medium | Steam<br>pH 9-12                                   |

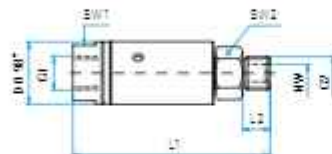
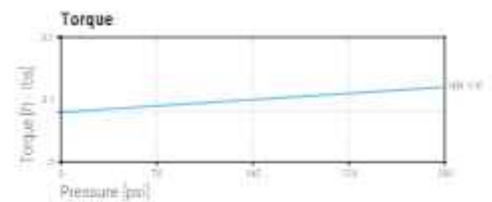

### DXLS

| Part No. | G1 (F)    | G2 (M)    | NW   | SW1  | SW2  | L1   | L2   | Weight |
|----------|-----------|-----------|------|------|------|------|------|--------|
| 36.093   | 1/4" NPTF | G3/8" M   | 1/4" | 0.87 | 0.75 | 3.15 | 0.47 | 7.2 oz |
| 36.095   | 1/4" NPTF | 1/8" NPTM | 1/4" | 0.87 | 0.39 | 2.83 | 0.31 | 6.2 oz |
| 36.193   | 3/8" NPTF | G3/8" M   | 1/4" | 0.87 | 0.75 | 3.15 | 0.47 | 7.8 oz |
| 36.195   | 3/8" NPTF | 1/8" NPTM | 1/4" | 0.87 | 0.39 | 2.83 | 0.31 | 6.8 oz |

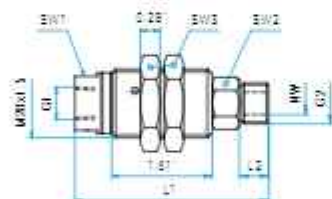

### DXGS

| Part No. | G1 (F)    | G2 (M)    | NW   | SW1  | SW2  | SW3  | L1   | L2   | Weight  |
|----------|-----------|-----------|------|------|------|------|------|------|---------|
| 37.093   | 1/4" NPTF | G3/8" M   | 1/4" | 0.87 | 0.75 | 1.34 | 3.15 | 0.47 | 10.2 oz |
| 37.095   | 1/4" NPTF | 1/8" NPTM | 1/4" | 0.87 | 0.39 | 1.34 | 2.83 | 0.31 | 9.2 oz  |
| 37.193   | 3/8" NPTF | G3/8" M   | 1/4" | 0.87 | 0.75 | 1.34 | 3.15 | 0.47 | 7.8 oz  |
| 37.195   | 3/8" NPTF | 1/8" NPTM | 1/4" | 0.87 | 0.39 | 1.34 | 2.83 | 0.31 | 8.8 oz  |

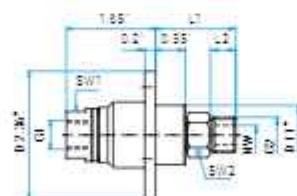

### DXFS

| Part No. | G1 (F)    | G2 (M)    | NW   | SW1  | SW2  | L1   | L2   | Weight  |
|----------|-----------|-----------|------|------|------|------|------|---------|
| 38.093   | 1/4" NPTF | G3/8" M   | 1/4" | 0.87 | 0.75 | 1.50 | 0.47 | 13.9 oz |
| 38.095   | 1/4" NPTF | 1/8" NPTM | 1/4" | 0.87 | 0.39 | 1.17 | 0.31 | 10.9 oz |
| 38.193   | 3/8" NPTF | G3/8" M   | 1/4" | 0.87 | 0.75 | 1.50 | 0.47 | 10.4 oz |
| 38.195   | 3/8" NPTF | 1/8" NPTM | 1/4" | 0.87 | 0.39 | 1.17 | 0.31 | 10.6 oz |

|        |                      |
|--------|----------------------|
| 36.913 | Seal kit for NW 1/4" |
|--------|----------------------|



#### Legend

M. = metric thread, ...M = male, F = female, B = gas pipe thread, R = gas pipe thread optional, QV = quick connect  
 SW = profiling fitting, D = diameter, L = length, NW = nominal width, SW = weep hole size

- ✓ High speed, triple bearing systems
- ✓ Bulkhead fitting for mounting
- ✓ Corrosion resistant
- ✓ Highest quality and precision
- ✓ Maintenance free



### Application

Surface cleaners, parts washers, tire cleaners, high rpm, self rotating applications

### TECHNICAL DATA

|                          |   |
|--------------------------|---|
| <b>Pressure</b>          | 2500 psi (17 MPa)   |
| <b>Temperature</b>       | 40°F - 250°F  |
| <b>RPM</b>               | max. 2'000 rpm  |
| <b>Body</b>              | DXG: brass, nickel plated<br>DXGI: stainless steel            |
| <b>Inner part</b>        | stainless steel   |
| <b>Seal</b>              | ceramic   |
| <b>Bearing</b>           | 2x radial ball bearings<br>1x thrust ball bearing             |
| <b>Throughput medium</b> | pH: 9 - 12<br>filtered 10 microns<br>compressed air (290 psi) |

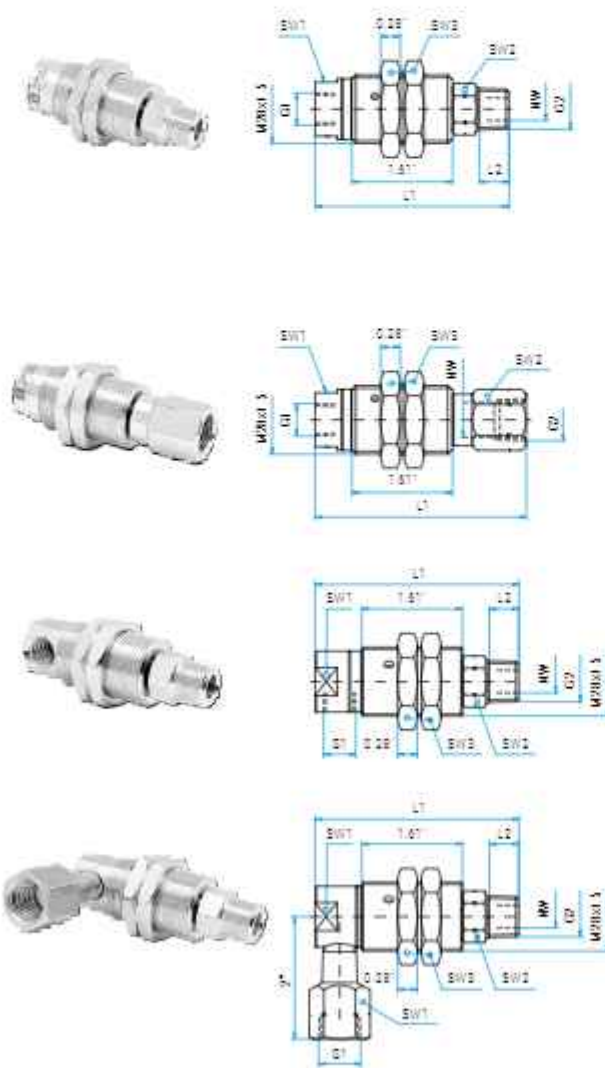
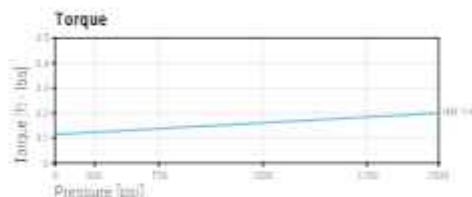
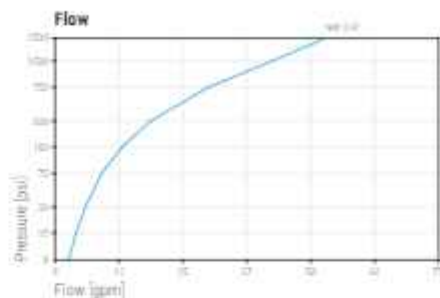

### DXG DXGI

| Part No. | Part No. | G1 (F)    | G2 (M)    | NW   | SW1  | SW2  | SW3   | L1   | L2   | Weight  |
|----------|----------|-----------|-----------|------|------|------|-------|------|------|---------|
| 37.051   | 37.056   | 1/4" NPTF | 1/4" NPTM | 1/4" | 0.67 | 0.67 | 1.34" | 3.10 | 0.43 | 9.9 oz  |
| 37.053   | 37.058   | 1/4" NPTF | 3/8" NPTM | 1/4" | 0.67 | 0.75 | 1.34" | 3.14 | 0.47 | 10.2 oz |
| 37.063   | 37.068   | 1/4" NPTF | 3/8" M    | 1/4" | 0.67 | 0.75 | 1.34" | 3.14 | 0.39 | 10.0 oz |
| 37.080   | ---      | 1/4" NPTF | 1/8" NPTM | 1/4" | 0.67 | 0.39 | 1.34  | 2.83 | 0.31 | 9.2 oz  |
| 37.151   | 37.156   | 3/8" NPTF | 1/4" NPTM | 1/4" | 0.67 | 0.67 | 1.34" | 3.10 | 0.43 | 9.6 oz  |
| 37.153   | 37.158   | 3/8" NPTF | 3/8" NPTM | 1/4" | 0.67 | 0.75 | 1.34" | 3.14 | 0.47 | 9.8 oz  |
| 37.163   | 37.168   | 3/8" NPTF | 3/8" M    | 1/4" | 0.67 | 0.75 | 1.34" | 3.14 | 0.39 | 9.7 oz  |
| 37.180   | ---      | 3/8" NPTF | 1/8" NPTM | 1/4" | 0.67 | 0.39 | 1.34  | 2.83 | 0.31 | 8.8 oz  |

| Part No. | Part No. | G1 (F)    | G2 (F)    | NW   | SW1  | SW2  | SW3   | L1   | Weight |
|----------|----------|-----------|-----------|------|------|------|-------|------|--------|
| 37.052   | 37.057   | 1/4" NPTF | 1/4" NPTF | 1/4" | 0.67 | 0.75 | 1.34" | 3.30 | 7.8 oz |
| 37.054   | 37.059   | 1/4" NPTF | 3/8" NPTF | 1/4" | 0.67 | 0.67 | 1.34" | 3.42 | 7.8 oz |
| 37.152   | 37.157   | 3/8" NPTF | 1/4" NPTF | 1/4" | 0.67 | 0.75 | 1.34" | 3.30 | 7.5 oz |
| 37.154   | 37.159   | 3/8" NPTF | 3/8" NPTF | 1/4" | 0.67 | 0.67 | 1.34" | 3.42 | 7.5 oz |

\* as DXGI 1.42

### DXG 90° DXGI 90°

| Part No. | Part No. | G1 (F)    | G2 (M)    | NW   | SW1  | SW2  | SW3   | L1   | L2   | Weight |
|----------|----------|-----------|-----------|------|------|------|-------|------|------|--------|
| 37.351   | 37.356   | 1/4" NPTF | 1/4" NPTM | 1/4" | 0.67 | 0.67 | 1.34" | 3.26 | 0.43 | 9.6 oz |
| 37.353   | 37.358   | 1/4" NPTF | 3/8" NPTM | 1/4" | 0.67 | 0.75 | 1.34" | 3.30 | 0.47 | 9.9 oz |

\* as DXGI 1.42

| Part No. | G1 (F)    | G2 (M)    | NW   | SW1  | SW2  | SW3  | L1   | L2   | Weight  |
|----------|-----------|-----------|------|------|------|------|------|------|---------|
| 37.453   | 3/8" NPTF | 3/8" NPTM | 1/4" | 0.67 | 0.75 | 1.34 | 3.30 | 0.47 | 13.6 oz |
| 37.463   | 3/8" NPTF | 3/8" M    | 1/4" | 0.67 | 0.75 | 1.34 | 3.30 | 0.39 | 13.4 oz |

|        |                     |
|--------|---------------------|
| 36.901 | Seal kit            |
| 36.903 | Seal kit + adhesive |

Legend

M. = metric thread, M = male, F = female, B = gas side thrust, R = gas side thrust control, QV = quick connects  
 SW = profiling fitting, Ø = diameter, L = length, NW = nominal width, SW = hexon size



- ✓ Flange for easy installation
- ✓ Seal failure warning, through weep holes
- ✓ Maintenance free
- ✓ Ceramic seals



## Application

High rpm, self rotating applications, surface cleaners, parts washers, the cleaners

### TECHNICAL DATA

|                          |  |
|--------------------------|--|
| <b>Pressure</b>          | 2500 psi (17 MPa)  |
| <b>Temperature</b>       | 40°F - 250°F   |
| <b>RPM</b>               | max. 2'000 rpm   |
| <b>Body</b>              | DXF: brass, nickel plated<br>DXFI: stainless steel           |
| <b>Inner part</b>        | stainless steel  |
| <b>Seal</b>              | ceramic  |
| <b>Bearing</b>           | 2x radial ball bearings<br>1x thrust ball bearing            |
| <b>Throughput medium</b> | pH 3 - 12<br>filtered 10 microns<br>compressed air (290 psi) |

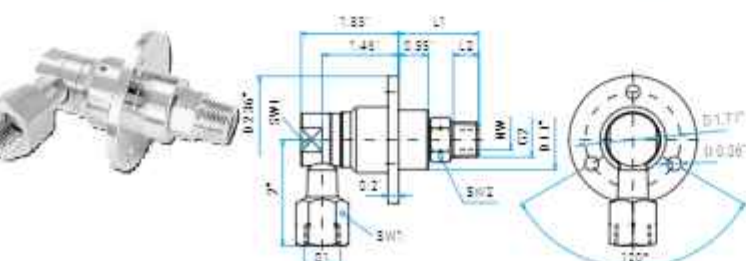
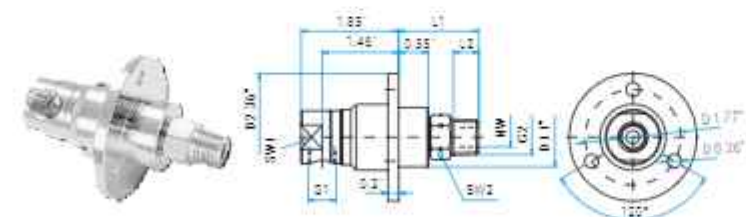
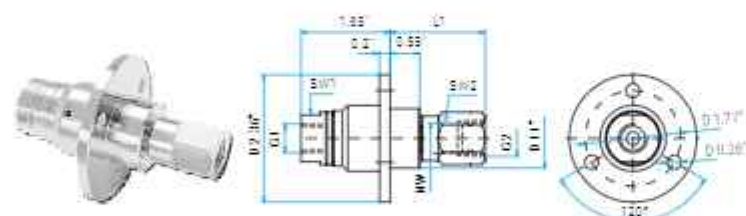
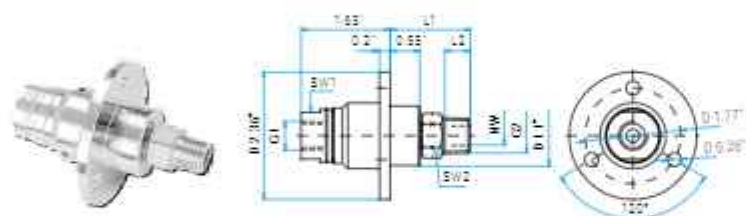
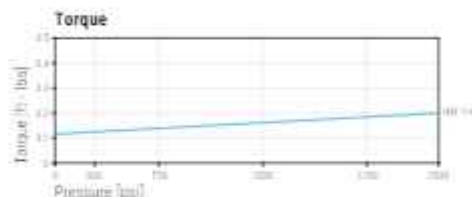
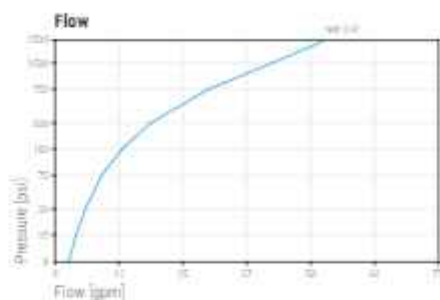

| DXF    |        | DXFI      |           | G1 (F) | G2 (M) | NW   | SW1  | SW2  | L1      | L2 | Weight |
|--------|--------|-----------|-----------|--------|--------|------|------|------|---------|----|--------|
| 38.051 | 38.056 | 1/4" NPTF | 1/4" NPTM | 1/4"   | 0.67   | 0.67 | 1.45 | 0.43 | 12.1 oz |    |        |
| 38.053 | 38.058 | 1/4" NPTF | 3/8" NPTM | 1/4"   | 0.67   | 0.75 | 1.49 | 0.47 | 13.9 oz |    |        |
| 38.063 | 38.068 | 1/4" NPTF | G3/8" M   | 1/4"   | 0.67   | 0.75 | 1.49 | 0.39 | 13.0 oz |    |        |
| 38.080 | ---    | 1/4" NPTF | 1/8" NPTM | 1/4"   | 0.67   | 0.39 | 1.17 | 0.31 | 10.9 oz |    |        |
| 38.151 | 38.156 | 3/8" NPTF | 1/4" NPTM | 1/4"   | 0.67   | 0.67 | 1.45 | 0.43 | 11.7 oz |    |        |
| 38.153 | 38.158 | 3/8" NPTF | 3/8" NPTM | 1/4"   | 0.67   | 0.75 | 1.49 | 0.47 | 13.5 oz |    |        |
| 38.163 | 38.168 | 3/8" NPTF | G3/8" M   | 1/4"   | 0.67   | 0.75 | 1.49 | 0.39 | 12.7 oz |    |        |
| 38.180 | ---    | 3/8" NPTF | 1/8" NPTM | 1/4"   | 0.67   | 0.39 | 1.17 | 0.31 | 10.6 oz |    |        |

| Part No. | Part No. | G1 (F)    | G2 (F)    | NW   | SW1  | SW2  | L1   | Weight  |
|----------|----------|-----------|-----------|------|------|------|------|---------|
| 38.052   | 38.057   | 1/4" NPTF | 1/4" NPTF | 1/4" | 0.67 | 0.75 | 1.65 | 10.0 oz |
| 38.054   | 38.059   | 1/4" NPTF | 3/8" NPTF | 1/4" | 0.67 | 0.67 | 1.76 | 10.4 oz |
| 38.152   | 38.157   | 3/8" NPTF | 1/4" NPTF | 1/4" | 0.67 | 0.75 | 1.65 | 9.6 oz  |
| 38.154   | 38.159   | 3/8" NPTF | 3/8" NPTF | 1/4" | 0.67 | 0.67 | 1.76 | 10.0 oz |

| DXF 90° |        | DXFI 90°  |           | G1 (F) | G2 (M) | NW   | SW1  | SW2  | L1      | L2 | Weight |
|---------|--------|-----------|-----------|--------|--------|------|------|------|---------|----|--------|
| 38.351  | 38.356 | 1/4" NPTF | 1/4" NPTM | 1/4"   | 0.67   | 0.67 | 1.45 | 0.43 | 12.5 oz |    |        |
| 38.353  | 38.358 | 1/4" NPTF | 3/8" NPTM | 1/4"   | 0.67   | 0.75 | 1.49 | 0.47 | 14.2 oz |    |        |

| Part No. | G1 (F)    | G2 (M)    | NW   | SW1  | SW2  | L1   | L2   | Weight  |
|----------|-----------|-----------|------|------|------|------|------|---------|
| 38.453   | 3/8" NPTF | 3/8" NPTM | 1/4" | 0.67 | 0.75 | 1.49 | 0.47 | 17.8 oz |
| 38.463   | 3/8" NPTF | G3/8" M   | 1/4" | 0.67 | 0.75 | 1.49 | 0.39 | 15.7 oz |

|        |                     |
|--------|---------------------|
| 36.901 | Seal kit            |
| 36.903 | Seal kit + adhesive |

### Legend

M. = metric thrust, ...M = male, F = female, B = gas pipe thrust, R = gas pipe thrust optional, QV = quick connects  
 SW = profiling fitting, D = diameter, L = length, NW = nominal width, SW = swivel size

- ✓ Quadruple bearing system
- ✓ Highest quality and precision
- ✓ Very low torque
- ✓ Maintenance free
- ✓ Side connection for weep capture
- ✓ Complete stainless steel construction



### Application

High rpm, high pressure, self rotating applications, parts washers, tire cleaners, HF cleaning technology

#### TECHNICAL DATA

|                          |  |
|--------------------------|--|
| <b>Pressure</b>          | Q500 psi (17 MPa)  |
| <b>Temperature</b>       | 250°F  |
| <b>RPM</b>               | mak. 2'000 rpm   |
| <b>Body</b>              | stainless steel  |
| <b>Inner part</b>        | stainless steel  |
| <b>Seal</b>              | ceramic  |
| <b>Bearing</b>           | 2x radial ball bearings<br>2x thrust ball bearings         |
| <b>Throughput medium</b> | pH 3-12<br>filtered 10 microns<br>compressed air (290 psi) |

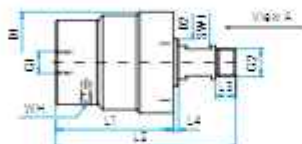
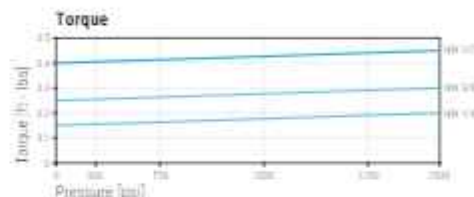
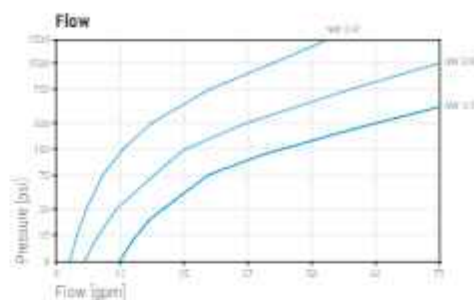

#### DXTI

| Part No. | G1 (F)    | G2 (M)  | NW   | SW1  | L1   | L2   | L3   | D1   | D2   | TK   | Weight |         |
|----------|-----------|---------|------|------|------|------|------|------|------|------|--------|---------|
| 39.063   | 1/4" NPTF | G3/8" M | 1/4" | 0.64 | 2.76 | 4.28 | 0.48 | 0.72 | 2.40 | 1.12 | 1.77   | 45.5 oz |
| 39.663   | 3/8" NPTF | G3/8" M | 3/8" | 0.64 | 2.88 | 4.36 | 0.48 | 0.72 | 2.40 | 1.12 | 1.77   | 45.2 oz |

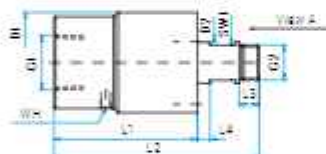

#### DXTI

| Part No. | G1 (F)    | G2 (M)  | NW   | SW1  | L1   | L2   | L3   | D1   | D2   | TK   | Weight  |
|----------|-----------|---------|------|------|------|------|------|------|------|------|---------|
| 39.865   | 1/2" NPTF | G1/2" M | 1/2" | 0.84 | 3.44 | 4.92 | 0.48 | 2.40 | 1.12 | 1.97 | 59.0 oz |
| 39.907   | 3/4" NPTF | G1/2" M | 1/2" | 0.84 | 3.44 | 4.92 | 0.48 | 2.40 | 1.12 | 1.97 | 57.9 oz |
| 39.905   | 1" NPTF   | G1/2" M | 1/2" | 0.84 | 3.44 | 4.92 | 0.48 | 2.40 | 1.12 | 1.97 | 55.9 oz |

WH (weep hole)

Optional: Pipes for weep hole



Part No. 902.745

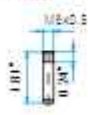

Part No. 902.769



|        |                      |
|--------|----------------------|
| 36.901 | Seal kit for NW 1/4" |
| 36.914 | Seal kit for NW 3/8" |
| 36.915 | Seal kit for NW 1/2" |

**Legend**

M. = metric thrust, M = male, F = female, B = gas pipe thrust, R = gas pipe thrust control, QV = quick connects, SW = profiling fitting, D = diameter, L = length, NW = nominal width, SW = wrench size

- ✓ Triple bearing system
- ✓ Seal failure warning, through weep holes
- ✓ Stainless steel
- ✓ Maintenance free
- ✓ Carbide seals



### Application

High pressure cleaning technology; parts washers, tire cleaners, high speed

### TECHNICAL DATA

|                          |  |
|--------------------------|--|
| <b>Pressure</b>          | 4000 psi (27.5 MPa)  |
| <b>Temperature</b>       | 250°F  |
| <b>RPM</b>               | max. 2'000 rpm   |
| <b>Body</b>              | DYL: brass, nickel plated<br>DYLH: stainless steel           |
| <b>Inner part</b>        | stainless steel  |
| <b>Seal</b>              | carbide  |
| <b>Bearing</b>           | 2x radial ball bearings<br>1x thrust ball bearing            |
| <b>Throughput medium</b> | pH 9 - 12<br>filtered 10 microns<br>compressed air (290 psi) |

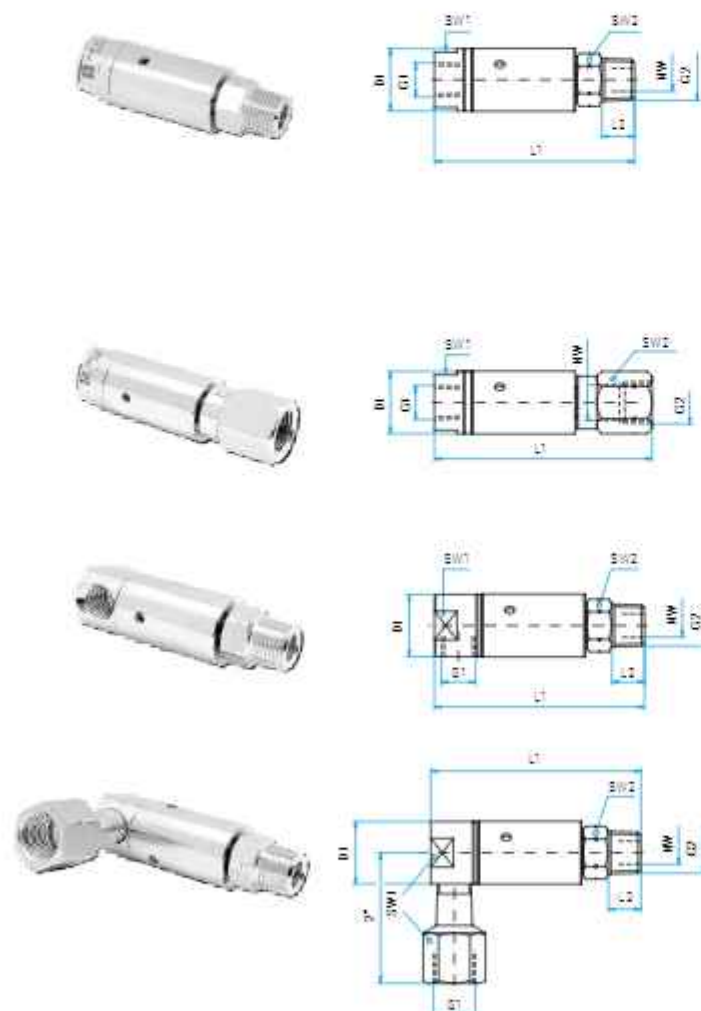
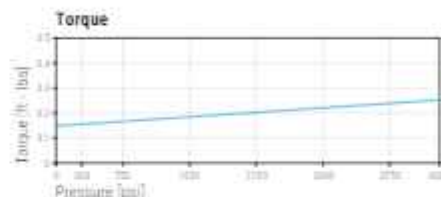
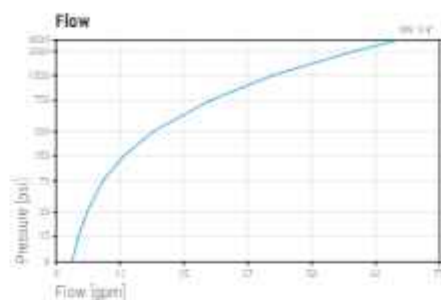

| DYL      |          | DYLH      |           |      |      |      |      |      |      |        |  |
|----------|----------|-----------|-----------|------|------|------|------|------|------|--------|--|
| Part No. | Part No. | G1 (F)    | G2 (M)    | NW   | SW1  | SW2  | L1   | L2   | D1   | Weight |  |
| 56.051   | 56.056   | 1/4" NPTF | 1/4" NPTM | 1/4" | 0.87 | 0.67 | 3.10 | 0.43 | 0.98 | 7.5 oz |  |
| 56.053   | 56.058   | 1/4" NPTF | 3/8" NPTM | 1/4" | 0.87 | 0.75 | 3.14 | 0.47 | 0.98 | 7.5 oz |  |
| 56.063   | 56.068   | 1/4" NPTF | G3/8" M   | 1/4" | 0.87 | 0.75 | 3.14 | 0.39 | 0.98 | 7.6 oz |  |
| 56.080   | ---      | 1/4" NPTF | 1/8" NPTM | 1/4" | 0.87 | 0.39 | 2.83 | 0.31 | 0.98 | 6.2 oz |  |
| 56.151   | 56.156   | 3/8" NPTF | 1/4" NPTM | 1/4" | 0.87 | 0.67 | 3.10 | 0.43 | 0.98 | 7.5 oz |  |
| 56.153   | 56.158   | 3/8" NPTF | 3/8" NPTM | 1/4" | 0.87 | 0.75 | 3.14 | 0.47 | 0.98 | 7.5 oz |  |
| 56.163   | 56.168   | 3/8" NPTF | G3/8" M   | 1/4" | 0.87 | 0.75 | 3.14 | 0.39 | 0.98 | 7.2 oz |  |
| 56.180   | ---      | 3/8" NPTF | 1/8" NPTM | 1/4" | 0.87 | 0.39 | 2.83 | 0.31 | 0.98 | 5.8 oz |  |

| Part No. | Part No. | G1 (F)    | G2 (F)    | NW   | SW1  | SW2  | L1   | D1   | Weight |
|----------|----------|-----------|-----------|------|------|------|------|------|--------|
| 56.052   | 56.057   | 1/4" NPTF | 1/4" NPTF | 1/4" | 0.87 | 0.75 | 3.30 | 0.98 | 8.2 oz |
| 56.054   | 56.059   | 1/4" NPTF | 3/8" NPTF | 1/4" | 0.87 | 0.87 | 3.42 | 0.98 | 8.2 oz |
| 56.152   | 56.157   | 3/8" NPTF | 1/4" NPTF | 1/4" | 0.87 | 0.75 | 3.30 | 0.98 | 8.2 oz |
| 56.154   | 56.159   | 3/8" NPTF | 3/8" NPTF | 1/4" | 0.87 | 0.87 | 3.42 | 0.98 | 8.2 oz |

| DYL 90°  |          | DYLH 90°  |           |      |      |      |      |      |      |        |  |
|----------|----------|-----------|-----------|------|------|------|------|------|------|--------|--|
| Part No. | Part No. | G1 (F)    | G2 (M)    | NW   | SW1  | SW2  | L1   | L2   | D1   | Weight |  |
| 56.351   | 56.356   | 1/4" NPTF | 1/4" NPTM | 1/4" | 0.87 | 0.67 | 3.25 | 0.43 | 0.98 | 7.5 oz |  |
| 56.353   | 56.358   | 1/4" NPTF | 3/8" NPTM | 1/4" | 0.87 | 0.75 | 3.30 | 0.47 | 0.98 | 7.5 oz |  |

| Part No. | G1 (F)    | G2 (M)    | NW   | SW1  | SW2  | L1   | L2   | D1   | Weight  |
|----------|-----------|-----------|------|------|------|------|------|------|---------|
| 56.453   | 3/8" NPTF | 3/8" NPTM | 1/4" | 0.87 | 0.75 | 3.30 | 0.47 | 0.98 | 10.7 oz |
| 56.463   | 3/8" NPTF | G3/8" M   | 1/4" | 0.87 | 0.75 | 3.30 | 0.39 | 0.98 | 10.7 oz |

|        |                     |
|--------|---------------------|
| 36.905 | Seal kit            |
| 36.906 | Seal kit + adhesive |

Legend  
 M = metric thrust, ...M = male, F = female, B = gas side thrust, R = gas side thrust optional, QV = quick connect  
 SW = profiling fitting, D = diameter, L = length, NW = nominal width, SW = swivel size



- ✓ Bulkhead fitting for mounting
- ✓ Corrosion resistant
- ✓ Highest quality and precision
- ✓ Maintenance free
- ✓ Carbide seals



### Application

Surface cleaners, parts washers, tire cleaners, high pressure, self rotating applications

### TECHNICAL DATA

|                          |  |
|--------------------------|--|
| <b>Pressure</b>          | 4000 psi (27.5 MPa)  |
| <b>Temperature</b>       | 250°F  |
| <b>RPM</b>               | mak. 2'000 rpm   |
| <b>Body</b>              | DYG: brass, nickel plated<br>DYGI: stainless steel         |
| <b>Inner part</b>        | stainless steel  |
| <b>Seal</b>              | carbide  |
| <b>Bearing</b>           | 2x radial ball bearings<br>1x thrust ball bearing          |
| <b>Throughput medium</b> | pH 3-12<br>filtered 10 microns<br>compressed air (290 psi) |

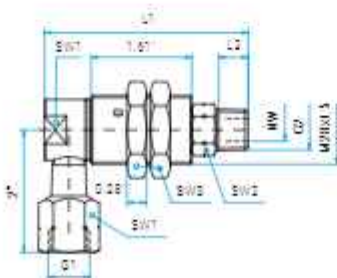
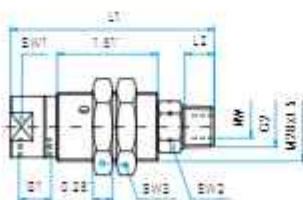
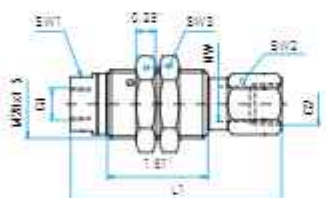
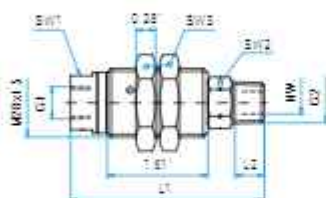
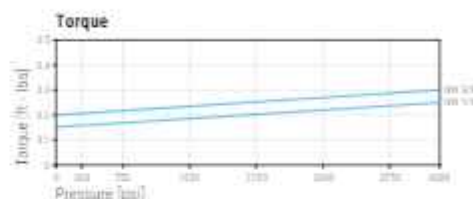
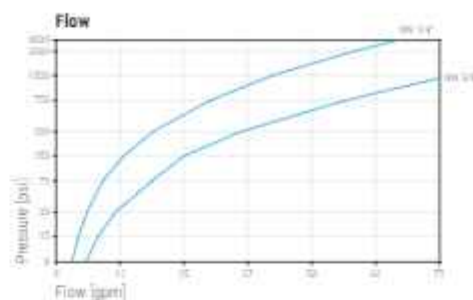

### DYG DYGI

| Part No. | Part No. | G1 (F)    | G2 (M)    | NW   | SW1  | SW2  | SW3   | L1   | L2   | Weight  |
|----------|----------|-----------|-----------|------|------|------|-------|------|------|---------|
| 57.051   | 57.056   | 1/4" NPTF | 1/4" NPTM | 1/4" | 0.67 | 0.67 | 1.34" | 3.10 | 0.43 | 6.5 oz  |
| 57.053   | 57.058   | 1/4" NPTF | 3/8" NPTM | 1/4" | 0.67 | 0.75 | 1.34" | 3.14 | 0.47 | 7.4 oz  |
| 57.063   | 57.068   | 1/4" NPTF | G3/8" M   | 1/4" | 0.67 | 0.75 | 1.34" | 3.14 | 0.39 | 10.6 oz |
| 57.080   | ---      | 1/4" NPTF | 1/8" NPTM | 1/4" | 0.67 | 0.39 | 1.34  | 2.83 | 0.31 | 9.2 oz  |
| 57.151   | 57.156   | 3/8" NPTF | 1/4" NPTM | 1/4" | 0.67 | 0.67 | 1.34" | 3.10 | 0.43 | 7.4 oz  |
| 57.153   | 57.158   | 3/8" NPTF | 3/8" NPTM | 1/4" | 0.67 | 0.75 | 1.34" | 3.14 | 0.47 | 6.5 oz  |
| 57.163   | 57.168   | 3/8" NPTF | G3/8" M   | 1/4" | 0.67 | 0.75 | 1.34" | 3.14 | 0.39 | 10.2 oz |
| 57.180   | ---      | 3/8" NPTF | 1/8" NPTM | 1/4" | 0.67 | 0.39 | 1.34  | 2.83 | 0.31 | 6.8 oz  |
| 57.653   | 57.658   | 3/8" NPTF | 3/8" NPTM | 3/8" | 0.67 | 0.75 | 1.34" | 3.13 | 0.47 | 7.6 oz  |

| Part No. | Part No. | G1 (F)    | G2 (F)    | NW   | SW1  | SW2  | SW3   | L1   | Weight |
|----------|----------|-----------|-----------|------|------|------|-------|------|--------|
| 57.052   | 57.057   | 1/4" NPTF | 1/4" NPTF | 1/4" | 0.67 | 0.75 | 1.34" | 3.30 | 8.2 oz |
| 57.054   | 57.059   | 1/4" NPTF | 3/8" NPTF | 1/4" | 0.67 | 0.67 | 1.34" | 3.42 | 8.6 oz |
| 57.152   | 57.157   | 3/8" NPTF | 1/4" NPTF | 1/4" | 0.67 | 0.75 | 1.34" | 3.30 | 7.8 oz |
| 57.154   | 57.159   | 3/8" NPTF | 3/8" NPTF | 1/4" | 0.67 | 0.67 | 1.34" | 3.42 | 8.2 oz |
| 57.654   | 57.659   | 3/8" NPTF | 3/8" NPTF | 3/8" | 0.67 | 0.67 | 1.34" | 3.42 | 7.4 oz |

\*at DYG: 1.42

### DYG 90° DYGI 90°

| Part No. | Part No. | G1 (F)    | G2 (M)    | NW   | SW1  | SW2  | SW3   | L1   | L2   | Weight  |
|----------|----------|-----------|-----------|------|------|------|-------|------|------|---------|
| 57.351   | 57.356   | 1/4" NPTF | 1/4" NPTM | 1/4" | 0.67 | 0.67 | 1.34" | 3.26 | 0.43 | 10.7 oz |
| 57.353   | 57.358   | 1/4" NPTF | 3/8" NPTM | 1/4" | 0.67 | 0.75 | 1.34" | 3.30 | 0.47 | 11.0 oz |

\*at DYG: 1.42

| Part No. | G1 (F)    | G2 (M)    | NW   | SW1  | SW2  | SW3  | L1   | L2   | Weight  |
|----------|-----------|-----------|------|------|------|------|------|------|---------|
| 57.453   | 3/8" NPTF | 3/8" NPTM | 1/4" | 0.67 | 0.75 | 1.34 | 3.30 | 0.47 | 10.7 oz |
| 57.463   | 3/8" NPTF | G3/8" M   | 1/4" | 0.67 | 0.75 | 1.34 | 3.30 | 0.39 | 14.0 oz |

|        |                                 |
|--------|---------------------------------|
| 36.905 | Seal kit for NW 1/4"            |
| 36.906 | Seal kit for NW 1/4" + adhesive |
| 36.908 | Seal Kit for NW 3/8"            |

Legend

M. = metric thread, .M = male, F = female, B = gas pipe thread, R = gas pipe thread conical, QV = quick connects  
 SW = profiling fitting, Ø = diameter, L = length, NW = nominal width, SW = hexagon size

- ✓ Flange for easy installation
- ✓ Seal failure warning, through weep holes
- ✓ Maintenance free
- ✓ Carbide seal system



## Application

Surface cleaners, parts washers, tire cleaners, high pressure, self rotating applications

### TECHNICAL DATA

|                          |  |
|--------------------------|--|
| <b>Pressure</b>          | 4000 psi (27.5 MPa)  |
| <b>Temperature</b>       | 250°F  |
| <b>RPM</b>               | mak. 2'000 rpm   |
| <b>Body</b>              | DYF: brass, nickel plated<br>DYFI: stainless steel           |
| <b>Inner part</b>        | stainless steel  |
| <b>Seal</b>              | carbide  |
| <b>Bearing</b>           | 2x radial ball bearings<br>1x thrust ball bearing            |
| <b>Throughput medium</b> | pH 3 - 12<br>filtered 10 microns<br>compressed air (290 psi) |

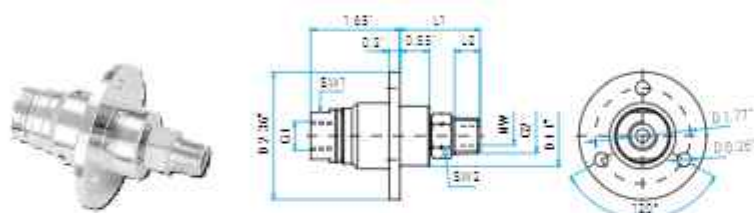
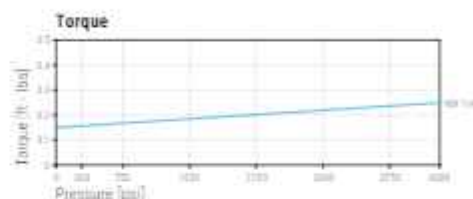
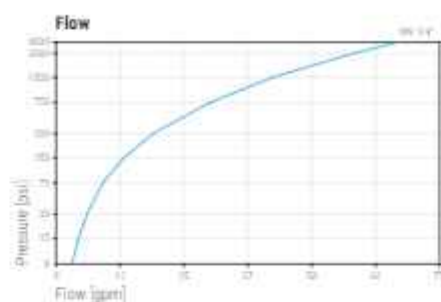

| DYF    |        | DYFI      |           | G1 (F) | G2 (M) | NW   | SW1  | SW2  | L1      | L2 | Weight |
|--------|--------|-----------|-----------|--------|--------|------|------|------|---------|----|--------|
| 58.051 | 58.056 | 1/4" NPTF | 1/4" NPTM | 1/4"   | 0.67   | 0.67 | 1.45 | 0.43 | 10.4 oz |    |        |
| 58.053 | 58.058 | 1/4" NPTF | 3/8" NPTM | 1/4"   | 0.67   | 0.75 | 1.49 | 0.47 | 11.0 oz |    |        |
| 58.063 | 58.068 | 1/4" NPTF | 3/8" M    | 1/4"   | 0.67   | 0.75 | 1.49 | 0.39 | 13.5 oz |    |        |
| 58.080 | ---    | 1/4" NPTF | 1/8" NPTM | 1/4"   | 0.67   | 0.39 | 1.17 | 0.31 | 10.9 oz |    |        |
| 58.151 | 58.156 | 3/8" NPTF | 1/4" NPTM | 1/4"   | 0.67   | 0.67 | 1.45 | 0.43 | 11.0 oz |    |        |
| 58.153 | 58.158 | 3/8" NPTF | 3/8" NPTM | 1/4"   | 0.67   | 0.75 | 1.49 | 0.47 | 10.4 oz |    |        |
| 58.163 | 58.168 | 3/8" NPTF | 3/8" M    | 1/4"   | 0.67   | 0.75 | 1.49 | 0.39 | 13.2 oz |    |        |
| 58.180 | ---    | 3/8" NPTF | 1/8" NPTM | 1/4"   | 0.67   | 0.39 | 1.17 | 0.31 | 10.6 oz |    |        |

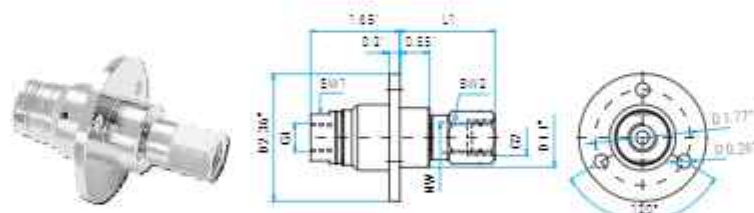

| Part No. | Part No. | G1 (F)    | G2 (F)    | NW   | SW1  | SW2  | L1   | Weight  |
|----------|----------|-----------|-----------|------|------|------|------|---------|
| 58.052   | 58.057   | 1/4" NPTF | 1/4" NPTF | 1/4" | 0.67 | 0.75 | 1.65 | 11.0 oz |
| 58.054   | 58.059   | 1/4" NPTF | 3/8" NPTF | 1/4" | 0.67 | 0.87 | 1.75 | 11.0 oz |
| 58.152   | 58.157   | 3/8" NPTF | 1/4" NPTF | 1/4" | 0.67 | 0.75 | 1.65 | 11.0 oz |
| 58.154   | 58.159   | 3/8" NPTF | 3/8" NPTF | 1/4" | 0.67 | 0.87 | 1.75 | 11.0 oz |

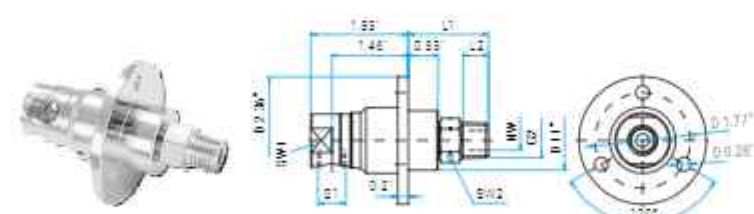

| DYF 90° |           | G1 (F)    | G2 (M) | NW   | SW1  | SW2  | L1   | L2      | Weight |
|---------|-----------|-----------|--------|------|------|------|------|---------|--------|
| 58.351  | 1/4" NPTF | 1/4" NPTM | 1/4"   | 0.67 | 0.67 | 1.45 | 0.43 | 13.0 oz |        |
| 58.353  | 1/4" NPTF | 3/8" NPTM | 1/4"   | 0.67 | 0.75 | 1.49 | 0.47 | 13.0 oz |        |

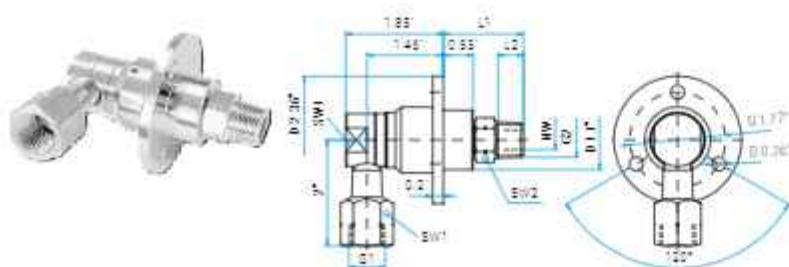

| Part No. | G1 (F)    | G2 (M)    | NW   | SW1  | SW2  | L1   | L2   | Weight  |
|----------|-----------|-----------|------|------|------|------|------|---------|
| 58.453   | 3/8" NPTF | 3/8" NPTM | 1/4" | 0.67 | 0.75 | 1.49 | 0.47 | 15.0 oz |
| 58.463   | 3/8" NPTF | 3/8" M    | 1/4" | 0.67 | 0.75 | 1.49 | 0.39 | 16.2 oz |

|        |                     |
|--------|---------------------|
| 36.905 | Seal kit            |
| 36.906 | Seal kit + adhesive |

### Legend

M. = metric thrust, ...M = male, F = female, B = gas pipe thrust, R = gas pipe thrust optional, QV = quick connects  
 SW = profiling fitting, D = diameter, L = length, NW = nominal width, SW = oration size

- ✓ Easy rotation under maximum pressure
- ✓ Flange for easy installation
- ✓ Sealed stainless steel bearings
- ✓ Maintenance free



### Application

High rpm, high pressure, self rotating applications, wall cleaners, parts washers

### TECHNICAL DATA

|                          |  |
|--------------------------|--|
| <b>Pressure</b>          | 5000 psi (35 MPa)  |
| <b>Temperature</b>       | 250°F  |
| <b>RPM</b>               | max. 2'000 rpm   |
| <b>Body</b>              | brass, nickel plated stainless steel                         |
| <b>Inner part</b>        | stainless steel  |
| <b>Seal</b>              | carbide  |
| <b>Bearing</b>           | 2x radial ball bearings<br>1x thrust ball bearing            |
| <b>Throughput medium</b> | pH 9 - 12<br>filtered 10 microns<br>compressed air (290 psi) |

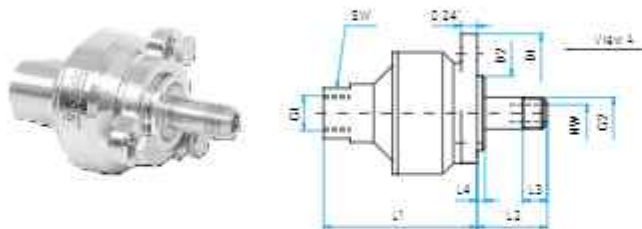
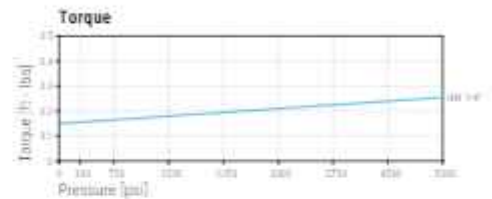
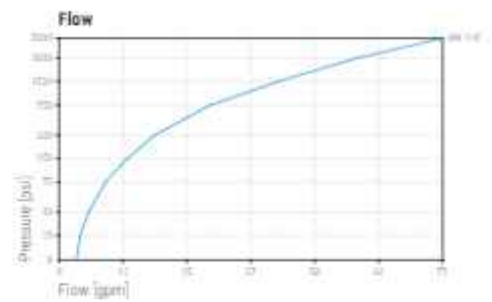

### DYW

| Part No. | G1 (F)    | G2 (M)  | NW   | SW   | L1   | L2   | L3   | L4   | D1   | D2   | Weight  |
|----------|-----------|---------|------|------|------|------|------|------|------|------|---------|
| 55.070   | 1/4" NPTF | M12x1 M | 1/4" | 0.75 | 2.28 | 1.04 | 0.35 | 0.12 | 2.36 | 1.10 | 16.4 oz |
| 55.170   | 3/8" NPTF | M12x1 M | 1/4" | 0.87 | 2.28 | 1.04 | 0.35 | 0.12 | 2.36 | 1.10 | 16.0 oz |

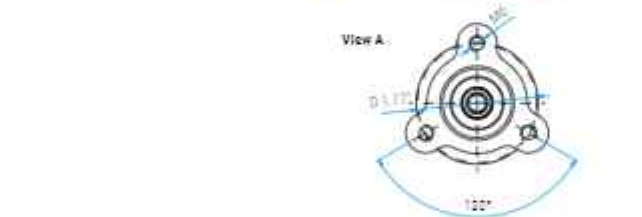

### DYW

| Part No. | G1 (QV)   | G2 (M)  | NW   | SW   | L1   | L2   | L3   | L4   | D1   | D2   | Weight  |
|----------|-----------|---------|------|------|------|------|------|------|------|------|---------|
| 55.220   | M21x1.5 M | M12x1 M | 1/4" | 0.75 | 2.28 | 1.04 | 0.35 | 0.12 | 2.36 | 1.10 | 15.7 oz |
| 55.270   | M22x1.5 M | M12x1 M | 1/4" | 0.79 | 2.28 | 1.04 | 0.35 | 0.12 | 2.36 | 1.10 | 16.0 oz |

|        |                     |
|--------|---------------------|
| 36.905 | Seal kit            |
| 36.906 | Seal kit + adhesive |

#### Legend

M. = metric thread, .M = male, F = female, B = gas pipe thread, R = gas pipe thread conical, QV = quick connects  
 SW = profiling fitting, D = diameter, L = length, NW = nominal width, CW = wrench size



- ✓ Complete stainless steel construction
- ✓ Seal failure warning, through weep holes
- ✓ Sealed stainless steel bearings
- ✓ Carbide seal system



### Application

High flow, high pressure, selfrotating applications, surface cleaners, parts washers

#### TECHNICAL DATA

|                          |  |
|--------------------------|--|
| <b>Pressure</b>          | DYCI: 5000 psi (35 MPa)<br>DYDI: 7300 psi (50 MPa)           |
| <b>Temperature</b>       | 250°F  |
| <b>RPM</b>               | max. 21000 rpm   |
| <b>Body</b>              | stainless steel  |
| <b>Inner part</b>        | stainless steel  |
| <b>Seal</b>              | carbide  |
| <b>Bearing</b>           | 2x radial ball bearings<br>1x thrust ball bearing            |
| <b>Throughput medium</b> | pH 9 - 12<br>filtered 10 microns<br>compressed air (290 psi) |

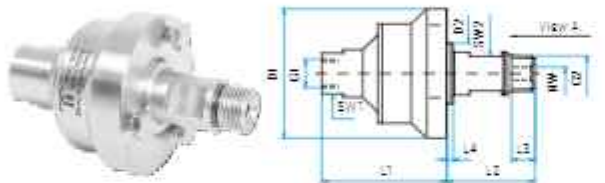
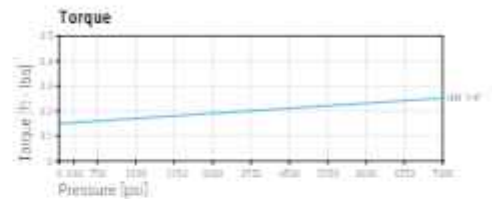
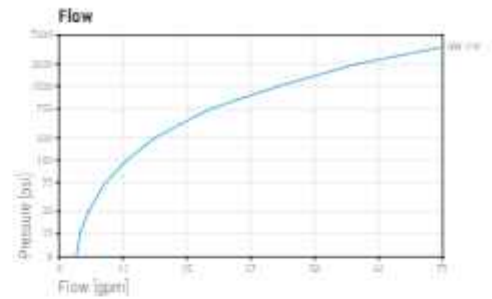

#### DYCI

| Part No. | G1 (F)    | G2 (M)    | NW   | SW1  | SW2  | L1   | L2   | L3   | L4   | D1   | D2   | Weight  |
|----------|-----------|-----------|------|------|------|------|------|------|------|------|------|---------|
| 55.051   | 1/4" NPTF | 1/4" NPTM | 1/4" | 0.87 | 0.63 | 2.26 | 1.46 | 0.39 | 0.12 | 2.36 | 1.10 | 23.0 oz |
| 55.063   | 1/4" NPTF | 3/8" M    | 1/4" | 0.87 | 0.63 | 2.26 | 1.46 | 0.47 | 0.12 | 2.36 | 1.10 | 23.0 oz |
| 55.153   | 3/8" NPTF | 3/8" NPTM | 1/4" | 0.87 | 0.63 | 2.26 | 1.46 | 0.49 | 0.12 | 2.36 | 1.10 | 23.0 oz |
| 55.163   | 3/8" NPTF | 3/8" M    | 1/4" | 0.87 | 0.63 | 2.26 | 1.46 | 0.47 | 0.12 | 2.36 | 1.10 | 23.0 oz |

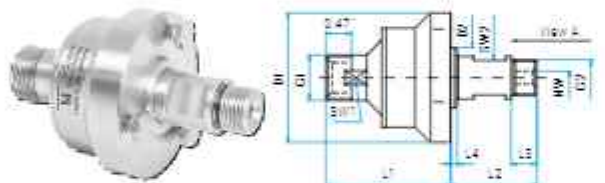

#### DYCI

| Part No. | G1 (GV)   | G2 (M) | NW   | SW1  | SW2  | L1   | L2   | L3   | L4   | D1   | D2   | Weight  |
|----------|-----------|--------|------|------|------|------|------|------|------|------|------|---------|
| 55.203   | M21x1.5 M | 3/8" M | 1/4" | 0.75 | 0.63 | 2.26 | 1.46 | 0.47 | 0.12 | 2.36 | 1.10 | 23.0 oz |
| 55.253   | M22x1.5 M | 3/8" M | 1/4" | 0.79 | 0.63 | 2.26 | 1.46 | 0.47 | 0.12 | 2.36 | 1.10 | 23.0 oz |

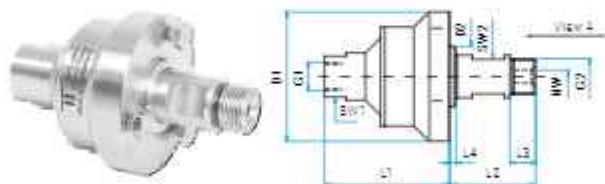

#### DYDI (7300 psi)

| Part No. | G1 (F)    | G2 (M) | NW   | SW1  | SW2  | L1   | L2   | L3   | L4   | D1   | D2   | Weight  |
|----------|-----------|--------|------|------|------|------|------|------|------|------|------|---------|
| 55.168   | 3/8" NPTF | 3/8" M | 1/4" | 0.87 | 0.63 | 2.26 | 1.46 | 0.47 | 0.12 | 2.36 | 1.10 | 23.0 oz |

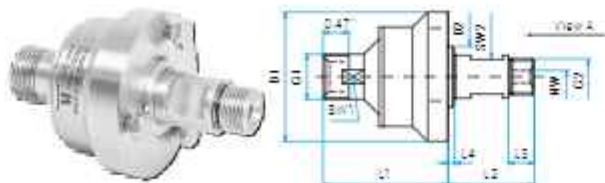

#### DYDI (7300 psi)

| Part No. | G1 (GV)   | G2 (M) | NW   | SW1  | SW2  | L1   | L2   | L3   | L4   | D1   | D2   | Weight  |
|----------|-----------|--------|------|------|------|------|------|------|------|------|------|---------|
| 55.263   | M22x1.5 M | 3/8" M | 1/4" | 0.79 | 0.63 | 2.26 | 1.46 | 0.47 | 0.12 | 2.36 | 1.10 | 23.0 oz |



|        |                          |
|--------|--------------------------|
| 36.905 | DYCI Seal kit            |
| 36.906 | DYCI Seal kit + adhesive |
| 36.909 | DYDI Seal kit (7300 psi) |

Legend

M. = metric thrust, ...M = male, F = female, B = gas pipe thrust, R = gas pipe thrust optional, GV = quick connects  
 SW = profiling fitting, D = diameter, L = length, NW = nominal width, SW = swivel size

- ✓ Quadruple bearing system
- ✓ Highest precision and quality
- ✓ Seal failure warning, through weep holes
- ✓ Sealed stainless steel bearings
- ✓ Carbide seals

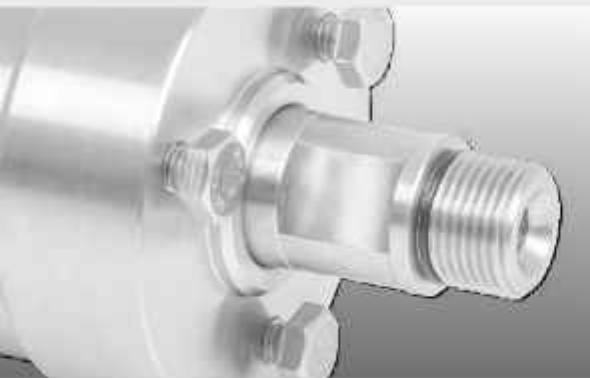

### Application

High pressure/rpm, thrust and radial force, self rotating applications, surface cleaners, parts washers

#### TECHNICAL DATA

|                          |   |
|--------------------------|---|
| <b>Pressure</b>          | DYT: 5000 psi (35 MPa)<br>DYU: 7300 psi (50 MPa)              |
| <b>Temperature</b>       | 250°F   |
| <b>RPM</b>               | max. 21000 rpm  |
| <b>Body</b>              | stainless steel   |
| <b>Inner part</b>        | stainless steel   |
| <b>Seal</b>              | carbide   |
| <b>Bearing</b>           | 2x radial ball bearings<br>2x thrust ball bearings            |
| <b>Throughput medium</b> | pH: 9 - 12<br>filtered 10 microns<br>compressed air (290 psi) |

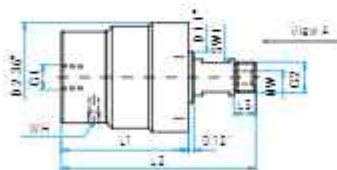
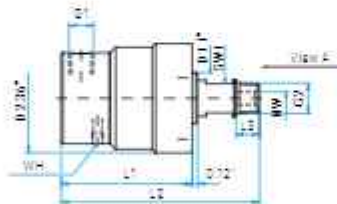
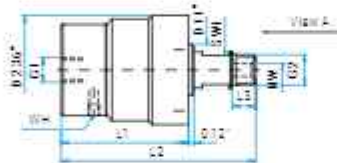
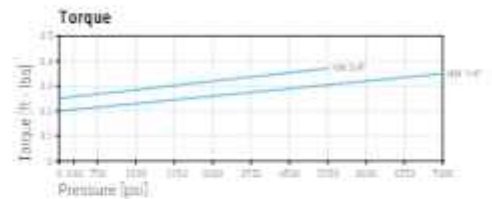
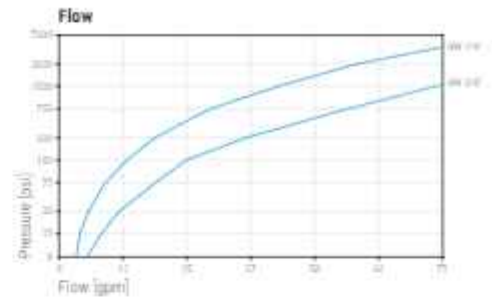

#### DYT

| Part No. | G1 (F)    | G2 (M)    | NW   | SW1  | L1   | L2   | L3   | Weight  |
|----------|-----------|-----------|------|------|------|------|------|---------|
| 59.051   | 1/4" NPTF | 1/4" NPTM | 1/4" | 0.63 | 2.76 | 4.21 | 0.39 | 51.7 oz |
| 59.053   | 1/4" NPTF | 3/8" NPTM | 1/4" | 0.63 | 2.76 | 4.21 | 0.43 | 51.7 oz |
| 59.063   | 1/4" NPTF | G3/8" M   | 1/4" | 0.63 | 2.76 | 4.21 | 0.47 | 50.1 oz |
| 59.151   | 3/8" NPTF | 1/4" NPTM | 1/4" | 0.63 | 2.63 | 4.29 | 0.39 | 53.7 oz |
| 59.153   | 3/8" NPTF | 3/8" NPTM | 1/4" | 0.63 | 2.63 | 4.29 | 0.43 | 53.7 oz |
| 59.163   | 3/8" NPTF | G3/8" M   | 1/4" | 0.63 | 2.63 | 4.29 | 0.47 | 49.9 oz |
| 59.653   | 3/8" NPTF | 3/8" NPTM | 3/8" | 0.63 | 2.63 | 4.29 | 0.43 | 53.7 oz |
| 59.663   | 3/8" NPTF | G3/8" M   | 3/8" | 0.63 | 2.63 | 4.36 | 0.48 | 53.7 oz |

#### DYT 90°

| Part No. | G1 (F)    | G2 (M)    | NW   | SW1  | L1   | L2   | L3   | Weight  |
|----------|-----------|-----------|------|------|------|------|------|---------|
| 59.351   | 1/4" NPTF | 1/4" NPTM | 1/4" | 0.63 | 3.63 | 4.29 | 0.47 | 45.9 oz |
| 59.363   | 1/4" NPTF | G3/8" M   | 1/4" | 0.63 | 3.63 | 4.29 | 0.47 | 45.9 oz |
| 59.453   | 3/8" NPTF | 3/8" NPTM | 1/4" | 0.63 | 2.63 | 4.29 | 0.43 | 53.7 oz |
| 59.463   | 3/8" NPTF | G3/8" M   | 1/4" | 0.63 | 2.63 | 4.29 | 0.47 | 50.6 oz |
| 59.902   | 3/4" NPTF | G3/8" M   | 3/8" | 0.63 | 3.62 | 5.08 | 0.47 | 61.7 oz |

#### DYU (7300 psi)

| Part No. | G1 (F)    | G2 (M)  | NW   | SW1  | L1   | L2   | L3   | Weight  |
|----------|-----------|---------|------|------|------|------|------|---------|
| 59.168   | 3/8" NPTF | G3/8" M | 1/4" | 0.63 | 2.63 | 4.29 | 0.43 | 50.7 oz |

WH (weep hole)

Optional: Pipes for weep hole

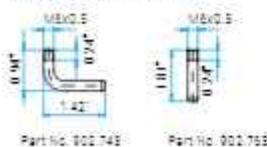

|        |                                    |
|--------|------------------------------------|
| 36.905 | DYT Seal kit NW 1/4"               |
| 36.906 | DYT Seal kit NW 1/4" + adhesive    |
| 36.908 | DYT Seal kit NW 3/8"               |
| 36.909 | DYU Seal kit NW 1/4" (7300 psi)    |
| 59.911 | DYT/DYU Bearing kit NW 1/4" + 3/8" |

**Legend**

M... = metric thrust, ...M = male, F = female, B = gas pipe thrust, R = gas pipe thrust conical, QV = quick connects  
 SW = profiling fitting, D = diameter, L = length, NW = nominal width, SW = insertion size

- ✓ Saltwater resistant
- ✓ With check valve
- ✓ Quadruple bearing system
- ✓ Carbide seal system
- ✓ Stainless steel



## Application

Underwater application (saltwater/freshwater), high rpm/pressure, thrust and radial forces

### TECHNICAL DATA

|                          |   |
|--------------------------|---|
| <b>Pressure</b>          | 5000 psi (35 MPa)   |
| <b>Temperature</b>       | 250°F   |
| <b>RPM</b>               | max. 2'000 rpm  |
| <b>Body</b>              | stainless steel   |
| <b>Inner part</b>        | stainless steel   |
| <b>Seal</b>              | carbide   |
| <b>Bearing</b>           | stainless steel<br>2x radial ball bearings<br>2x thrust ball bearings |
| <b>Throughput medium</b> | pH 9 - 12<br>filtered 10 microns<br>compressed air (290 psi)          |

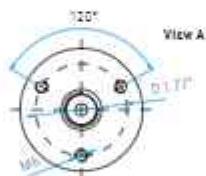
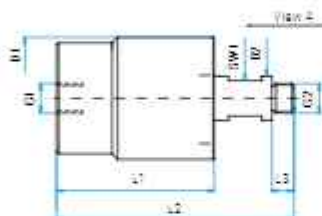
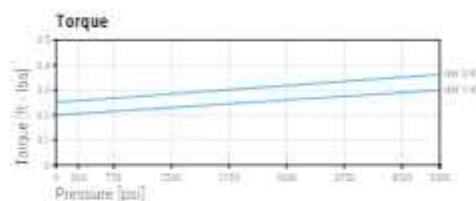
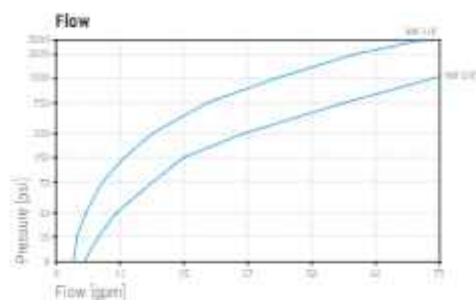

### DYKI

| Part No. | G1 (F)    | G2 (M)    | NW   | SW1  | L1   | L2   | L3   | D1   | D2   | Weight  |
|----------|-----------|-----------|------|------|------|------|------|------|------|---------|
| 54.051   | 1/4" NPTF | 1/4" NPTM | 1/4" | 0.63 | 2.80 | 4.21 | 0.47 | 2.17 | 0.79 | 2.54 oz |
| 54.063   | 1/4" NPTF | 3/8" M    | 1/4" | 0.63 | 2.80 | 4.21 | 0.47 | 2.17 | 0.79 | 2.54 oz |
| 54.163   | 3/8" NPTF | 3/8" M    | 1/4" | 0.63 | 2.87 | 4.29 | 0.47 | 2.17 | 0.79 | 2.56 oz |
| 54.653   | 3/8" NPTF | 3/8" NPTM | 3/8" | 0.63 | 2.87 | 4.33 | 0.51 | 2.17 | 0.79 | 2.56 oz |
| 54.663   | 3/8" NPTF | 3/8" M    | 3/8" | 0.63 | 2.87 | 4.29 | 0.47 | 2.17 | 0.79 | 2.56 oz |

|        |                  |
|--------|------------------|
| 36.916 | Seal kit NW 1/4" |
| 36.917 | Seal kit NW 3/8" |

#### Legend

M. = metric thrust, ...M = male, F = female, B = gas pipe thrust, R = gas pipe thrust optional, QV = quick connect, SW = profiling fitting, D = diameter, L = length, NW = nominal width, SW = swivel size



- ✓ Easily installed
- ✓ Light and solid
- ✓ Compact design

## Application

High pressure cleaners, high pressure hose reels, quick coupling

### TECHNICAL DATA

|                          |  |
|--------------------------|--|
| <b>Pressure</b>          | 3600 psi (25 MPa)<br>also available as 7300 psi            |
| <b>Temperature</b>       | 250°F  |
| <b>RPM</b>               | max. 30 rpm  |
| <b>Body</b>              | brass, nickel plated<br>plastic                            |
| <b>Inner part</b>        | stainless steel  |
| <b>Seal</b>              | O-ring NBR<br>(optional: EPDM or FKM)                      |
| <b>Throughput medium</b> | pH 3-12<br>filtered 10 microns<br>compressed air (290 psi) |

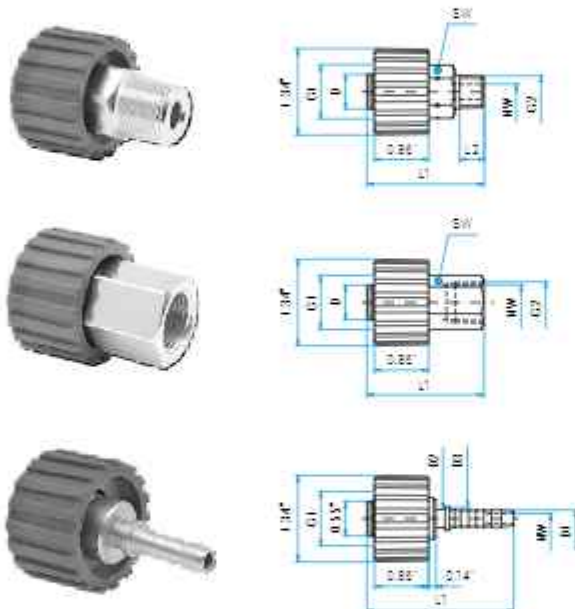
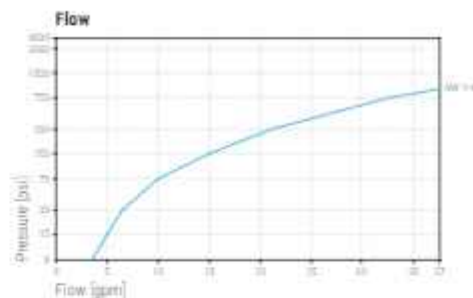

### QVS

| Part No. | G1 (GV)   | G2 (M)    | NW   | SW   | L1   | L2   | D    | Weight  | Color |
|----------|-----------|-----------|------|------|------|------|------|---------|-------|
| 50.151   | M22x1.5 F | 1/4" NPTM | 1/4" | 0.75 | 1.87 | 0.39 | 0.55 | 3.30 oz | blue  |
| 50.153   | M22x1.5 F | 3/8" NPTM | 1/4" | 0.75 | 1.91 | 0.51 | 0.55 | 3.30 oz | blue  |
| 50.171   | M22x1.5 F | 1/4" NPTM | 1/4" | 0.75 | 1.87 | 0.39 | 0.60 | 3.30 oz | blue  |
| 50.173   | M22x1.5 F | 3/8" NPTM | 1/4" | 0.75 | 1.91 | 0.51 | 0.60 | 3.30 oz | blue  |

| Part No. | G1 (GV)   | G2 (F)    | NW   | SW   | L1   | D    | Weight  | Color |
|----------|-----------|-----------|------|------|------|------|---------|-------|
| 50.152   | M22x1.5 F | 1/4" NPTF | 1/4" | 0.75 | 1.83 | 0.55 | 3.50 oz | blue  |
| 50.154   | M22x1.5 F | 3/8" NPTF | 1/4" | 0.67 | 1.83 | 0.55 | 4.10 oz | blue  |
| 50.172   | M22x1.5 F | 1/4" NPTF | 1/4" | 0.75 | 1.83 | 0.60 | 3.50 oz | blue  |
| 50.174   | M22x1.5 F | 3/8" NPTF | 1/4" | 0.67 | 1.83 | 0.60 | 4.10 oz | blue  |

| Part No. | G1 (GV)   | S1    | NW    | L1   | D1   | D2   | D3   | Weight  | Color |
|----------|-----------|-------|-------|------|------|------|------|---------|-------|
| 50.131   | M22x1.5 F | 1/4"  | 1/8"  | 2.26 | 0.25 | 0.29 | 0.39 | 2.30 oz | blue  |
| 50.132   | M22x1.5 F | 5/16" | 7/32" | 2.34 | 0.33 | 0.35 | 0.45 | 2.50 oz | blue  |
| 50.133   | M22x1.5 F | 3/8"  | 1/4"  | 2.40 | 0.39 | 0.42 | 0.53 | 2.10 oz | blue  |

#### Legend

M. = metric thread, M = male, F = female, B = gas side thread, R = gas side thread optional, QV = quick connects, SW = profiling fitting, D = diameter, L = length, NW = nominal width, SW = insertion size.

#### Additional Seal Options available

EPDM (E) or FKM/Viton (V). Please indicate letter of seal material after part number. Minimum orders apply.

- ✓ Brass, nickel plated or stainless steel
- ✓ Various thread configurations
- ✓ High precision

Different applications require different fitting types. Precision machined universal fitting to suite your application.



### VER (4000 psi / brass, nickel plated)

|                       |                  | male    |         |         |         |         |           | female  |         |
|-----------------------|------------------|---------|---------|---------|---------|---------|-----------|---------|---------|
|                       |                  | G1/4" M | G3/8" M | M16x1.5 | M21x1.5 | M22x1.5 | 3/8" NPTM | G1/4" F | G3/8" F |
| male                  | G1/4" M          |         | 52.004  |         |         | 52.221  |           | 52.011  |         |
|                       | G3/8" M          | 52.004  | 52.029  |         | 52.203  | 52.230  |           | 52.013  |         |
|                       | M21x1.5          |         | 52.203  |         | 52.208  | 52.209  |           | 52.202  | 52.204  |
|                       | M22x1.5          | 52.221  | 52.230  |         | 52.209  | 52.229  |           | 52.222  | 52.224  |
| female                | G1/4" F          | 52.011  | 52.013  |         | 52.202  | 52.222  |           | 52.012  | 52.014  |
|                       | G3/8" F          |         |         |         | 52.204  | 52.224  |           | 52.014  |         |
| Profile ring fittings | M14x1.5 M (08-L) |         |         |         | 52.205  | 52.225  |           |         |         |
|                       | M16x1.5 M (10-L) |         |         |         | 52.206  | 52.226  |           |         |         |
|                       | M18x1.5 M (12-L) |         |         |         | 52.207  | 52.227  |           |         |         |
| NPT                   | 1/4" NPTM        |         |         | 903.834 | 52.251  | 52.271  | 52.102    | 52.061  |         |
|                       | 1/4" NPTF        |         |         |         | 52.252  | 52.272  |           | 52.062  |         |
|                       | 3/8" NPTM        |         |         |         | 52.253  | 52.273  | 52.121    | 52.063  |         |
|                       | 3/8" NPTF        |         |         |         | 52.254  | 52.274  |           | 52.064  |         |

### VER (7300 psi / stainless steel)

|                       |                  | male    |         |         |         |         |         |         |           | female  |         |
|-----------------------|------------------|---------|---------|---------|---------|---------|---------|---------|-----------|---------|---------|
|                       |                  | G1/4" M | R1/4" M | G3/8" M | G1/2" M | M16x1.5 | M21x1.5 | M22x1.5 | 3/8" NPTM | G1/4" F | G3/8" F |
| male                  | G1/4" M          | 51.001  | 51.003  | 51.004  | 902.664 | 51.341  | 51.277  | 51.275  |           | 51.011  | 51.005  |
|                       | G3/8" M          | 51.004  | 51.009  |         |         | 51.343  | 51.279  | 51.280  |           | 51.012  | 38217   |
|                       | R1/2" M          |         |         |         | 904.645 |         |         |         |           |         |         |
|                       | M21x1.5          | 51.277  |         | 51.279  |         |         |         |         |           |         |         |
| female                | G1/4" F          | 51.011  | 51.019  | 51.012  |         | 51.342  |         |         |           |         |         |
|                       | G3/8" F          | 51.005  | 51.021  | 38217   |         | 51.344  |         | 51.224  |           |         | 51.022  |
| Profile ring fittings | M14x1.5 M (08-L) | 51.301  |         |         |         |         |         |         |           | 51.302  |         |
|                       | M16x1.5 M (10-L) | 51.321  |         |         |         |         |         |         |           | 51.322  |         |
|                       | M18x1.5 M (12-L) | 51.341  |         | 51.343  |         | 51.359  |         |         | 51.353    | 51.342  | 51.344  |
| NPT                   | 1/4" NPTM        | 51.103  |         |         |         |         |         | 51.278  |           | 51.061  |         |
|                       | 1/4" NPTF        |         |         |         |         |         |         |         |           |         |         |
|                       | 3/8" NPTM        |         |         |         |         | 51.353  |         | 51.272  |           |         |         |
|                       | 3/8" NPTF        | 51.129  | 51.129  |         |         | 51.354  |         |         |           |         |         |

Other versions or sizes upon request.

#### TECHNICAL DATA

|                 |  |
|-----------------|--|
| <b>Pressure</b> | 4000 psi (27.5 MPa)                    |
|                 | 7300 psi (50 MPa)                      |
| <b>Body</b>     | Brass nickel-plated or stainless steel |

#### Legend

M, ... = metric thread, ...M = male, ...F = female, B = gas pipe thread, R = gas pipe thread conical, QV = quick connect, SV = profile ring fitting  
 D = diameter, L = length, NW = nominal width, SW = wrench size, IN = male input, OUT = male output, RB = basic position

## ADAPTOR WITH SIEVE

- ✓ 100% stainless steel
- ✓ Different mesh sizes available
- ✓ Easy to dismantle and clean



These adaptors are ideal for washing systems with reclaim. The sieve decreases the amount of debris flowing through the gun and onto the vehicle. It is simple to dismantle and clean.



Mesh count 50



Mesh count 200



### Adaptor with sieve

4000 psi, stainless steel

| Part No. | IN / OUT              | Mesh count | SW    | Weight   |
|----------|-----------------------|------------|-------|----------|
| 53.011   | 3/8" NPTF / 3/8" NPTM | 50         | 0.87" | 0.13 lbs |
| 53.012   | 3/8" NPTF / 3/8" NPTM | 200        | 0.87" | 0.13 lbs |
| 53.015   | 1/2" NPTF / 1/2" NPTM | 50         | 1.06" | 0.13 lbs |
| 53.016   | 1/2" NPTF / 1/2" NPTM | 200        | 1.06" | 0.13 lbs |

## HP COUPLINGS

- ✓ Quick to assemble / disassemble

Mosmatic high quality couplings create a safe and tight connection. They are great for quick assembly and disassembly of guns, wands and hoses.



### Quick connect plug

5000 psi, stainless steel

| Part No. | Thread    | D     | NW   | SW    | Weight  |
|----------|-----------|-------|------|-------|---------|
| 70.025   | 1/4" NPTF | 0.47" | 1/4" | 0.67" | 1.00 oz |
| 70.026   | 1/4" NPTM | 0.47" | 1/4" | 0.67" | 1.00 oz |
| 70.027   | 3/8" NPTF | 0.6"  | 3/8" | 0.87" | 2.10 oz |
| 70.028   | 3/8" NPTM | 0.6"  | 3/8" | 0.87" | 2.10 oz |



### Quick connect coupler

5000 psi, stainless steel

| Part No. | Thread    | D     | NW   | SW    | Weight  |
|----------|-----------|-------|------|-------|---------|
| 70.015   | 1/4" NPTF | 0.47" | 1/4" | 0.87" | 2.10 oz |
| 70.016   | 1/4" NPTM | 0.47" | 1/4" | 0.87" | 2.80 oz |
| 70.017   | 3/8" NPTF | 0.6"  | 3/8" | 0.94" | 3.50 oz |
| 70.018   | 3/8" NPTM | 0.6"  | 3/8" | 0.94" | 3.50 oz |



### Quick connect plug reinforced

5000 psi, stainless steel

| Part No. | Thread    | D     | NW   | SW    | Weight  |
|----------|-----------|-------|------|-------|---------|
| 906.025  | 1/4" NPTM | 0.55" | 1/4" | 0.67" | 2.10 oz |
| 906.026  | 1/4" NPTF | 0.55" | 1/4" | 0.67" | 2.10 oz |

### Quick connect coupler reinforced

4000 psi, brass

| Part No. | Thread  | D     | NW   | SW | Weight   |
|----------|---------|-------|------|----|----------|
| 906.021  | G1/4" M | 0.55" | 1/4" | —  | 10.86 oz |



Ladies & Gentlemen

Thank you very much for your interest in our products. Please fill out this form and email or fax to your Mosmatic contact and we will process your inquiry promptly.

**1 CUSTOMER NUMBER**

|  |  |  |  |  |  |  |  |
|--|--|--|--|--|--|--|--|
|  |  |  |  |  |  |  |  |
|--|--|--|--|--|--|--|--|

Please enter your customer number for each inquiry.

New customer

**3 STYLE**

Rotating Unions are differentiated in terms of Style in axial and angular rotary feedthroughs. Please check the appropriate box.

Inline Version

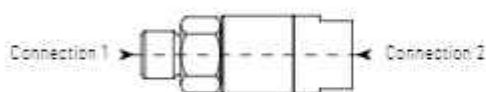

90° version

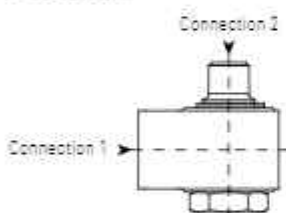

**4 ATTACHMENT**

Please check the appropriate box connection version.

- Flange connection
- Flange thread
- Bulkhead fitting
- not relevant

Specials

**6 SKETCH**

**2 CONTACT DETAILS**

Company

Street and No.

Postal code and city

Phone and Fax (in case of questions)

Contact person

Email

Date and Signature

**5 OPERATING CONDITIONS**

Application

Connections

Pressure (max. psi)

RPM (max. RPM)

Flow (gpm)

Medium

Fluid temperature (°F)

Loads: radial or axial

Operating time (hours/day)

Operating cycles

By multi-way rotary unions amount of Channels

Other factors or special features in the application

Max. dimensions (L x W x H)

Installation environment

Mounting position

Requested quantity

Drive

Price Range (approx. value)

Acceptance of any order and sale of any goods are expressly conditional upon the terms and conditions as listed here in. Any order or statement of intent to purchase any such goods, or any direction to proceed with engineering, procurement, manufacture or shipment shall constitute assent to said terms and conditions. Any additional or different terms or conditions set forth in Buyer's purchase order or similar communication are objected to and will not be binding upon Mosmatic Corporation, unless specifically assented to in writing by an authorized representative of Mosmatic Corporation management.

## 1. Prices

All prices stipulated or promulgated by Mosmatic Corporation are subject to change without notice. Prices do not include any present or future sales, use, excise, value added or similar taxes and, where applicable, such taxes shall be billed as a separate item and paid by Buyer.

## 2. Shipping

All orders are shipped via UPS Ground unless otherwise specified. Special packaging or handling charges may apply to oversize or custom orders. Please inspect your shipment immediately upon arrival. If your order is not received in satisfactory condition, keep all packaging material and notify Mosmatic Corporation within 48 hours. All sales are made ex point of shipment, and the Buyer assumes all risks with title passing upon delivery to carrier at point of shipment, irrespective of who selects carrier. Shipping dates given in advance of actual shipments are best estimates and shall not be deemed to represent fixed or guaranteed shipping dates. Mosmatic Corporation shall not be liable for failure to deliver or for delay in delivery or performance due to (a) a cause beyond its reasonable control or (b) an act of God, act or omission of Buyer, act of civil or military authority, governmental priority or other allocation or control, fire, strike or other labor difficulty, riot or other civil disturbance, delay in transportation or (c) any other commercial impracticability. Each shipment or delivery shall be deemed to have been sold under a separate and independent contract. If in the judgment of Mosmatic Corporation, the financial condition of the Buyer at the time of manufacture or shipment does not justify the terms of payment specified on order, Mosmatic Corporation reserves the right to require from Buyer full or partial payment or other adequate assurance of performance before manufacture or shipment. Mosmatic Corporation reserves the right to suspend its performance until such a payment or adequate assurance of performance has been received. If payment is not made when due, Buyer agrees to pay a charge on the amount past due at the rate of 1.5% per month (18% per annum) or the maximum lawful rate, whichever is less. Nothing here in shall be deemed to extend or otherwise modify Buyer's obligation to make payment when due.

## 3. Payments

First order terms are prepay or Credit Card. For credit applications please call 800-788-9880 or email [swivels@mosmatic.com](mailto:swivels@mosmatic.com). Checks are accepted as means of payment but shall not be regarded as settlement until they have been cleared. There is a minimum order amount of \$200.00 and the fee for drop shipment is \$20.00. For your convenience we accept VISA and Mastercard.

## 4. Termination

Buyer may terminate an order only by mutual agreement based on payment to Mosmatic Corporation of reasonable and proper termination charges.

## 5. Returns

No return of goods will be accepted without prior authorization from a representative of Mosmatic Corporation management. All returns must be accompanied by a Returned Merchandise Authorization (RMA) number provided by Mosmatic Corporation. RMA numbers are valid for 90 days only. Except due to manufacturer defects, all returns must be in resalable condition and are subject to a 15% restocking charge.

## 6. Limitation of Liability

Mosmatic Corporation's liability on any claim for loss or damage arising out of a contract or from the performance or breach thereof or connected with the supplying of goods, or their sale, resale, operation or use, warranty, tort (including negligence) or other grounds, shall not exceed the price allowable to such goods or part thereof involved in any claim. Mosmatic Corporation shall not under any circumstances be liable for any labor charges, special or consequential damages including, but not limited to, bodily injury, loss of profits or revenue, loss of use of any product or associated product, cost of capital, cost of substitute products, facilities or services, downtime costs or costs of claims arising from Buyer or Buyer's customers. Any technical or other advice or assistance furnished by Mosmatic Corporation, which concerns any goods supplied hereunder, will not subject Mosmatic Corporation to any liability, whether based on contract, warranty, tort (including negligence) or other grounds.

## 7. Limited Warranty

Mosmatic Corporation warrants that its product(s) (the „Product“) shall be free from defects in materials and workmanship under normal use, installation and maintenance in accordance with Mosmatic Corporation's specifications. If any failure to conform to this warranty is reported to Mosmatic Corporation within six months from the date of purchase by the original buyer, Mosmatic Corporation, upon being satisfied of the existence of such nonconformity, will, with exclusions (wear and tear) etc., correct same at its discretion by repairing or replacing the Product. This warranty does not cover damage resulting from mishandling in transit, vandalism, misuse, abuse, neglect, alteration, dismantling, acts of God or failure to exercise reasonable care in installing or maintaining the Product. This warranty applies only to the original buyers who purchased the Product directly from Mosmatic Corporation. To obtain service under this warranty, call our sales/service department at (800) 788-9880. NO EVENT WILL Mosmatic Corporation BE LIABLE FOR INCIDENTAL OR CONSEQUENTIAL DAMAGES. This warranty gives you specific legal rights, and you may have other rights which vary from state to state.

## 8. Availability

Not all products listed in this catalog are stocked by each service center.

## 9. Governing law

All orders are accepted by Seller at its mailing address in Bristol, Wisconsin, and shall be governed by and interpreted in accordance with the laws of the state of Wisconsin.

## General Information

- With the publication of this catalog, all previous catalogs and publications are no longer valid.
- We reserve the right to make technical modifications at any time without prior notification.
- For any special versions, manufactured to individual customer requirements, we decline any responsibility for their subsequent use and effects in operation.
- Validation of data and measurements exclude printing and typing errors.
- The details we provide are recommendations only, which we give to the best of our knowledge. Written confirmation of precise details can be obtained upon request.
- Mosmatic sells through a network of authorized dealers and representatives only.

## Use of your personal information

- We never sell or rent any of the information you provide us with to third parties.
- We use the information we collect for various purposes, including:
  - to complete your purchase transaction
  - to provide the services you requested
  - to send you our catalogues and offerings
  - to send you specials and updates per email
  - to contact you about the status of your order
- When you make a credit card transaction we collect your name, your billing address for the card, the card type, number and expiration date. We also collect information that allows us to ship your order, i.e. name, address and phone number of the intended recipient(s).

## For your safety

- For your own safety always use protection gear like safety glasses, gloves etc. when using our products connected to high pressure.
- Safety regulations and guidelines (Accident prevention rules) from the manufacturer of high pressure equipment are applicable when using our products.
- Nozzle installation according to nozzle manufacturer.
- Mosmatic products should only be installed by experienced users of high pressure equipment. The responsibility for the safe and effective use of Mosmatic products rest with the user.



[mosmatic.com](https://mosmatic.com)



[linkedin.com/company/mosmatic-ag](https://linkedin.com/company/mosmatic-ag)



[facebook.com/mosmatic](https://facebook.com/mosmatic)



[youtube.com/@mosmatic](https://youtube.com/@mosmatic)



Instagram

[instagram.com/mosmaticag](https://instagram.com/mosmaticag)



ME25



Mosmatic AB  
Oberhelfenschwilerstrasse 6  
CH-9126 Neckert, SWITZERLAND  
Phone +41 (0)71 375 64 64  
Email sales@mosmatic.com  
Internet www.mosmatic.com



Mosmatic Corporation  
8310-196th Ave., P.O. Box 400  
Bristol, WI 53104-0400 USA  
Phone +1-800-788-9880  
Email swivels@mosmatic.com  
Internet www.mosmatic.com



Mosmatic Australasia Pty Ltd.  
2/71 Richland Avenue  
Coopers Plains QLD 4106, AUSTRALIA  
Phone +61 (0)7 3161 3314  
Email australia@mosmatic.com  
Internet www.mosmatic.com



Mosmatic Canada Inc.  
6201 rue Marivaux  
Saint-Léonard, QC H1P 3H5, CANADA  
Phone +1-844-384-1602  
Office +1-438-384-1602  
Email canada@mosmatic.com  
Internet www.mosmatic.com